



Citrix ADC SDX 12.1

Contents

Introduction	4
Release Notes	4
Get started with the Management Service user interface	5
Data governance	10
Introduction to Citrix ADM service connect for NetScaler SDX appliances	13
Single bundle upgrade	16
Upgrading a Citrix® ADC instance	19
Manage and Monitor the SDX appliance	21
Creating SDX Administrative Domains	27
Managing RAID Disk Allocation on 22XXX Series SDX Appliances	29
SDX Licensing Overview	33
SDX Resource Visualizer	35
Manage interfaces	36
Jumbo Frames on SDX Appliances	40
Configuring SNMP on SDX Appliances	53
Configuring Syslog Notifications	58
Configuring Mail Notifications	60
Configuring SMS Notifications	60
Monitoring and Managing the Real-Time Status of Entities Configured on an SDX Appliance	61
Monitoring and Managing Events Generated on Citrix® ADC instances	67
Call Home Support for Citrix® ADC instances on an SDX Appliance	73
System Health Monitoring	75
Configuring System Notification Settings	80

Configuring the Management Service	80
Configuring Authentication and Authorization Settings	84
Configuring the External Authentication Server	89
Configuring Link Aggregation from the Management Service	95
Configuring a channel from the Management Service	95
Access Control Lists	97
Set up a cluster of Citrix® ADC instances	103
Configuring Cluster Link Aggregation	105
Configuring SSL Ciphers to Securely Access the Management Service	110
Back up and restore the configuration data of the SDX appliance	117
Performing Appliance Reset	122
Cascading External Authentication Servers	124
Provisioning Citrix® ADC instances	126
Manage crypto capacity	140
Provisioning Third-Party Virtual Machines	147
SECUREMATRIX GSB	147
Trend Micro InterScan Web Security	152
Websense Protector	153
BlueCat DNS/DHCP	157
CA Access Gateway	160
Palo Alto Networks VM-Series	162
Deploying a Citrix Secure Web Gateway™ Instance on an SDX Appliance	165
Deploy a Citrix SD-WAN VPX instance on a NetScaler SDX appliance	166
Bandwidth Metering in SDX	170

Configuring and Managing Citrix® ADC instances	175
Installing and Managing SSL Certificates	177
Allowing L2 Mode on a Citrix® ADC instance	182
Configuring VMACs on an Interface	183
Generating Partition MAC Addresses to Configure Admin Partition on a Citrix® ADC instance in the SDX Appliance	185
Change Management for VPX Instances	187
Monitoring Citrix® ADC instances	189
Using Logs to Monitor Operations and Events	193
Use Cases for Citrix NetScaler SDX Appliances	195
Consolidation When the Management Service and the Citrix® ADC instances are in the Same Network	196
Consolidation When the Management Service and the Citrix® ADC instances are in Different Networks	198
Consolidation Across Security Zones	200
Consolidation with Dedicated Interfaces for Each Instance	201
Consolidation With Sharing of a Physical Port by More Than One Instance	203
NITRO API	205
Obtaining the NITRO Package	206
.NET SDK	206
REST Web Services	211
How NITRO Works	217
Java SDK	218

Introduction

September 27, 2025

The NetScaler SDX appliance is a multitenant platform on which you can provision and manage multiple Citrix ADC virtual machines (instances). The SDX appliance addresses cloud computing and multitenancy requirements by allowing a single administrator to configure and manage the appliance and delegate the administration of each hosted instance to tenants. The SDX appliance enables the appliance administrator to provide each tenant the following benefits:

- One complete instance. Each instance has the following privileges:
 - Dedicated CPU and memory resources
 - A separate space for entities
 - The independence to run the release and build of their choice
 - Lifecycle independence
- A completely isolated network. Traffic meant for a particular instance is sent only to that instance.

The SDX appliance provides a Management Service that is preprovisioned on the appliance. The Management Service provides a user interface (HTTP and HTTPS modes) and an API to configure, manage, and monitor the appliance, the Management Service, and the instances. A Citrix® self-signed certificate is prepackaged for HTTPS support. Citrix recommends that you use the HTTPS mode to access the Management Service user interface.

Release Notes

September 27, 2025

Release notes describe the enhancements, changes, bug fixes, and known issues for a particular release or build of Citrix ADC software. The NetScaler SDX release notes are covered as a part of Citrix ADC release notes.

For detailed information about SDX 12.1 enhancements, known issues, and bug fixes, see [Citrix ADC Release Notes](#).

Get started with the Management Service user interface

September 27, 2025

To begin configuring, managing, and monitoring the appliance, the Management Service, and the virtual instances, connect to the Management Service user interface by using a browser. Then provision the virtual instances on the appliance.

You can connect to the Management Service user interface by using one of the following supported browsers:

- Internet Explorer
- Google Chrome
- Apple Safari
- Mozilla Firefox

Log on to the Management Service user interface

1. In your Web browser address field, type one of the following:

`http://Management Service IP Address`

or

`https://Management Service IP Address`

2. On the Login page, in User Name and Password, type the user name and password of the Management Service. The default user name is `nsroot`. If the earlier default password does not work, try typing the serial number of the appliance. The serial number bar code is available at the back of the appliance. Citrix recommends that you change the default password after initial configuration. For information about changing the admin password, see [Changing the Password of the Default User Account](#).
3. Click Show Options, and then do the following:
 - a) In the **Start in** list, select the page that must be displayed immediately after you log on to the user interface. The available options are Home, Monitoring, Configuration, Documentation, and Downloads. For example, if you want the Management Service to display the Configuration page when you log on, select **Configuration** in the **Start in** list.
 - b) In **Timeout**, type the length of time (in minutes, hours, or days) after which you want the session to expire. The minimum timeout value is 15 minutes.

The **Start in** and **Timeout** settings persist across sessions. Their default values are restored only after you clear the cache.

4. Click **Login** to log on to the Management Service user interface.

Initial setup wizard

You can use the Setup Wizard to complete all the first time configurations in a single flow.

You can use the wizard to configure network configuration details and system settings, change the default administrative password, and manage and update licenses.

You can also use this wizard to modify the network configuration details that you specified for the SDX appliance during initial configuration.

To access the wizard, navigate to **Configuration > System** and, under **Set Up Appliance**, click **Setup Wizard**. Enter values for the following parameters.

- **Interface:** Management interface that connects the appliance to a management workstation or network. Possible values: 0/1, 0/2. Default: 0/1.
- **Gateway:** IP address of the router that forwards traffic out of the appliance's subnet.
- Select the IPv4 check box if you want to use the IPv4 address for the Management Service and enter the details for the following parameters:
 - **Appliance Management IP:** The IPv4 address that is used to access the Management Service by using a Web browser.
 - **Netmask:** The subnet mask in which the SDX appliance is located.
- **DNS:** IPv4 address of the primary DNS server. IPv6 addresses are not supported for the primary DNS server.
- Select the IPv6 check box if you want to use the IPv6 address for the Management Service and enter the details for the following parameters:
 - **Management Service IP Address:** The IPv6 address that is used to access the Management Service by using a Web browser.
 - **Gateway IPv6 Address:** The IPv4 address of the router that forwards traffic out of the appliance's subnet.
- Select **Additional DNS** to add DNS server IP addresses as an extra DNS server apart from the primary DNS server. The IP addresses can be either IPv4 or IPv6.

← Network Configuration

Management Service

Interface*
0/1

Gateway*
10 . 102 . 103 . 1

IPv4

Appliance Management IP*
10 . 102 . 103 . 239

Netmask*
255 . 255 . 255 . 0

DNS
10 . 140 . 50 . 5

IPv6
 Additional DNS

Appliance Supportability

Configure Appliance supportability

OK Close

Important!

Citrix® recommends that you keep Appliance Supportability disabled for improved security. To disable appliance supportability, navigate to **System > Network Configuration** and clear the **Configure Appliance supportability** check box.

Under **System Settings**, you can specify that the Management Service and a Citrix ADC instance must communicate with each other only over a secure channel. You can also restrict access to the Management Service user interface. Clients can log on the Management Service user interface only by using https.

You can modify the time zone of the Management Service and the Citrix Hypervisor. The default time zone is UTC. You can change the Administrative password by selecting the **Change Password** check box and typing the new password.

Under Manage Licenses you can manage and allocate licenses. You can use your hardware serial number (HSN) or your license access code to allocate your licenses. Alternatively, if a license is already present on your local computer, you can upload it to the appliance.

Select the licenses on the appliance and click **Done** to complete the initial configuration.

Provision instances on an SDX appliance

You can provision one or more Citrix ADC or third-party instances on the SDX appliance by using the Management Service. The number of instances that you can install depends on the license you have purchased. If the number of instances added is equal to the number specified in the license, the Management Service does not allow provisioning more instances.

For information about provisioning third-party instances, see [Third-Party Virtual Machines](#).

Console access

You can access the console of Citrix ADC instances, the Management Service, Citrix Hypervisor, and third party VMs from the Management Service interface. This access is helpful in debugging and troubleshooting the instances hosted on the SDX appliance.

To access the console of VMs, navigate to the instance listing, select the VM from the list, and in the **Action** list, click **Console Access**.

To access the console of Management Service or Citrix Hypervisor, navigate to **Configuration > System**, and under **Console Access**, click **Management Service** or **Citrix Hypervisor** link.

Note: Internet Explorer browser does not support console access. Citrix recommends using the console access feature through Management Service HTTPS sessions only.

Management Service statistics

The dashboard now includes Management Service Statistics for monitoring the use of memory, CPU, and disk resources by the Management Service on the SDX appliance.

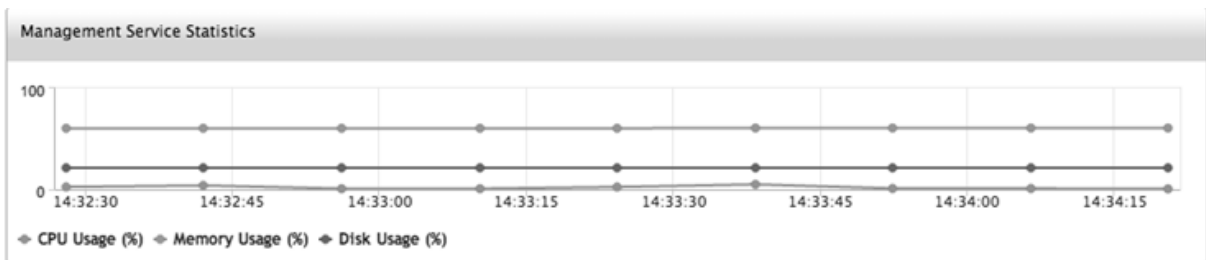

Single sign-on to the Management Service and the Citrix ADC instances

After logging on to the Management Service by using your user credentials, you do not have to provide the user credentials again for logging on to an instance. By default, the **Timeout** value is set to 30 minutes and the configuration tab is opened in a new browser window.

Manage the Home page

The Management Service Home page provides you with a high-level view of the performance of the SDX appliance and the instances provisioned on your appliance. The information about the SDX appliance and instance is displayed in gadgets that you can add and remove depending on your requirement.

The following gadgets are available on the Home page by default.

- **System Resources:** Displays the total number of CPU cores, total number of SSL chips, number of free SSL chips, total memory, and free memory on the appliance.

System CPU	Memory Usage (%): Displays the percentage of CPU and memory utilization of the appliance in graphical format.
--------------	---

- **System WAN/LAN Throughput (Mbps):** Displays the total throughput of the SDX appliance for incoming and outgoing traffic in a graph that is plotted in real time and updated at regular intervals.
- **Citrix ADC instances:** Displays the properties of the Citrix ADC instances. The properties displayed are Name, VM State, Instance State, IP Address, Rx (Mbps), Tx (Mbps), HTTP Req/s, and CPU Usage (%) and Memory Usage (%).
Note: On the first logon, the Home page does not display any data related to the Citrix ADC instances because you have not provisioned any instances on your appliance.
- **Health Monitoring Events:** Displays the last 25 events, with their severity, message, and the date and time that the event occurred.

You can do the following on the Home page:

- View and hide Citrix ADC instance details

You can view and hide the details of a particular Citrix ADC instance by clicking the name of the instance in the Name column.

You can also click Expand All to expand all the instance nodes and Collapse All to collapse all the instance nodes.

- Add and remove gadgets

You can also add gadgets to view other system information.

To add these gadgets, click the arrow («) button at the top right corner of the Home page, enter keywords in the search box, and then click Go. The allowed characters are: a-z, A-Z, 0–9, ^, \$, *, and _. Click Go without typing any characters in the search box to display all the gadgets that are available. After the gadget is displayed, click Add to dashboard.

Currently, you can add the following gadgets to the Home page:

- **Hypervisor Details:** The Hypervisor Details gadget displays details about Citrix Hypervisor uptime, edition, version, iSCSI Qualified Name (IQN), product code, serial number, build date, and build number.

- **Licenses:** The Licenses gadget displays the following details: the SDX hardware platform, the maximum number of instances supported on the platform, the maximum supported throughput in Mbps, and the available throughput in Mbps.

If you remove a gadget that is available on the Home page by default, you can add them back to the Home page by searching for the gadget.

Ports

The following ports must be open on the SDX appliance for it to function properly.

Type	Port	Details
TCP	80	Used for incoming HTTP (GUI and NITRO) requests. One of the primary interfaces to access the SDX Management Service interface.
TCP	443	Used for incoming secured HTTP (GUI and NITRO) requests. One of the primary interfaces to access the SDX Management Service interface.
TCP	22	Used for SSH and SCP access to the SDX Management Service interface.
UDP	162	The SDX Management Service interface listens for SNMP traps from the Citrix ADC instances hosted on the SDX appliance.
UDP	161	The SDX Management Service interface listens for SNMP walks/get requests.

Data governance

September 27, 2025

What is a Citrix® ADM service connect?

Citrix Application Delivery Management (ADM) service connect is a feature to enable seamless onboarding of NetScaler SDX appliances and Citrix Gateway appliances onto Citrix ADM service. This feature lets the NetScaler SDX appliance automatically, securely connect with the Citrix ADM service and send system, usage and telemetry data to it. Based on this data, you get insights and recommendations for your Citrix ADC infrastructure on Citrix ADM service.

By using the Citrix ADM service connect feature and onboarding your NetScaler SDX appliances to Citrix ADM service, you can manage all your Citrix ADC and Citrix Gateway assets whether on-premises or in the cloud. In addition, you benefit from access to a rich set of visibility features that help in quick identification of performance issues, high resource usage, critical errors, and so on. Citrix ADM service provides a wide range of capabilities for your Citrix ADC instances and applications. For more information on Citrix ADM service, see [Citrix Application Delivery Management Service](#)

Important

- This document pertains to NetScaler SDX instances. For more information on Citrix ADC appliance, see [Introduction to Citrix ADM service connect for Citrix ADC appliances](#).
- Citrix Gateway also supports the Citrix ADM service connect feature. For better ease, the Citrix Gateway appliance is not called explicitly in the consecutive sections.

Note:

Citrix ADM service connect feature has been released for Citrix ADC instances, and Citrix Gateway instances. However, the corresponding functionality on the Citrix ADM service is available in the upcoming release. The value of this feature will be unleashed soon with the Citrix ADM service release. Citrix updates this note when it happens.

The benefits of this new capability can be used once released on Citrix ADM service.

What is Citrix ADM service?

Citrix ADM service is a cloud-based solution that helps you manage, monitor, orchestrate, automate, and troubleshoot your NetScaler SDX instances by providing you analytical insights and curated machine learning based recommendations about NetScaler SDX instances and about application health, performance, and security. For more information, see [Citrix ADM service Overview](#)

How the Citrix ADM service connect is enabled?

Citrix ADM service connect is enabled by default, after you install or upgrade NetScaler SDX to release 12.1 build 58.xx.

What data is captured using Citrix ADM service connect?

The following details are captured using Citrix ADM service connect:

- **NetScaler SDX details**
 - Management IP address
 - Platform description
 - Platform type
 - Host name
 - Sysid
 - Encoded serial ID
 - Version
 - Serial ID
 - Host ID
 - Type
 - Build type
- **Key usage metrics**
 - Management CPU percentage
 - Memory usage percentage
 - CPU usage percentage
 - System uptime
 - System date time

How the data is used?

By collecting the data, Citrix can provide timely and in-depth insights about your NetScaler SDX installations, which include the following:

- **Key metrics.** Details of key metrics pertaining to CPU, memory, throughput, SSL throughput, and highlight anomalous behavior on NetScaler SDX instances.
- **Critical errors.** Any critical errors that might have occurred on your Citrix ADC instances.
- **Deployment advisory.** Identify Citrix ADC instances that are deployed in standalone mode but have high throughput and are vulnerable to a single point of failure.

How long the collected data is retained?

Any Data collected is retained for no longer than 13 months.

If you decide to terminate the use of the service by disabling the Citrix ADM service connect feature from the Citrix ADC, any previously collected data is deleted after a period of 30 days.

Where the data is stored and how secure is it?

All data collected by Citrix ADM service connect is stored in one of the three regions—United States, European Union, and Australia and New Zealand (ANZ). For more information, see [Geographical Considerations](#).

The data is stored securely with strict tenant isolation at the database layer.

How to disable Citrix ADM service connect?

If you want to disable data collection through Citrix ADM service connect, see [How to enable and disable Citrix ADM service connect](#).

Introduction to Citrix ADM service connect for NetScaler SDX appliances

September 27, 2025

Citrix ADM service is a cloud-based solution that helps you manage, monitor, orchestrate, automate, and troubleshoot your NetScaler SDX appliances. It also provides analytical insights and curated machine learning based recommendations for your applications health, performance, and security. For more information, see [Citrix ADM service](#).

Citrix Application Delivery Management (ADM) service connect is a feature to enable seamless onboarding of NetScaler SDX appliances onto Citrix ADM service. This feature helps NetScaler SDX appliances and Citrix ADM service to function as a holistic solution, which offers customers multi fold benefits.

Citrix ADM service connect feature lets the NetScaler SDX instance automatically connect with Citrix ADM service and send system, usage, and telemetry data to it. Using this data, the Citrix ADM service gives you some insights and recommendations on your NetScaler SDX infrastructure - like quick identification of performance issues, and high resource usage.

To harness the power of Citrix ADM service, you can choose to onboard your NetScaler SDX appliances to Citrix ADM service. The onboarding process uses ADM service connect, and makes the experience seamless and faster for you.

Points to note

- Citrix ADM service connect is now available on NetScaler MPX, SDX, and VPX instances, and Citrix Gateway appliances.
- The corresponding functionality on the Citrix® ADM service is yet to go live. The value of

this feature will be unleashed soon with the Citrix ADM service release, and Citrix update the documentation when it happens.

For more information, see [Data governance](#).

How does Citrix ADM service connect support with Citrix ADM service?

Here is a high-level workflow of how the Citrix ADM service connect feature on Citrix ADC interacts with Citrix ADM service.

1. Citrix ADM service connect feature on NetScaler SDX appliance auto connects with Citrix ADM service using a periodic probe request.
2. This request has system, usage and telemetry data, using which the Citrix ADM service gives you some insights and recommendations on your Citrix ADC infrastructure - like quick identification of performance issues, and high resource usage.
3. You can view the insights and recommendations and decide to onboard your NetScaler SDX appliances to the Citrix ADM service to start managing your NetScaler SDX appliances.
4. When you decide to onboard, the Citrix ADM service connect feature helps complete the onboarding seamlessly.

What versions of Citrix ADC is Citrix ADM service connect supported on?

Citrix ADM service connect is supported on all Citrix ADC platforms and all appliance models (MPX, VPX, and SDX). Starting from Citrix ADC release 12.1 build 58.xx, Citrix ADM service connect is enabled by default for NetScaler SDX appliances.

How to enable Citrix ADM service connect?

If you are an existing Citrix ADC customer, and upgrade to Citrix ADC release 12.1 build 58.x, Citrix ADM service connect is enabled by default as part of the upgrade process.

If you are a new Citrix ADC customer, installing Citrix ADC release 12.1 build 58.x, Citrix ADM service connect is enabled by default as part of the install process.

Note

Unlike the new Citrix ADC appliances, existing NetScaler SDX appliances find the route through Citrix Insight Service (CIS) or Call Home.

How to enable and disable Citrix ADM service connect?

You can enable and disable Citrix ADM service connect from CLI, GUI, or NITRO API methods.

Using the CLI

To enable the Citrix ADM service connect by using the CLI

At the command prompt, type:

```
1 set autoreg_setting autoreg=true
```

To disable the Citrix ADM service connect by using the CLI

At the command prompt, type:

```
1 set autoreg_setting autoreg=false
```

To display Citrix ADM service connect settings by using the CLI

```
1 show autoreg_setting
2
3             autoreg: true
4
5     is_banner_displayed: true
6
7 Done
```

Using the GUI

To disable the Citrix ADM service connect by using the Citrix ADC GUI

1. Navigate to **System**. On the **System** page, click **Configure Citrix ADM service connect** under **System Settings** section.
2. On the **Configure ADM Parameters** page, clear the **Enable Citrix ADM service connect** dialog box, and click **OK**.



Using the NITRO API

You can disable Citrix ADM service connect by using the NITRO command.

```
1 curl -X PUT -H "Content-Type:application/json" http://192.0.2.10/nitro/  
    v1/config/sdx_autoreg -d '{  
2   "sdx_autoreg":{  
3   "autoreg":"false" }  
4   }  
5   ' -u nsroot:Test@1
```

Citrix ADM built-in agent behavior

From Citrix ADC release 12.1 build 58.xx and higher, NetScaler SDX instances have built in agent with ADM service connect functionality. The Citrix ADM built-in agent available on NetScaler SDX instances starts like an active daemon and communicates with ADM service. After communication with ADM service is established, the built-in agent auto-upgrades itself to the latest software version regularly.

References

For more information on Citrix ADM service connect, see the following topics:

- Data governance: [Data governance](#).
- Citrix ADM service: [Citrix Application Delivery Management Service](#).

Single bundle upgrade

September 27, 2025

Note

The Citrix ADM service connect is enabled by default, after you install or upgrade the NetScaler SDX appliance to release 12.1 build 58.xx and above. For more details, see [Data governance](#) and [Citrix ADM service connect](#).

For 10.5 and previous releases, SDX appliance setup includes setting up the Citrix Hypervisor hypervisor, its supplemental packs and hotfixes, the Management Service, Citrix ADC virtual machines, and LOM firmware. Each of these components has a different release cycle. Therefore, updating each component independently, as allowed by SDX 10.5 and earlier releases, makes maintenance difficult. Updating each component separately also leads to unsupported combinations of components.

The single bundle image (SBI) upgrade, available from 11.0 and later releases, combines all the components except the NetScaler VPX instance image and the LOM firmware in a single image file, called the SDX image.

Note

From release 12.0 build 57.19, lights out management (LOM) firmware is added to the SBI, and Citrix customers don't have to upgrade the LOM separately. The LOM firmware is not written by Citrix.

Using this image, you can upgrade all the components in a single step, eliminating the chances of incompatibility between various components. SBI upgrade also ensures that your appliance is always running a version that Citrix® has tested and supports. Because all the SDX components are combined in a single file, the SDX image file is larger than the Management Service image file.

The file name of the image is of the format `build-sdx-12.1-<build_number>.tgz`. After the Management Service is upgraded to SDX 12.1 the new GUI does not display the options to upload the Citrix Hypervisor image file, supplemental packs, or hotfixes. The reason is because SDX 12.1 does not support upgrading individual components.

Points to note

- The SBI upgrade is a multi-step process that might take up to 90 mins.
- First, the Management Service is upgraded to the newer, provided version. During the upgrade, connectivity to the Management Service might be lost. Reconnect to the Management Service to monitor the status of the upgrade.
- Next, the new Management Service upgrades the Citrix Hypervisor and completes the remainder of the appliance upgrade. Management Service from release 11.0 and later is capable of performing a full Citrix Hypervisor upgrade.
- Do not restart the appliance during the Citrix Hypervisor™ upgrade.
- Citrix recommends that you use a Citrix Hypervisor serial console (or LOM console) to monitor the Citrix Hypervisor upgrade.
- 12.1 51.16/19 is not recommended for SBI upgrade. Because after you upgrade the SDX appliance to release 12.1 build 51.16/19, channel configuration on the SDX ADC instances might be lost. As a result, the member interfaces of the channel flap. The workaround is to upgrade the SDX appliance to the latest build (12.1 Build 52.15).

Upgrade the entire appliance to 12.1

If you are currently running version 10.5.66.x or later of the SDX Management Service, you can use the SDX 12.1 image file to upgrade the appliance. If your Management Service is running an older version, you must first upgrade it to version 10.5.66.x or later.

Note: The upgrade process reboots the entire SDX appliance, including all VPX instances, multiple times. Before performing this procedure, if the VPX instances are in an HA setup, fail over all primary HA nodes to the secondary node. If you do not have an HA deployment, plan for the downtime accordingly.

To upgrade the appliance:

1. Upload the SBI file, navigate to **Configuration > Management Service > Software Images**, and then click **Upload**.
2. Navigate to **Configuration > System > System Administration**. Go to **step 3** if you're upgrading from release 10.55 66.x and later. Go to **step 4**, if you're upgrading from release 11.0.
3. In the System Administration group, click **Upgrade Management Service**.
4. In the System Administration group, click **Upgrade Appliance**.
The upgrade process takes a few minutes.

Before the upgrade, the Management Service displays the following information:

- SBI file name
- The current version of SDX running on your appliance
- The selected version to which the appliance is upgraded
- Approximate time to upgrade the appliance
- Miscellaneous information

Before clicking **Upgrade Appliance**, make sure that you have reviewed all the information displayed on the screen. You cannot abort the upgrade process once it starts.

Supported upgrade paths

	11.1	12.0	12.1	13.0	13.1	14.1
10.5 or 11.0	Y	Y	Y	N*	N*	N*
11.1–65.x and later	NA	Not recommended	12.1-56.x and later	Y	Y	Y
12.1	NA	NA	Not recommended	Y	Y	Y

*From 10.5, 11.0, and 11.1 older builds, you must first upgrade to release 11.1 or 12.1, and then upgrade to release 13.0, 13.1, or 14.1.

Related information

[NetScaler SDX hardware-software compatibility matrix](#)

Upgrading a Citrix® ADC instance

September 27, 2025

Note

The Citrix ADM service connect is enabled by default, after you install or upgrade the NetScaler SDX appliance to release 12.1 build 58.xx and above. For more details, see [Data governance](#) and [Citrix ADM service connect](#).

The process of upgrading the Citrix ADC instances involves uploading the build file, and then upgrading the Citrix ADC instance.

Important

Downgrading an ADC instance using the Management Service is not supported. Use the instance CLI to downgrade.

Upload the Citrix ADC software images to the NetScaler SDX appliance before upgrading the Citrix ADC instances. For installing a new instance, you need the Citrix ADC XVA file.

In the Software Images pane, you can view the following details.

- **Name**

Name of the Citrix ADC instance software image file. The file name contains the release and builds number. For example, the file name build-10-53.5_nc.tgz refers to release 10 build 53.5.

- **Last Modified**

Date when the file was last modified.

- **Size**

Size, in MB, of the file.

To Upload a Software Image

1. In the navigation pane, expand Citrix ADC, and then click **Software Images**.
2. In the Software Images pane, click **Upload**.
3. In the **Upload Citrix ADC Software Image** dialog box, click **Browse** and select the Citrix ADC image file that you want to upload.
4. Click **Upload**. The image file appears in the Citrix ADC Software Images pane.

To Create a Backup by Downloading a Build File

1. In the Software Images pane, select the file you want to download, and then click **Download**.
2. In the message box, from the **Save** list, select **Save as**.
3. In the Save As message box, browse to the location where you want to save the file, and then click **Save**.

To Upload an XVA File

1. In the navigation pane, expand Citrix ADC, and then click **Software Images**.
2. In the Software Images pane, on the **XVA Files** tab, click **Upload**.
3. In the **Upload Citrix ADC XVA File** dialog box, click **Browse** and select the Citrix ADC XVA file you want to upload.
4. Click **Upload**. The XVA file appears in the **XVA Files** pane.

To Create a Backup by Downloading an XVA File

1. In the XVA Files pane, select the file you want to download, and then click **Download**.
2. In the message box, from the Save list, select **Save as**.
3. In the **Save As** message box, browse to the location where you want to save the file, and then click **Save**.

Upgrading NetScaler VPX Instances

You can use the Management Service to upgrade one or more of the VPX instances running on the appliance. Before upgrading an instance, make sure that you have uploaded the correct build to the SDX appliance.

Before you start upgrading any instance, ensure that you understand the licensing framework and types of licenses. A software edition upgrade might require new licenses, such as upgrading from the standard edition to the enterprise edition, the standard edition to the platinum edition, or the enterprise edition to the platinum edition. Also note the following:

- To prevent any loss of configuration, save the configuration on each instance before you upgrade any instances.
- You can also upgrade an individual instance from the Instances node. To do so, select the instance from the Instances node. In the details pane, select the instance, and then in the Actions drop down menu, click Upgrade.

- If you have configured a channel from the Citrix ADC instance and want to upgrade the instance from Citrix ADC release 10 to release 10.1 or later, you must delete all the channels from the Citrix ADC instance, upgrade the instance, and then create LACP channels from the Management Service. If you are downgrading the Citrix ADC instance from release 10.1 to release 10.0, you must delete all the LACP channels from the Management Service, downgrade the instance, and then create the LACP channels from the VPX instance.

- **Important**

If you use the SDX Management Service and not the VPX GUI to upgrade VPX instances, the upgrade images are part of the backup file and allow you to restore the instance smoothly.

To Upgrade VPX Instances

1. On the **Configuration** tab, in the navigation pane, click **Citrix ADC**.
2. In the details pane, under **Citrix ADC Configuration**, click **Upgrade**.
3. In the **Upgrade Citrix ADC** dialog box, in **Software Image**, select the Citrix ADC upgrade build file of the version to which you want to upgrade.
4. From the **Instance IP Address** drop-down list, select the IP addresses of the instances that you want to upgrade.
5. Click **OK**, and then click **Close**.

Manage and Monitor the SDX appliance

September 27, 2025

After your NetScaler SDX appliance is up and running, you can perform various tasks to manage and monitor the appliance from the Management Service user interface.

To modify the network configuration of the SDX appliance, click **System**. In the **System** pane, under the Setup Appliance group, click **Network Configuration** and enter the details in the wizard.

Modify the network configuration of the SDX appliance

You can modify the network configuration details that you provided for the SDX appliance during initial configuration.

To modify the network configuration of the SDX appliance, click **System**. In the **System** pane, under the **Setup Appliance** group, click **Network Configuration** and enter the details in the wizard.

Change the password of the default user account

The default user account provides complete access to all features of the NetScaler SDX appliance. To preserve security, use the default admin account only when necessary. Only individuals whose duties require full access must know the password for the default admin account. Citrix recommends changing the default admin password frequently. If you lose the password, you can reset the password to the default by reverting the appliance settings to factory defaults, and you can then change the password.

To change the password of the default user account, click **System > User Administration > Users**. Select a user and click **Edit** to change the password.

Modify the time zone on the appliance

You can modify the time zone of the Management Service and the Citrix Hypervisor. The default time zone is UTC.

To modify the time zone, click **System** and in the **System Settings** group, click **Change Time Zone**.

Modify the host name of the appliance

You can change the host name of the Management Service.

VLAN filtering

VLAN filtering provides segregation of data between VPX instances that share a physical port. For example, if you have configured two VPX instances on two different VLANs and you enable VLAN filtering, one instance cannot view the other instance's traffic. If VLAN filtering is disabled, all the instances can see the tagged or untagged broadcast packets, but the packets are dropped at the software level. If VLAN filtering is enabled, each tagged broadcast packet reaches only the instance that belongs to the corresponding tagged VLAN. If none of the instances belong to the corresponding tagged VLAN, the packet is dropped at the hardware level (NIC).

If VLAN filtering is enabled on an interface, a limited number of tagged VLANs can be used on that interface. 63 tagged VLANs on a 10G interface and 32 tagged VLANs on a 1G interface. A VPX instance receives only the packets that have the configured VLAN IDs. Restart the VPX instances associated with an interface if you change the state of the VLAN filter from DISABLED to ENABLED on that interface.

VLAN filtering is enabled by default on the SDX appliance. If you disable VLAN filtering on an interface, you can configure up to 4096 VLANs on that interface.

Note: VLAN filtering can be disabled only on an SDX appliance running Citrix Hypervisor version 6.0.

To enable VLAN filtering on an interface, click **System > Interfaces**. Select an interface and click **VLAN Filter** and enter the details to enable VLAN filtering.

Configure clock synchronization

When you enable Network Time Protocol (NTP) sync, the Management Service is restarted. You can configure your SDX appliance to synchronize its local clock with an NTP server. As a result, the clock on the SDX appliance has the same date and time settings as the other servers on your network. The clock synchronization configuration does not change if the appliance is restarted, upgraded, or downgraded. However, the configuration does not get propagated to the secondary Citrix® ADC instance in a high availability setup.

The clock is synchronized immediately if you add an NTP server or change any of the authentication parameters. You can also explicitly enable and disable NTP synchronization.

Note: If you do not have a local NTP server, you can find a list of public, open access, NTP servers at the official NTP site,

<http://www.ntp.org>. Before configuring your Citrix ADC to use a public NTP server, be sure to read the Rules of Engagement page (link included on all Public Time Servers pages).

To configure an NTP server, click **System > NTP Servers**.

To enable NTP synchronization

1. In the navigation pane, expand **System**, and then click **NTP Servers**.
2. In the details pane, click **NTP Synchronization**.
3. In the **NTP Synchronization** dialog box, select **Enable NTP Sync**.
4. Click **OK**, and then click **Close**.

To modify authentication options

1. In the navigation pane, expand **System**, and then click **NTP Servers**.
2. In the details pane, click **Authentication Parameters**.
3. In the **Modify Authentication Options** dialog box, set the following parameters:
 - **Authentication**—Enable NTP authentication. Possible values: YES, NO. Default: YES.
 - **Trusted Key IDs**—The trusted key IDs. While adding an NTP server, you select a key identifier from this list. Minimum value: 1. Maximum value: 65534.
 - **Revoke Interval**—The interval between rerandomization of certain cryptographic values used by the Autokey scheme, as a power of 2, in seconds. Default value: 17 (2¹⁷=36 hours).
 - **Automax Interval**—The interval between regeneration of the session key list used with the Autokey protocol, as a power of 2, in seconds. Default value: 12 (2¹²=1.1 hours).

4. Click **OK**, and then click **Close**.

View the properties of the SDX appliance

View system properties such as the number of CPU cores and SSL chips, total available memory and free memory, and various product details on the **Configuration** tab.

To view the properties of the SDX appliance, click the **Configuration** tab.

You can view the following information about system resources, Hypervisor, License, and System:

System Resources:

- **Total CPU Cores:** The number of CPU cores on the SDX appliance.
- **Total SSL Chips:** The total number of SSL chips on the SDX appliance.
- **Free SSL chips:** The total number of SSL chips that have not been assigned to an instance.
- **Total Memory (GB):** Total appliance memory in GB.
- **Free Memory (GB):** Free appliance memory in GB.

Hypervisor Information:

- **Uptime:** Time since the appliance was last restarted, in number of days, hours, and minutes.
- **Edition:** The edition of the Citrix Hypervisor that is installed on the SDX appliance.
- **Version:** The version of the Citrix Hypervisor that is installed on the SDX appliance.
- **iSCSI IQN:** The iSCSI Qualified Name.
- **Product Code:** Product code of Citrix Hypervisor.
- **Serial Number:** Serial number of Citrix Hypervisor.
- **Build Date:** Build date of Citrix Hypervisor.
- **Build Number:** Build number of Citrix Hypervisor.
- **Supplemental Pack:** Version of the supplemental pack installed on the SDX appliance.

License Information:

- **Platform:** Model number of the hardware platform, based on the installed license.
- **Maximum Instances:** The maximum number of instances that you can set up on the SDX appliance, based on the installed license.
- **Available Instances (Shared):** The number of instances that can be configured depending on the number of CPU cores that are still available.

- **Maximum Throughput (Mbps):** The maximum throughput that can be achieved on the appliance, based on the installed license.
- **Available Throughput (Mbps):** The available throughput based on the installed license.

System Information:

- **Platform:** Model number of the hardware platform.
- **Product:** Type of NetScaler® product.
- **Build:** NetScaler release and build running on the SDX appliance.
- **IP Address:** IP address of the Management Service.
- **Host ID:** Citrix Hypervisor host ID.
- **System ID:** Citrix Hypervisor system ID.
- **Serial Number:** Citrix Hypervisor serial number.
- **System Time:** System time displayed in Day Month Date Hours:Min:Sec Timezone Year format.
- **Uptime:** Time since the Management Service was last restarted, in the number of days, hours, and minutes.
- **BIOS version:** BIOS version.

View real-time appliance throughput

The total throughput of the SDX appliance for incoming and outgoing traffic is plotted in real time in a graph that is updated at regular intervals. By default, throughputs for both incoming and outgoing traffic are plotted together on the graph.

To view the throughput of the SDX appliance, on the GUI click **Dashboard** and check **System Throughput (Mbps)**.

View real-time CPU and memory usage

You can view a graph of CPU and memory usage of the appliance. The graph is plotted in real time and updated at regular intervals.

To view the CPU and memory usage of the SDX appliance, on the GUI click **Dashboard** and check **Management Service Statistics**.

View CPU usage for all cores

You can view the usage of each CPU core on the SDX appliance.

The **CPU Core Usage** pane displays the following details:

- **Core Number:** The CPU core number on the appliance.
- **Physical CPU:** The physical CPU number of that core.
- **Hyper Threads:** The hyper threads associated with that CPU core.
- **Instances:** The instances that are using that CPU core.
- **Average Core Usage:** The average core usage, expressed as a percentage.

To view the CPU usage for all the cores on the SDX appliance, on the GUI click **Dashboard** and check **System CPU Usage (%)**.

Install an SSL certificate on the SDX appliance

The SDX appliance is shipped with a default SSL certificate. For security reasons, you might want to replace this certificate with your own SSL certificate. To do so, you must first upload your SSL certificate to the Management Service and then install the certificate. Installing an SSL certificate terminates all current client sessions with the Management Service. Log on to the Management Service for any additional configuration tasks.

To install an SSL certificate, click **System**. In the **Set Up Appliance** group, click **Install SSL Certificate** and enter the details in the wizard.

View the SSL certificate on the Management Service

The Management Service uses an SSL certificate for secure client connections. View the details of this certificate, such as validity status, issuer, subject, days to expire, valid from and to dates, version, and serial number.

To view the SSL certificate, click **System** and in the **Set Up Appliance** group, click **View SSL Certificate**.

SSL certificates and keys for Citrix ADC instances

Separate views of SSL certificates and keys for Citrix ADC instances provide enhanced usability. Use a new Management Service node, SSL Certificate Files, to upload and manage the SSL certificates and corresponding public and private key pairs that can be installed on Citrix ADC instances.

To access the SSL certificates and keys for Citrix ADC instances, navigate to **Configuration > Citrix ADC > SSL Certificate Files**.

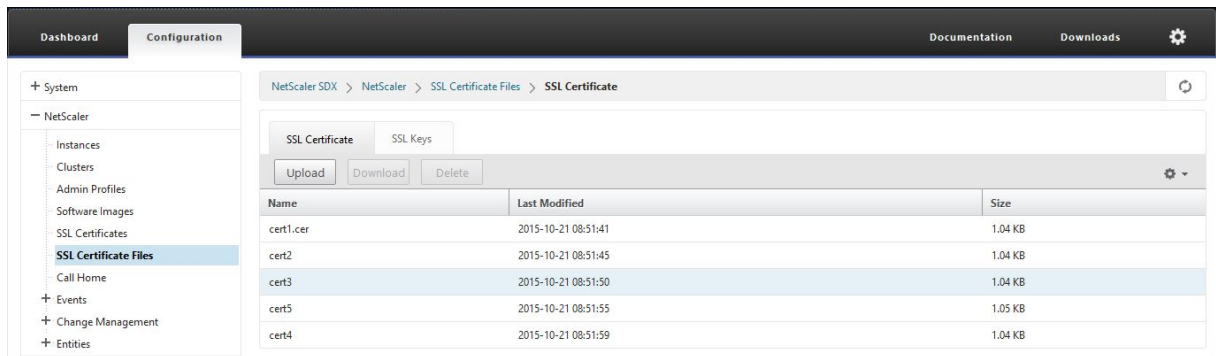

Modify system settings

For security reasons, you can specify that the Management Service and a VPX instance must communicate with each other only over a secure channel. You can also restrict access to the Management Service user interface. Clients can log on the Management Service user interface only by using https.

To modify system settings, click **Configuration > System** and in the System Settings group, click **Change System Settings**.

Restart the appliance

The Management Service provides an option to restart the SDX appliance. During the restart, the appliance shuts down all hosted instances, and then restarts Citrix Hypervisor. When Citrix Hypervisor restarts, it starts all hosted instances along with the Management Service.

To restart the appliance, click **Configuration > System** and in the System Administration group, click **Reboot Appliance**.

Shut down the appliance

You can shut down the SDX appliance from the Management Service.

To shut down the appliance, click **Configuration > System**, and in the System Administration group, click **Shut Down Appliance**.

Creating SDX Administrative Domains

September 27, 2025

SDX administrative domains feature helps you to create multiple administrative domains. You can use the administrative domains to segregate resources for different departments. Administrative domains can therefore improve control over resources, and the resources can be distributed among various domains for optimal use.

A SDX appliance is shipped with fixed resources, such as CPU cores, data throughput, memory, disk space, SSL chips, and a specific number of instances that can be provisioned. The number of instances that you can create depends on the license.

A SDX appliance supports up to three levels of administrative domains. When the appliance is shipped, all the resources are allocated to owner.

Any administrative domains that you create are subdomains of the owner domain. In each case, the subdomain's resources are allocated from the parent domain's pool of resources. The users in an administrative domain have access to that domain's resources. They do not have access to the resources of other domains at the same hierarchical level, nor to the parent-domain resources that have not been specifically allocated to their domain. However, users in a parent domain can access the resources of that domain's subdomains.

Examples of Allocating Resources to Subdomains

Table 1 lists the resources of a root domain named *nsroot* (which is the default name of the root domain). The SDX administrator can allocate these resources to subdomains. In this case, the administrator can allocate a maximum of, for example, 10 CPU cores and 840 GB of disk space.

Table 1. Owner Resources

————— —
CPU core 10
Throughput (Mbps) 18500
Memory (MB) 87300
Disk Space (GB) 840
SSL Chips 36
Instances 36

Table 2 lists the resources allocated a subdomain named *Test*. This subdomain has been allocated 5 of its parent domain's 10 CPU cores, leaving 5 cores that can be allocated to other subdomains of Owner.

Table 2. Test Domain's Resources

CPU core	5
Throughput (Mbps)	1024
Memory (MB)	2048
Disk Space (GB)	40
SSL Chips	8
Instances	4

When creating subdomains, the *Test* domain administrator can allocate only the resources listed in Table 2. The *Test* domain can have only one level of subdomains, because only three levels of domains can be created.

The following figure shows another example of resource allocation among subdomains, using different values from the ones listed in tables 1 and 2.

To create an administrative domain, navigate to Configuration > System > Administrative Domain and select the options that you want. follow the on-screen instructions. Once a new domain is created, log in to the newly created domain by using the Management Service's login page and provide the domain name and user name in the User Name field. For example, if you created a domain named NewDomain with a user NewUser then login as NewDomain\NewUser.

Assigning Users to Domains

When a sub-domain is created, two user groups are automatically created: an admin group and a read-only group. By default, each user is the part of the admin group. A user can be added to multiple groups.

Managing RAID Disk Allocation on 22XXX Series SDX Appliances

September 27, 2025

NetScaler SDX 22040/22060/22080/22100/22120 appliances now include a Redundant Array of Independent Disks (RAID) controller, which can support up to eight physical disks. Multiple disks provide not only performance gains, but also enhanced reliability. Reliability is especially important for a SDX appliance, because the appliance hosts a large number of virtual machines, and a disk failure affects

multiple virtual machines. The RAID controller on the Management Service supports the RAID 1 configuration, which implements disk mirroring. That is, two disks maintain the same data. If a disk in the RAID 1 array fails, its mirror immediately supplies all needed data.

RAID 1 disk mirroring combines two physical drives in one logical drive. The usable capacity of a logical drive is equivalent to the capacity of one of its physical drives. Combining two 1-terabyte drives, for example, creates a single logical drive with a total usable capacity of 1-terabyte. This combination of drives appears to the appliance as a single logical drive.

The SDX appliance is shipped with a configuration that includes logical drive 0, which is allocated for the Management Service and Citrix Hypervisor™, and logical drive 1, which is allocated for Citrix® ADC instances that you will provision. To use additional physical drives, you have to create new logical drives.

Viewing Drive Properties and Operations

A SDX appliance supports a maximum of eight physical-drive slots, that is, a pair of four slots on each side of the appliance. You can insert physical drives into the slots. Before you can use a physical drive, you must make it part of a logical drive needs.

In the Management Service, the Configuration > System > RAID screen includes tabs for logical drives, physical drives, and storage repositories.

Logical Drives

On the Configuration > System > RAID > Logical Drives tab, you can view the name, state, size, of each logical drive, and information about its component physical drives. The following table describes the states of the virtual drive.

State	Description
Optimal	The virtual drive operating condition is good. All configured drives are online.
Degraded	The virtual drive operating condition is not optimal. One of the configured drives has failed or is offline.
Failed	The virtual drive has failed.
Offline	The virtual drive is not available to the RAID controller.

You can also view the details the physical drives associated with the logical drive by selecting the logical drive and clicking **Show Physical Drive**.

To create a new logical drive

1. Navigate to **Configuration > System > RAID**, and select the **Logical Drives** tab.
2. Click **Add**.
3. In the **Create Logical Disk** dialog box, select two slots that contain operational physical drives, and then click **Create**.

Physical Drives

A SDX appliance supports a maximum of eight physical slots, that is, a pair of four slots on each side of the appliance. On the

Configuration >

System >

RAID >

Physical Drives tab, you can view the following information:

- Slot—Physical slot associated with the physical drive.
- Size—Size of the physical drive.
- Firmware State—State of the firmware. Possible Values:
 - Online, spun up—Physical drive is up and is being controlled by RAID.
 - Unconfigured (good)—Physical drive is in good condition and can be added as a part of the logical drive pair.
 - <Unconfigured (bad)—Physical drive is not in good condition and cannot be added as part of a logical drive.
- Foreign State—Indicates if the disk is empty.
- Logical Drive—Associated logical drive.

In the **Physical Drives** pane, you can perform the following actions on the physical drives:

- Initialize—Initialize the disk. You can initialize the physical drive if it is not in good state and needs to be added as a part of logical drive pair.
- Rebuild—Initiate a rebuild of the drive. When a drive in a drive group fails, you can rebuild the drive by re-creating the data that was stored on the drive before it failed. The RAID controller re-creates the data stored on the other drives in the drive group.
- Locate—Locate the drive on the appliance, indicated by causing the Drive Activity LED associated with the drive to blink.
- Stop Locate—Stop locating the drive on the appliance.
- Prepare to Remove—Deactivate the selected physical drive so that it can be removed.

Storage Repository

On the Configuration > System > RAID > **Storage Repository** tab, you can view the status of storage repositories on SDX appliance. You can also view information about a storage-repository drive that is not attached, and you can remove such a drive by selecting the it and then clicking **Remove**. The Storage Repository tab displays the following information about each storage repository:

- Name—Name of the storage repository drive.
- Is Drive Attached—Whether the storage repository is attached or not. If the drive is not attached, you can click **Remove** to delete.
- Size—Size of the storage repository.
- Utilized—Amount of storage-repository space in use.

Adding One Additional Logical Drive to the SDX 22000 Appliance To add an additional logical drive to the SDX 22000 platform:

1. Log on to the Management Service.
2. Navigate to **Configuration > System > RAID**.
3. On the back of the SDX 22000 appliance, insert the two blank SSDs in slot numbers 4 and 5. You can add the SSDs in a running system.
Note: Make sure that the SSDs are Citrix certified.
4. In the Management Service, navigate to **Configuration > System > RAID** and the **Physical Drives** tab. You would see the SSDs that you added.
5. Navigate to the **Logical Drive** tab and click **Add**.
6. In the **Create Logical Disk** page:
 - a) In the **First Slot** drop-down list, select 4.
 - b) In the **Second Slot** drop-down list, select 5.
 - c) Click **Create**.

Note: In Management Service, the slot number begins with zero. So the slot numbering in Management Service differs from the slot numbering on the physical appliance.

The logical drive is created and is listed under the **Logical Drive** tab. Click the refresh icon to update the order of the logical drives.

Adding Second Additional Logical Drive on the SDX 22000 Appliance To add another logical drive, insert the SSDs in slot numbers 6 and 7. In the **Create Logical Disk** page, select 6 from the **First Slot** drop-down list and select 7 from the **Second Slot** drop-down list.

Replacing a Defective SSD Drive with a Blank SSD Drive

To replace a defective SSD drive with a blank SSD drive:

1. Navigate to **Configuration > System > RAID**.
2. On the **Physical Drives** tab, select the defective drive that you want to replace.
3. Click **Prepare to Remove** to remove the drive.
4. Click the refresh icon to refresh the list of physical drives.
5. Physically remove the defective drive from the slot.
6. Insert the new Citrix verified SSD in the slot from where you removed the defective SSD.
7. In the Management Service, navigate to **Configuration > System > RAID**. The new SSD is listed in the **Physical Drives** section. The drive rebuild process starts automatically.

Click the refresh icon to check the status of the rebuild process. When the rebuild process is complete, you can see Online, Spun Up status in the **Firmware State** column.

SDX Licensing Overview

September 27, 2025

In the NetScaler SDX Management Service, you can use your hardware serial number (HSN) or your license access code to allocate your licenses. The Management Service software internally fetches the serial number of your appliance, and Citrix sends the license access code by email when you purchase a license.

Alternatively, if a license is already present on your local computer, you can upload it to the appliance.

For all other functionality, such as returning or reallocating your license, you must use the licensing portal. Optionally, you can still use the licensing portal for license allocation. For more information, see [Manage Licenses on citrix.com](#).

For information about SDX licensing options, see:

- [Choosing the right platform and edition options](#).
- [Licensing models](#)

Note: Installing a perpetual or pooled license doesn't require a reboot of the SDX appliance.

Prerequisites

To use the hardware serial number or license access code to allocate your licenses:

1. You must be able to access public domains through the appliance. For example, the appliance must be able to access www.citrix.com. The license allocation software internally accesses the Citrix licensing portal for your license. To access a public domain, you must configure the Management Service IP address and set up a DNS server.
2. Your license must be linked to your hardware, or you must have a valid license access code.

Allocating your license by using the Management Service

If your license is already linked to your hardware, the license allocation process can use the hardware serial number. Otherwise, you must type the license access code.

You can partially allocate licenses as required for your deployment. For example, if your license file contains 10 licenses, but your current requirement is for only six licenses, you can allocate six licenses now, and allocate more licenses later. You cannot allocate more than the total number of licenses present in your license file.

To allocate your license

1. In a web browser, type the IP address of the Management Service of the SDX appliance (for example, <http://10.102.126.251>).
2. In **User Name** and **Password**, type the administrator credentials.
3. On the **Configuration** tab, navigate to **System > Licenses**.
4. In the details pane, click **Add License File**.

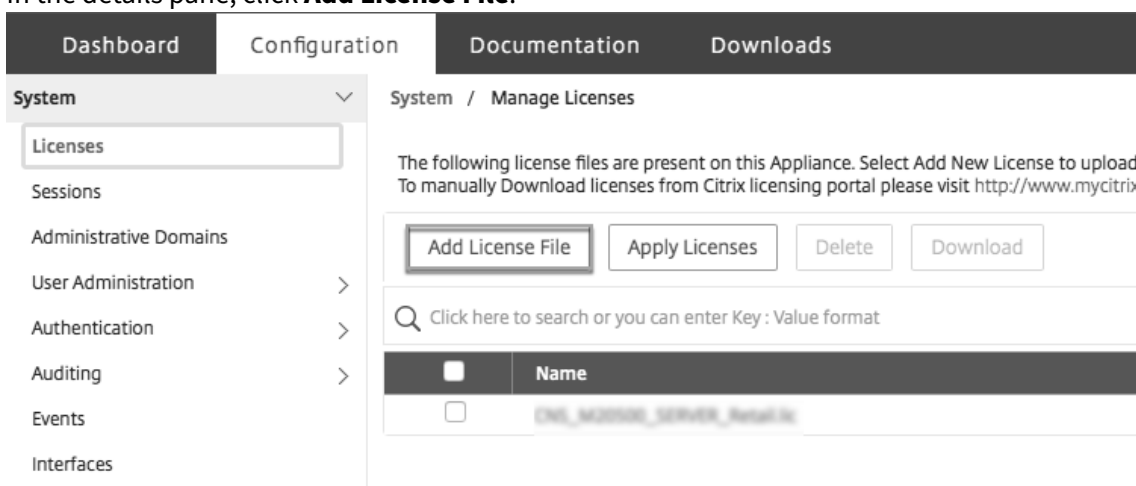

5. Next, select one of the options:
 - Upload license files from a local computer (this option is selected by default)
 - Use license access code

- Use hardware serial number

The screenshot shows the Citrix ADC SDX 12.1 configuration interface. The top navigation bar includes 'Dashboard', 'Configuration', 'Documentation', and 'Downloads'. The left sidebar shows a tree view under 'System' with 'Licenses' selected. The main content area is titled 'Licenses' and contains the following text: 'If a license is already present on your local computer, you can upload it to emailed by Citrix, to allocate licenses from the Citrix licensing portal.' Below this text are three radio button options: 'Upload license files from a local computer' (which is selected), 'Use license access code', and 'Use hardware serial number(22T5N257GU)'. At the bottom of the form are two buttons: 'Browse' and 'Finish'.

- **Use license access code:** If you select this option, either provide the **LAC** in the **License Access Code** field, or select the check box to connect through a proxy server. Next, click **Get Licenses**.
 - Select the license file that you want to use to allocate your licenses.
 - In the **Allocate** column, enter the number of licenses to be allocated. Next, click **Download**.

If the license is downloaded, it appears under **License Files**. Select the license file and click **Apply Licenses**.

- **Use hardware serial number:** If you choose this option, the software internally fetches the serial number of your appliance and uses this number to display your licenses.
 - Click **Get Licenses**, or select the check box for **Connect through Proxy Server** and then click **Get Licenses**.

After you've downloaded the license file, select the license file and click **Apply Licenses**.

Note

The process for returning and modifying Citrix licenses changed as of November 4, 2020. For information about the changes to the “Manage Licenses” portal on citrix.com and “My Licensing Tools” on Partner Central, see <https://support.citrix.com/article/CTX285157>.

SDX Resource Visualizer

September 27, 2025

When a Citrix ADC instance is provisioned on a NetScaler SDX appliance, various resources such as CPU, throughput, memory need to be allocated to an instance. With current SDX, the information about various available resources is not displayed.

Using resource visualizer, all the available resource which can be used to provision an instance are displayed in a single dashboard. All the available and used resources are shown in a graphical format. Resource visualizer also displays other parameters such as power supply status, temperature etc apart from the resources that can be allocated.

The resource visualizer also displays the various resources that an instance is using. To see the various resources associated with an instance, click on the instance name in the visualizer. The right hand side of the visualizer displays all the available and used resources in a graphical format.

The following illustration shows the details captured in resource visualizer:

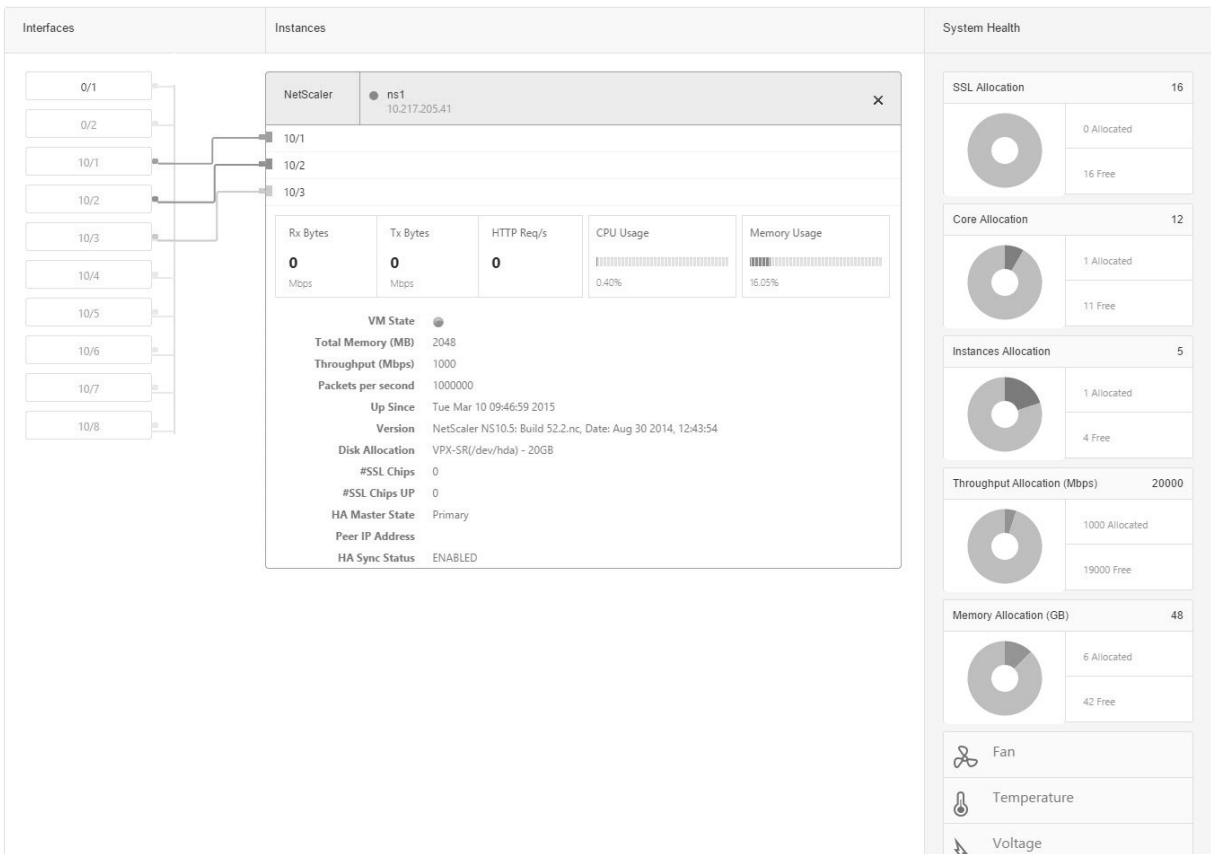

Manage interfaces

September 27, 2025

In the management service's Interfaces pane, you can configure transmission settings for each inter-

face. Also, you can display the mapping of the virtual interfaces on the VPX instances to the SDX appliance, and assign MAC addresses to the interfaces.

Note: Autonegotiation is not supported on an interface to which a direct attach cable (DAC) is connected.

In the list of Interfaces in the **Interfaces** pane, in the **State** column, UP indicates that the interface is receiving traffic normally. DOWN indicates a network issue because of which the interface is unable to send or receive traffic.

Important: Flow control is not recommended from connections over 1 GB.

To configure an interface

1. On the Configuration tab, in the navigation pane, expand System, and then click Interfaces.
 2. In the Interfaces pane, click the interface that you want to configure, and then click Edit.
 3. In the Configure Interface window, specify values for the following parameters:
 - Auto Negotiation*—Enable auto-negotiation. Possible values: ON, OFF. Default: ON.
 - Speed*—Ethernet speed for the interface, in Mb/s. Possible values: 10, 100, 1000, and 10000.
 - Duplex*—Type of duplex operation of the interface. Possible values: Full, Half, NONE. Default: NONE.
 - Flow Control Auto Negotiation*—Automatically negotiate flow control parameters. Possible values: ON, OFF. Default: ON
 - Rx Flow Control*—Enable Rx flow. Possible values: ON, OFF. Default: ON
 - Tx Flow Control*—EnableTx flow control is enabled. Possible values: ON, OFF. Default: ON
- * A required parameter
4. Click OK, and then click Close.

To reset the parameters of an interface to their default values

1. On the Configuration tab, in the navigation pane, expand System, and then click Interfaces.
2. In the Interfaces pane, click the interface that you want to reset, and then click Reset.

Display the mapping of virtual interfaces on the VPX instance to the physical interfaces on the SDX appliance

On a VPX instance, the GUI and the CLI display the mapping of the virtual interfaces on the instance to the physical interfaces on the appliance.

After logging on to the VPX instance, in the configuration utility, navigate to **Network**, and then click **Interfaces**. The virtual interface number on the instance and the corresponding physical interface number on the appliance appear in the **Description** field, as shown in the following figure:

In the CLI, type the show interface command. For example:

```

1 > show interface
2 1) Interface 10/3 (10G VF Interface, PF 10/4) #2
3 flags=0xe460 <ENABLED, UP, UP, HAMON, 802.1q>
4 MTU=1500, native vlan=1, MAC=6e:b6:f5:21:5d:db, uptime 43h03m35s
5 Actual: media FIBER, speed 10000, duplex FULL, fctl NONE, throughput
   10000
6 RX: Pkts(2547925) Bytes(287996153) Errs(0) Drops(527183) Stalls(0)
7 TX: Pkts(196) Bytes(8532) Errs(0) Drops(0) Stalls(0)
8 NIC: InDisc(0) OutDisc(0) Fctls(0) Stalls(0) Hangs(0) Muted(0)
9 Bandwidth thresholds are not set.
10 ...

```

Assign a MAC address to an interface

While provisioning an ADC instance on an SDX appliance, the Citrix Hypervisor™ internally assigns a MAC address to a virtual interface associated with that instance. The same MAC address might be assigned to a virtual interface associated with another instance on the same appliance or on another appliance. To prevent an assignment of duplicate MAC addresses, you can enforce unique MAC addresses.

There are two ways of assigning a MAC address to an interface:

1. Assign a base MAC address and a range to an interface: The Management Service assigns a unique MAC address by using the base address and range.
2. Assign a global base MAC address: A global base MAC address applies to all interfaces. The Management Service then generates the MAC addresses for all interfaces. If you set the global base MAC address, the range for a 1G interface is set to 8 and the range for a 10G interface is set to 64. See the following table for sample base MAC addresses if the global base MAC address is set to 00:00:00:00:00:00.

Physical Interface	Base MAC Address
0/1	00:00:00:00:00:00
0/2	00:00:00:00:00:08
1/1	00:00:00:00:00:10
1/2	00:00:00:00:00:18

Physical Interface	Base MAC Address
1/3	00:00:00:00:00:20
1/4	00:00:00:00:00:28
1/5	00:00:00:00:00:30
1/6	00:00:00:00:00:38
1/7	00:00:00:00:00:40
1/8	00:00:00:00:00:48
10/1	00:00:00:00:00:50
10/2	00:00:00:00:00:90

Table 1. Example of Base MAC Addresses Generated from a Global Base MAC Address

The base MAC address for the management ports is for reference only. The Management Service generates MAC addresses, based on the base MAC address, for 1/x and 10/x ports only.

Note: You cannot assign a base MAC address to a channel.

To perform the various operations with MAC address, click **System > Interfaces**. Select an interface and then click **Edit**. Perform the MAC address operation, in the **Configure Interface** window.

Disable or enable the physical interfaces on the SDX appliance

If you are not using any of the physical interfaces on the SDX appliance, for the security purpose, you can disable the physical interface using the Management Service.

Note: By default, all the physical interfaces on the SDX appliance are enabled. Also, if an interface is used by a VPX or channel, you cannot disable the interface.

To disable the physical interface:

1. On the **Configuration** tab, in the navigation pane, expand **System**, and then click **Interfaces**.
2. In the **Interfaces** pane, select the interface that you want to disable.
3. In the **Action** drop-down list, click **Disable**.

If you want to use the disabled physical interface, you can enable the interface using the Management Service.

To enable the disabled physical interface:

1. On the **Configuration** tab, in the navigation pane, expand **System**, and then click **Interfaces**.
2. In the **Interfaces** pane, select the disable interface that you want to enable.

3. In the **Action** drop-down list, click **Enable**.

Jumbo Frames on SDX Appliances

September 27, 2025

NetScaler SDX appliances support receiving and transmitting jumbo frames containing up to 9216 bytes of IP data. Jumbo frames can transfer large files more efficiently than it is possible with the standard IP MTU size of 1500 bytes.

A NetScaler SDX appliance can use jumbo frames in the following deployment scenarios:

- **Jumbo to Jumbo:** The appliance receives data as jumbo frames and sends it as jumbo frames.
- **Non-Jumbo to Jumbo:** The appliance receives data as non-jumbo frames and sends it as jumbo frames.
- **Jumbo to Non-Jumbo:** The appliance receives data as jumbo frames and sends it as non-jumbo frames.

The Citrix® ADC instances provisioned on SDX appliance support jumbo frames in a load balancing configuration for the following protocols:

- TCP
- Any other protocol over TCP
- SIP

For more information about jumbo frames, see the use cases.

Use Case: Jumbo to Jumbo Setup

Consider an example of a jumbo to jumbo setup in which SIP load balancing virtual server LBVS-1, configured on Citrix ADC instance NS1, is used to load balance SIP traffic across servers S1 and S2. The connection between client CL1 and NS1, and the connection between NS1 and the servers support jumbo frames.

Interface 10/1 of NS1 receives or sends traffic from or to client CL1. Interface 10/2 of NS1 receives or sends traffic from or to server S1 or S2. Interfaces 10/1 and 10/2 of NS1 are part of VLAN 10 and VLAN 20, respectively.

For supporting jumbo frames, the MTU is set to 9216 for interfaces 10/1, 10/2, and VLANs VLAN 10, VLAN 20.

All other network devices, including CL1, S1, S2, in this setup example are also configured for supporting jumbo frames.

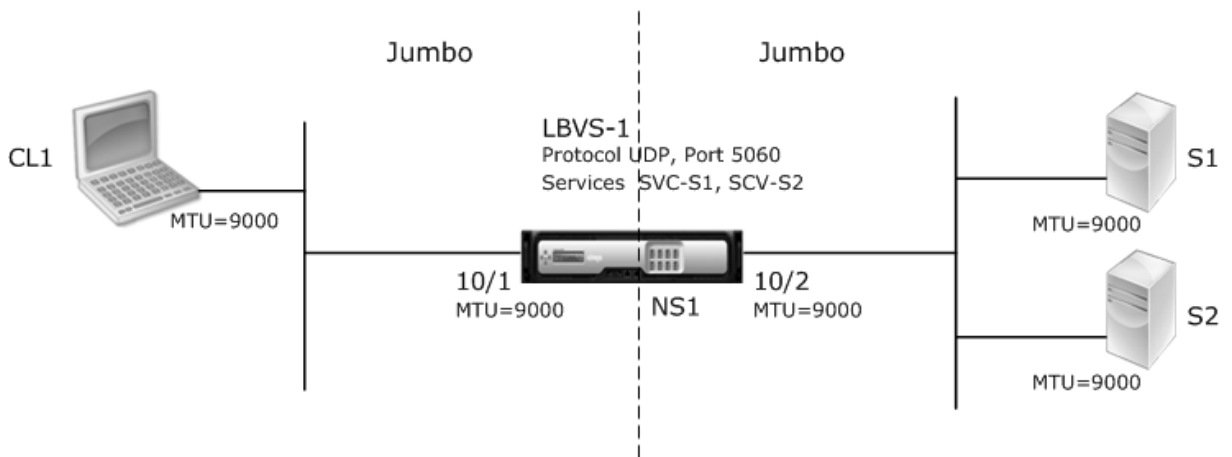

The following table lists the settings used in the example.

Entity	Name	Details
IP address of client CL1	CL1	192.0.2.10
IP address of servers	S1	198.51.100.19
	S2	
MTUs specified for interfaces (by using the Management Service interface) and VLANs on NS1 (by using the CLI).	10/1	9000
		10/2
		VLAN 10
		VLAN 20
Services on NS1 representing servers	SVC-S1	IP address: 198.51.100.19; Protocol: SIP;Port: 5060
Services on NS1 representing servers	SVC-S2	IP address: 198.51.100.20;Protocol: SIP;Port: 5060
Load balancing virtual server on VLAN 10	LBVS-1	IP address: 203.0.113.15;Protocol: SIP;Port: 5060;SVC-S1, SVC-S2

Following is the traffic flow of CL1's request to NS1:

1. CL1 creates a 20000-byte SIP request for LBVS1.

2. CL1 sends the request data in IP fragments to LBVS1 of NS1. The size of each IP fragment is either equal to or less than the MTU (9000) set on the interface from which CL1 sends these fragments to NS1.
 - Size of the first IP fragment = [IP header + UDP header + SIP data segment] = [20 + 8 + 8972] = 9000
 - Size of the second IP fragment = [IP header + SIP data segment] = [20 + 8980] = 9000
 - Size of the last IP fragment = [IP header + SIP data segment] = [20 + 2048] = 2068
3. NS1 receives the request IP fragments at interface 10/1. NS1 accepts these fragments, because the size of each of these fragments is equal to or less than the MTU (9000) of interface 10/1.
4. NS1 reassembles these IP fragments to form the 27000-byte SIP request. NS1 processes this request.
5. LBVS-1's load balancing algorithm selects server S1.
6. NS1 sends the request data in IP fragments to S1. The size of each IP fragment is either equal or less than the MTU (9000) of the interface 10/2, from which NS1 sends these fragments to S1. The IP packets are sourced with a SNIP address of NS1.
 - Size of the first IP fragment = [IP header + UDP header + SIP data segment] = [20 + 8 + 8972] = 9000
 - Size of the second IP fragment = [IP header + SIP data segment] = [20 + 8980] = 9000
 - Size of the last IP fragment = [IP header + SIP data segment] = [20 + 2048] = 2068

Following is the traffic flow of S1's response to CL1 in this example:

1. Server S1 creates a 30000-byte SIP response to send to the SNIP address of NS1.
2. S1 sends the response data in IP fragments to NS1. The size of each IP fragment is either equal to or less than the MTU (9000) set on the interface from which S1 sends these fragments to NS1.
 - Size of the first IP fragment = [IP header + UDP header + SIP data segment] = [20 + 8 + 8972] = 9000
 - Size of the second and third IP fragment = [IP header + SIP data segment] = [20 + 8980] = 9000
 - Size of the last IP fragment = [IP header + SIP data segment] = [20 + 3068] = 3088
3. NS1 receives the response IP fragments at interface 10/2. NS1 accepts these fragments, because the size of each fragment is equal to or less than the MTU (9000) of interface 10/2.
4. NS1 reassembles these IP fragments to form the 27000-byte SIP response. NS1 processes this response.
5. NS1 sends the response data in IP fragments to CL1. The size of each IP fragment is either equal or less than the MTU (9000) of the interface 10/1, from which NS1 sends these fragments to CL1. The IP fragments are sourced with LBVS-1's IP address. These IP packets are sourced from LBVS-1's IP address and destined to CL1's IP address.

- Size of the first IP fragment = [IP header + UDP header + SIP data segment] = [20 + 8 + 8972] = 9000
- Size of the second and third IP fragment = [IP header + SIP data segment] = [20 + 8980] = 9000

Size of the last IP fragment=[IP header + SIP data segment] = [20 + 3068] = 3088

Configuration Tasks:

On the SDX Management Service, navigate to Configuration > System > Interfaces page. Select the required interface and click Edit. Set the MTU value and click OK.

Example:

Set the MTU value for interface 10/1 as 9000 and for interface 10/2 as 9000.

Log on to Citrix ADC instance and use the NetScaler® command line interface to complete the remaining configuration steps.

The following table list the tasks, NetScaler commands, and examples for creating the required configuration on the Citrix ADC instances.

Tasks	NetScaler Command Syntax	Examples
Create VLANs and set the MTU of the desired VLANs for supporting jumbo frames.	add vlan <id> -mtu <positive_integer> show vlan <id>	add vlan 10 -mtu 9000; add vlan 20 -mtu 9000
Bind interfaces to VLANs.	bind vlan <id> -ifnum <interface_name>; show vlan <id>	bind vlan 10 -ifnum 10/1; bind vlan 20 -ifnum 10/2
Add a SNIP address.	add ns ip <IPAddress> <netmask> -type SNIP; show ns ip	add ns ip 198.51.100.18 255.255.255.0 -type SNIP
Create services representing SIP servers.	add service <serviceName> <ip> SIP_UDP <port>; show service <name>	add service SVC-S1 198.51.100.19 SIP_UDP 5060; dd service SVC-S2 198.51.100.20 SIP_UDP 5060
Create SIP load balancing virtual servers and bind the services to it	add lb vserver <name> SIP_UDP <ip> <port>; bind lb vserver <vserverName> <serviceName>; show lb vserver <name>	add lb vserver LBVS-1 SIP_UDP 203.0.113.15 5060; bind lb vserver LBVS-1 SVC-S1; bind lb vserver LBVS-1 SVC-S2
bind lb vserver LBVS-1 SVC-S2	save ns config; show ns config	

Use Case: Non-Jumbo to Jumbo Setup

Consider an example of a non-jumbo to jumbo setup in which load balancing virtual server LBVS1, configured on a Citrix ADC instance NS1, is used to load balance traffic across servers S1 and S2. The connection between client CL1 and NS1 supports non-jumbo frames, and the connection between NS1 and the servers supports jumbo frames.

Interface 10/1 of NS1 receives or sends traffic from or to client CL1. Interface 10/2 of NS1 receives or sends traffic from or to server S1 or S2.

Interfaces 10/1 and 10/2 of NS1 are part of VLAN 10 and VLAN 20, respectively. For supporting only non-jumbo frames between CL1 and NS1, the MTU is set to the default value of 1500 for both interface 10/1 and VLAN 10.

For supporting jumbo frames between NS1 and the servers, the MTU is set to 9000 for interface 10/2 and VLAN 20.

Servers and all other network devices between NS1 and the servers are also configured for supporting jumbo frames. Since HTTP traffic is based on TCP, MSSs are set accordingly at each end point for supporting jumbo frames:

- For the connection between CL1 and virtual server LBVS1 of NS1, the MSS on NS1 is set in a TCP profile, which is then bound to LBVS1.
- For the connection between a SNIP address of NS1 and S1, the MSS on NS1 is set in a TCP profile, which is then bound to the service (SVC-S1) representing S1 on NS1.

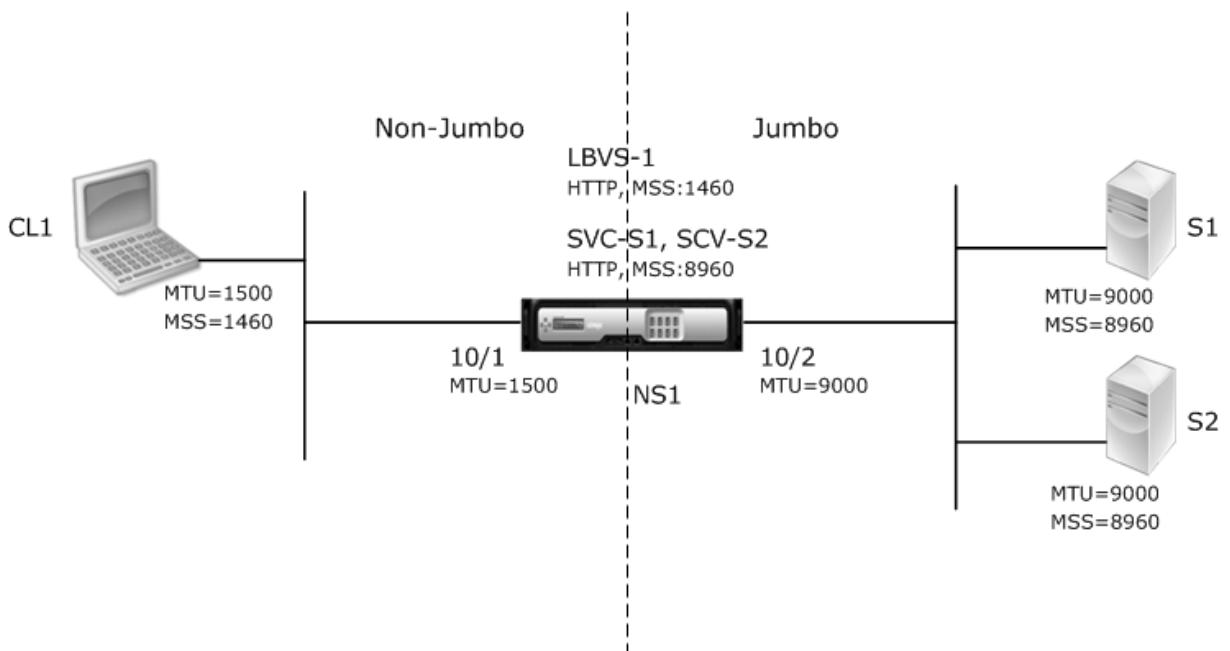

The following table lists the settings used in this example:

Entity	Name	Details
IP address of client CL1	CL1	192.0.2.10
IP address of servers	S1	198.51.100.19
	S2	
MTU for interface 10/1 (by using the Management Service interface).		1500
MTU set for interface 10/2(by using the Management Service interface).		9000
MTU for VLAN 10 on NS1 (by using NetScaler command line interface).		1500
MTU set for VLAN 20 on NS1 (by using NetScaler command line interface).		9000
Services on NS1 representing servers	SVC-S1	IP address: 198.51.100.19; Protocol: HTTP; Port: 80; MSS: 8960
	SVC-S2	
Load balancing virtual server on VLAN 10	LBVS-1	IP address: 203.0.113.15; Protocol: HTTP; Port: 80; Bound services: SVC-S1, SVC-S2; MSS: 1460

Following is the traffic flow of CL1's request to S1 in this example:

1. Client CL1 creates a 200-byte HTTP request to send to virtual server LBVS-1 of NS1.
2. CL1 opens a connection to LBVS-1 of NS1. CL1 and NS1 exchange their respective TCP MSS values while establishing the connection.
3. Because NS1's MSS is larger than the HTTP request, CL1 sends the request data in a single IP packet to NS1.
 - 1.

```

1 <div id="concept_57AEA1C9D3DA47948B6D834341388D29__d978e142">
2
3 Size of the request packet = \[IP Header + TCP Header + TCP
   Request\] = \[20 + 20 + 200\] = 240
4
5 </div>

```

4. NS1 receives the request packet at interface 10/1 and then processes the HTTP request data in the packet.

5. LBVS-1's load balancing algorithm selects server S1, and NS1 opens a connection between one of its SNIP addresses and S1. NS1 and CL1 exchange their respective TCP MSS values while establishing the connection.
6. Because S1's MSS is larger than the HTTP request, NS1 sends the request data in a single IP packet to S1.
 - a) Size of the request packet = [IP Header + TCP Header + [TCP Request]] = [20 + 20 + 200] = 240

Following is the traffic flow of S1's response to CL1 in this example:

1. Server S1 creates an 18000-byte HTTP response to send to the SNIP address of NS1.
2. S1 segments the response data into multiples of NS1's MSS and sends these segments in IP packets to NS1. These IP packets are sourced from S1's IP address and destined to the SNIP address of NS1.
 - Size of the first two packet = [IP Header + TCP Header + (TCP segment=NS1's MSS size)] = [20 + 20 + 8960] = 9000
 - Size of the last packet = [IP Header + TCP Header + (remaining TCP segment)] = [20 + 20 + 2080] = 2120
3. NS1 receives the response packets at interface 10/2.
4. From these IP packets, NS1 assembles all the TCP segments to form the HTTP response data of 18000 bytes. NS1 processes this response.
5. NS1 segments the response data into multiples of CL1's MSS and sends these segments in IP packets, from interface 10/1, to CL1. These IP packets are sourced from LBVS-1's IP address and destined to CL1's IP address.
 - Size of all the packet except the last = [IP Header + TCP Header + (TCP payload=CL1's MSS size)] = [20 + 20 + 1460] = 1500
 - Size of the last packet = [IP Header + TCP Header + (remaining TCP segment)] = [20 + 20 + 480] = 520

Configuration Tasks:

On the SDX Management Service, navigate to Configuration > System > Interfaces page. Select the required interface and click Edit. Set the MTU value and click OK.

Example:

Set the following MTU values:

- For 10/1 interface as 1500
- For 10/2 interface as 9000

Log on to Citrix ADC instance and use the NetScaler command line interface to complete the remaining configuration steps.

The following table list the tasks, NetScaler commands, and examples for creating the required configuration on the Citrix ADC instances.

Tasks	NetScaler Command Line Syntax	Example
Create VLANs and set the MTU of the desired VLANs for supporting jumbo frames.	add vlan <id>	
-mtu <positive_integer>; show vlan <id>	add vlan 10 -mtu 1500; add vlan 20 -mtu 9000	
Bind interfaces to VLANs.	bind vlan <id> -ifnum <interface_name>; show vlan <id>	bind vlan 10 -ifnum 10/1; bind vlan 20 -ifnum 10/2
Add a SNIP address.	add ns ip <IPAddress> <netmask> -type SNIP; show ns ip	add ns ip 198.51.100.18 255.255.255.0 -type SNIP
Create services representing HTTP servers	add service <serviceName> <ip> HTTP <port>; show service <name>	add service SVC-S1 198.51.100.19 http 80; add service SVC-S2 198.51.100.20 http 80
Create HTTP load balancing virtual servers and bind the services to it	add lb vserver <name> HTTP <ip> <port>; bind lb vserver <vserverName> <serviceName>; show lb vserver <name>	add lb vserver LBVS-1 http 203.0.113.15 80; bind lb vserver LBVS-1 SVC-S1
Create a custom TCP profile and set its MSS for supporting jumbo frames.	add tcpProfile <name> -mss <positive_integer>; show tcpProfile <name>	add tcpprofile NS1-SERVERS-JUMBO -mss 8960
Bind the custom TCP profile to the desired services.	set service <Name> -tcpProfileName <string>; show service <name>	set service SVC-S1 -tcpProfileName NS1- SERVERS-JUMBO; set service SVC-S2 -tcpProfileName NS1- SERVERS-JUMBO
Save the configuration	save ns config; show ns config	

Use Case: Coexistence of Jumbo and Non-Jumbo flows on Same Set of Interfaces

Consider an example in which load balancing virtual servers LBVS1 and LBVS2 are configured on Citrix ADC instance NS1. LBVS1 is used to load balance HTTP traffic across servers S1 and S2, and global is used to load balance traffic across servers S3 and S4.

CL1 is on VLAN 10, S1 and S2 are on VLAN20, CL2 is on VLAN 30, and S3 and S4 are on VLAN 40. VLAN 10 and VLAN 20 support jumbo frames, and VLAN 30 and VLAN 40 support only non-jumbo frames.

In other words, the connection between CL1 and NS1, and the connection between NS1 and server S1 or S2 support jumbo frames. The connection between CL2 and NS1, and the connection between NS1 and server S3 or S4 support only non-jumbo frames.

Interface 10/1 of NS1 receives or sends traffic from or to clients. Interface 10/2 of NS1 receives or sends traffic from or to the servers.

Interface 10/1 is bound to both VLAN 10 and VLAN 20 as a tagged interface, and interface 10/2 is bound to both VLAN 30 and VLAN 40 as a tagged interface.

For supporting jumbo frames, the MTU is set to 9216 for interfaces 10/1 and 10/2.

On NS1, the MTU is set to 9000 for VLAN 10 and VLAN 30 for supporting jumbo frames, and the MTU is set to the default value of 1500 for VLAN 20 and VLAN 40 for supporting only non-jumbo frames.

The effective MTU on a NetScaler interface for VLAN tagged packets is of the MTU of the interface or the MTU of the VLAN, whichever is lower. For example:

- The MTU of interface 10/1 is 9216. The MTU of VLAN 10 is 9000. On interface 10/1, the MTU of VLAN 10 tagged packets is 9000.
- The MTU of interface 10/2 is 9216. The MTU of VLAN 20 is 9000. On interface 10/2, the MTU of VLAN 20 tagged packets is 9000.
- The MTU of interface 10/1 is 9216. The MTU of VLAN 30 is 1500. On interface 10/1, the MTU of VLAN 30 tagged packets is 1500.
- The MTU of interface 10/2 is 9216. The MTU of VLAN 40 is 1500. On interface 10/2, the MTU of VLAN 40 tagged packets is 9000.

CL1, S1, S2, and all network devices between CL1 and S1 or S2 are configured for jumbo frames.

Since HTTP traffic is based on TCP, MSSs are set accordingly at each end point for supporting jumbo frames.

- For the connection between CL1 and virtual server LBVS-1 of NS1, the MSS on NS1 is set in a TCP profile, which is then bound to LBVS1.
- For the connection between a SNIP address of NS1 and S1, the MSS on NS1 is set in a TCP profile, which is then bound to the service (SVC-S1) representing S1 on NS1.

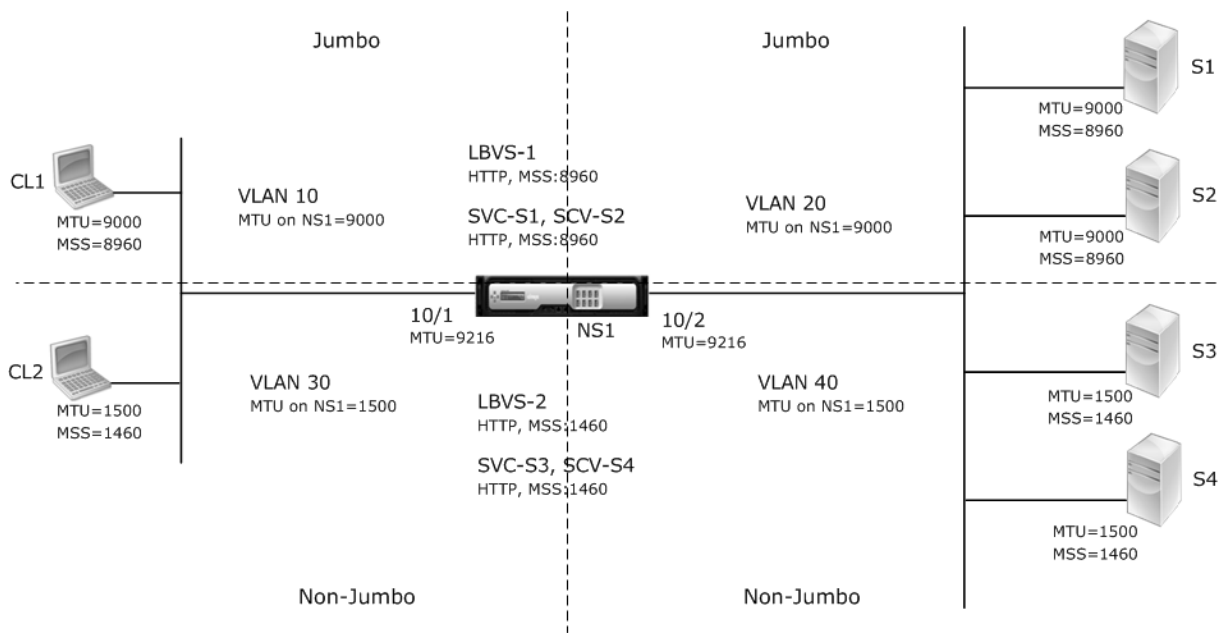

The following table lists the settings used in this example.

Entity	Name	Details
IP address of clients	CL1	192.0.2.10
		CL2
IP address of servers	S1	198.51.100.19
		S2
		S3
		S4
SNIP addresses on NS1		198.51.100.18; 198.51.101.18
MTU specified for interfaces and VLANs on NS1	10/1	9216
		10/2
VLAN 10	9000	
VLAN 20	9000	
VLAN 30	9000	
VLAN 40	1500	
Default TCP profile	nstcp_default_profile	MSS: 1460
Custom TCP profile	ALL-JUMBO	MSS: 8960

Entity	Name	Details
Services on NS1 representing servers	SVC-S1	IP address: 198.51.100.19; Protocol: HTTP; Port: 80; TCP profile: ALL-JUMBO (MSS: 8960)
	SVC-S2	
	SVC-S3	
	SVC-S4	
Load balancing virtual servers on NS1	LBVS-1	IP address = 203.0.113.15; Protocol: HTTP; Port:80; Bound services: SVC-S1, SVC-S2; TCP profile: ALL-JUMBO (MSS: 8960)
	LBVS-2	

Following is the traffic flow of CL1's request to S1:

- Client CL1 creates a 20000-byte HTTP request to send to virtual server LBVS-1 of NS1.
- CL1 opens a connection to LBVS-1 of NS1. CL1 and NS1 exchange their TCP MSS values while establishing the connection.
- Because NS1's MSS value is smaller than the HTTP request, CL1 segments the request data into multiples of NS1's MSS and sends these segments in IP packets tagged as VLAN 10 to NS1.
 - Size of the first two packets = [IP Header + TCP Header + (TCP segment=NS1 MSS)] = [20 + 20 + 8960] = 9000
 - Size of the last packet = [IP Header + TCP Header + (remaining TCP segment)] = [20 + 20 + 2080] = 2120
- NS1 receives these packets at interface 10/1. NS1 accepts these packets because the size of these packets is equal to or less than the effective MTU (9000) of interface 10/1 for VLAN 10 tagged packets.
- From the IP packets, NS1 assembles all the TCP segments to form the 20000-byte HTTP request. NS1 processes this request.
- LBVS-1's load balancing algorithm selects server S1, and NS1 opens a connection between one of its SNIP addresses and S1. NS1 and CL1 exchange their respective TCP MSS values while establishing the connection.
- NS1 segments the request data into multiples of S1's MSS and sends these segments in IP packets tagged as VLAN 20 to S1.
 - Size of the first two packets = [IP Header + TCP Header + (TCP payload=S1 MSS)] = [20 + 20 + 8960] = 9000

- Size of the last packet = [IP Header + TCP Header + (remaining TCP segment)] = [20 + 20 + 2080] = 2120

Following is the traffic flow of S1's response to CL1:

1. Server S1 creates a 30000-byte HTTP response to send to the SNIP address of NS1.
2. S1 segments the response data into multiples of NS1's MSS and sends these segments in IP packets tagged as VLAN 20 to NS1. These IP packets are sourced from S1's IP address and destined to the SNIP address of NS1.

- Size of first three packet = [IP Header + TCP Header + (TCP segment=NS1's MSS size)] = [20 + 20 + 8960] = 9000
- Size of the last packet = [IP Header + TCP Header + (remaining TCP segment)] = [20 + 20 + 3120] = 3160

3. NS1 receives the response packets at interface 10/2. NS1 accepts these packets, because their size is equal to or less than the effective MTU value (9000) of interface 10/2 for VLAN 20 tagged packets.
4. From these IP packets, NS1 assembles all the TCP segments to form the 30000-byte HTTP response. NS1 processes this response.
5. NS1 segments the response data into multiples of CL1's MSS and sends these segments in IP packets tagged as VLAN 10, from interface 10/1, to CL1. These IP packets are sourced from LBVS' s IP address and destined to CL1's IP address.

- Size of first three packet = [IP Header + TCP Header + [(TCP payload=CL1's MSS size)] = [20 + 20 + 8960] = 9000
- Size of the last packet = [IP Header + TCP Header + (remaining TCP segment)] = [20 + 20 + 3120] = 3160

Configuration Tasks:

On the SDX Management Service, navigate to Configuration > System > Interfaces page. Select the required interface and click Edit. Set the MTU value and click OK.

Example:

Set the following MTU values:

- For 10/1 interface as 9216
- For 10/2 interface as 9216

Log on to Citrix ADC instance and use the NetScaler command line interface to complete the remaining configuration steps.

The following table list the tasks, NetScaler commands, and examples for creating the required configuration on the Citrix ADC instances.

Task	Syntax	Example
<p>Create VLANs and set the MTU of the desired VLANs for supporting jumbo frames.</p> <p>Bind interfaces to VLANs.</p>	<pre>add vlan <id> -mtu <positive_integer>; show vlan <id> bind vlan <id> -ifnum <interface_name>; show vlan <id></pre>	<pre>add vlan 10 -mtu 9000; add vlan 20 -mtu 9000; add vlan 30 -mtu 1500; add vlan 40 -mtu 1500 bind vlan 10 -ifnum 10/1 -tagged; bind vlan 20 -ifnum 10/2 -tagged; bind vlan 30 -ifnum 10/1 -tagged; bind vlan 40 -ifnum 10/2 -tagged</pre>
<p>Add a SNIP address.</p>	<pre>add ns ip <IPAddress> <netmask> -type SNIP; show ns ip</pre>	<pre>add ns ip 198.51.100.18 255.255.255.0 -type SNIP; add ns ip 198.51.101.18 255.255.255.0 -type SNIP</pre>
<p>Create services representing HTTP servers.</p>	<pre>add service <serviceName> <ip> HTTP <port>; show service <name></pre>	<pre>add service SVC-S1 198.51.100.19 http 80; add service SVC-S2 198.51.100.20 http 80; add service SVC-S3 198.51.101.19 http 80; add service SVC-S4 198.51.101.20 http 80</pre>
<p>Create HTTP load balancing virtual servers and bind the services to it</p>	<pre>add lb vserver <name> HTTP <ip> <port>; bind lb vserver <vserverName> <serviceName>; show lb vserver <name></pre>	<pre>add lb vserver LBVS-1 http 203.0.113.15 80; bind lb vserver LBVS-1 SVC-S1; bind lb vserver LBVS-1 SVC-S2</pre>
<p>Create a custom TCP profile and set its MSS for supporting jumbo frames.</p> <p>Bind the custom TCP profile to the desired load balancing virtual server and services.</p>	<pre>add tcpProfile <name> -mss <positive_integer>; show tcpProfile <name> set service <Name> -tcpProfileName <string>; show service <name></pre>	<pre>add tcpprofile ALL-JUMBO -mss 8960 set lb vserver LBVS-1 - tcpProfileName ALL-JUMBO; set service SVC-S1 - tcpProfileName ALL-JUMBO; set service SVC-S2 - tcpProfileName ALL-JUMBO</pre>
<p>Save the configuration</p>	<pre>save ns config; show ns config</pre>	

Configuring SNMP on SDX Appliances

September 27, 2025

You can configure a Simple Network Management Protocol (SNMP) agent on the NetScaler SDX appliance to generate asynchronous events, which are called traps. The traps are generated whenever there are abnormal conditions on the SDX appliance. The traps are then sent to a remote device called a *trap listener*, which signals the abnormal condition on the SDX appliance.

In addition to configuring an SNMP trap destination, downloading MIB files, and configuring one or more SNMP managers, you can configure the NetScaler SDX appliance for SNMPv3 queries.

The following figure illustrates a network with a SDX appliance that has SNMP enabled and configured. In the figure, each SNMP network management application uses SNMP to communicate with the SNMP agent on the SDX appliance.

Figure 1. SDX Appliance Supporting SNMP

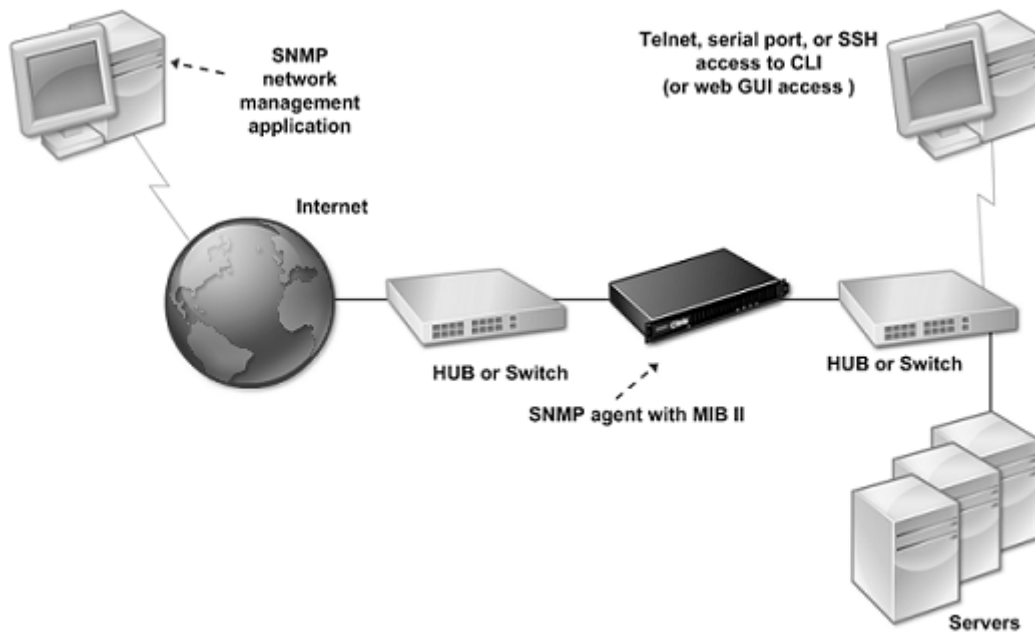

The SNMP agent on the SDX appliance generates traps that are compliant with SNMPv2 only. The supported traps can be viewed in the SDX MIB file. You can download this file from the Downloads page in the SDX user interface.

To add an SNMP trap destination

1. On the configuration tab, in the navigation pane, expand System > SNMP, and then click SNMP Trap Destinations.

2. In the SNMP Trap Destinations pane, click Add.
3. In the Configure SNMP Trap Destination page, specify values for the following parameters:
 - Destination Server—IPv4 address of the trap listener to which to send the SNMP trap messages.
 - Port—UDP port at which the trap listener listens for trap messages. Must match the setting on the trap listener, or the listener drops the messages. Minimum value: 1. Default: 162.
 - Community—Password (string) sent with the trap messages, so that the trap listener can authenticate them. Can include letters, numbers, and hyphen (-), period (.) hash (#), space (), at (@), equals (=), colon (:), and underscore (_) characters.
Note: You must specify the same community string on the trap listener device, or the listener drops the messages. Default: public.
4. Click Add, and then click Close. The SNMP trap destination that you added appears in the SNMP Traps pane.

To modify the values of the parameters of an SNMP trap destination, in the SNMP Trap Destinations pane, select the trap destination that you want to modify, and then click Modify. In the Modify SNMP Trap Destination dialog box, modify the parameters.

To remove an SNMP trap, in the SNMP Trap Destinations pane, select the trap destination that you want to remove, and then click Delete. In the Confirm message box, click to remove the SNMP trap destination.

Downloading MIB Files

You must download the following file before you start monitoring a SDX appliance.

SDX-MIB-smiv2.mib. This file is used by SNMPv2 managers and SNMPv2 trap listeners.

The file includes a Citrix® ADC enterprise MIB that provides SDX-specific events.

To download MIB files

1. Log on to the Downloads page of the SDX appliance user interface.
2. Under SNMP Files, click SNMP v2 - MIB Object Definitions. You can open the file by using a MIB browser.

Adding an SNMP Manager Community

You must configure SNMP managers on the SDX appliance to query and monitor the appliance and managed devices hosted on the appliance. Also, you must provide the SNMP manager with the re-

quired appliance-specific information. For an IPv4 SNMP manager you can specify a host name instead of the manager's IP address. If you do so, you must add a DNS name server that resolves the host name of the SNMP manager to its IP address.

You must configure at least one SNMP manager. If you do not configure an SNMP manager, the appliance does not accept or respond to SNMP queries from any IP address on the network. If you configure one or more SNMP managers, the appliance accepts and responds only to SNMP queries from those specific IP addresses.

To configure an SNMP manager

1. On the Configuration tab, in the navigation pane, expand System, and then expand SNMP.
2. Click Managers.
3. In the details pane, click Add.
4. In the Create SNMP Manager Community page, set the following parameters:
 - **SNMP Manager**—IPv4 address of the SNMP manager. Alternatively, instead of an IPv4 address, you can specify a host name that has been assigned to an SNMP manager. If you do so, you must add a DNS name server that resolves the host name of the SNMP manager to its IP address.
 - **Community**—The SNMP community string. Can consist of 1 to 31 characters that include uppercase and lowercase letters, numbers, and the hyphen (-), period (.) pound (#), at (@), equals (=), colon (:), and underscore (_) characters.
 - Select the **Enable Management Network** checkbox to specify the SNMP managers by using the netmask.
 - In the **Netmask** field, enter the netmask of the SNMP community.
5. Click Add, and then click Close.

Configuring the SDX Appliance for SNMPv3 Queries

Simple Network Management Protocol Version 3 (SNMPv3) is based on the basic structure and architecture of SNMPv1 and SNMPv2. However, SNMPv3 enhances the basic architecture to incorporate administration and security capabilities, such as authentication, access control, data integrity check, data origin verification, message timeliness check, and data confidentiality.

The NetScaler SDX appliance supports the following entities that enable you to implement the security features of SNMPv3:

- SNMP Views
- SNMP Users

These entities function together to implement the SNMPv3 security features. Views are created to allow access to subtrees of the MIB.

Adding an SNMP Manager

You must configure the SDX appliance to allow the appropriate SNMP managers to query it. You must also provide the SNMP manager with the required appliance-specific information. For an IPv4 SNMP manager you can specify a host name instead of the manager's IP address. If you do so, you must add a DNS name server that resolves the host name of the SNMP manager to its IP address.

You must configure at least one SNMP manager. If you do not configure an SNMP manager, the appliance does not accept or respond to SNMP queries from any IP address on the network. If you configure one or more SNMP managers, the appliance accepts and responds only to SNMP queries from those specific IP addresses.

To configure an SNMP manager:

1. Navigate to the System > Configuration page.
2. On the Configuration tab, in the navigation pane, expand System, and then expand SNMP.
3. Click Managers.
4. In the details pane, click Add.
5. In the Add SNMP Manager Community dialog box, set the following parameters:
 - **SNMP Manager**—IPv4 address of the SNMP manager. Alternatively, instead of an IPv4 address, you can specify a host name that has been assigned to an SNMP manager. If you do so, you must add a DNS name server that resolves the host name of the SNMP manager to its IP address.
 - **Community**—The SNMP community string. Can consist of 1 to 31 characters that include uppercase and lowercase letters, numbers, and the hyphen (-), period (.) pound (#), at (@), equals (=), colon (:), and underscore (_) characters.
6. Click Add, and then click Close.

Configuring an SNMP View

SNMP views restrict user access to specific portions of the MIB. SNMP views are used to implement access control.

To configure a view

1. On the Configuration tab, in the navigation pane, expand System, and then expand SNMP.
2. Click Views.

3. In the details pane, click Add.
4. In the Add SNMP View dialog box, set the following parameters:
 - Name—Name for the SNMPv3 view. Can consist of 1 to 31 characters that include uppercase and lowercase letters, numbers, and the hyphen (-), period (.) pound (#), at (@), equals (=), colon (:), and underscore (_) characters. You should choose a name that helps identify the SNMPv3 view.
 - Subtree—A particular branch (subtree) of the MIB tree, which you want to associate with this SNMPv3 view. You must specify the subtree as an SNMP OID.
 - Type—Include or exclude the subtree, specified by the subtree parameter, in or from this view. This setting can be useful when you have included a subtree, such as A, in an SNMPv3 view and you want to exclude a specific subtree of A, such as B, from the SNMPv3 view.

Configuring an SNMP User

After you have created an SNMP view, add SNMP users. SNMP users have access to the MIBs that are required for querying the SNMP managers.

To configure a user

1. On the Configuration tab, in the navigation pane, expand System, and then expand SNMP.
2. Click Users.
3. In the details pane, click Add.
4. In the Create SNMP Userpage, set the following parameters:
 - Name—Name for the SNMPv3 user. Can consist of 1 to 31 characters that include uppercase and lowercase letters, numbers, and the hyphen (-), period (.) pound (#), at (@), equals (=), colon (:), and underscore (_) characters.
 - Security Level—Security level required for communication between the appliance and the SNMPv3 users. Select from one of the following options:
 - noAuthNoPriv—Require neither authentication nor encryption.
 - authNoPriv—Require authentication but no encryption.
 - authPriv—Require authentication and encryption.
 - Authentication Protocol—Authentication algorithm used by the appliance and the SNMPv3 user for authenticating the communication between them. You must specify the same authentication algorithm when you configure the SNMPv3 user in the SNMP manager.
 - Authentication Password—Pass phrase to be used by the authentication algorithm. Can consist of 1 to 31 characters that include uppercase and lowercase letters, numbers, and

the hyphen (-), period (.) pound (#), space (), at (@), equals (=), colon (:), and underscore (_) characters.

- Privacy Protocol—Encryption algorithm used by the appliance and the SNMPv3 user for encrypting the communication between them. You must specify the same encryption algorithm when you configure the SNMPv3 user in the SNMP manager.
- View Name—Name of the configured SNMPv3 view that you want to bind to this SNMPv3 user. An SNMPv3 user can access the subtrees that are bound to this SNMPv3 view as type INCLUDED, but cannot access the ones that are type EXCLUDED.

Configuring an SNMP Alarm

The appliance provides a predefined set of condition entities called SNMP alarms. When the condition set for an SNMP alarm is met, the appliance generates SNMP trap messages that are sent to the configured trap listeners. For example, when the deviceAdded alarm is enabled, a trap message is generated and sent to the trap listener whenever a device (instance) is provisioned on the appliance. You can assign a severity level to an SNMP alarm. When you do so, the corresponding trap messages are assigned that severity level.

Following are the severity levels defined on the appliance, in decreasing order of severity:

- Critical
 - Major
- Minor
- Warning
- Informational (default)

For example, if you set a Warning severity level for the SNMP alarm named deviceAdded, the trap messages generated when a device is added are assigned with the Warning severity level.

You can also configure an SNMP alarm to log the corresponding trap messages generated whenever the condition on that alarm is met.

To modify a predefined SNMP alarm, click System > SNMP > Alarms.

Configuring Syslog Notifications

September 27, 2025

SYSLOG is a standard logging protocol. It has two components: the SYSLOG auditing module, which runs on the NetScaler SDX appliance, and the SYSLOG server, which can run on a remote system. SYSLOG uses user data protocol (UDP) for data transfer.

When you run a SYSLOG server, it connects to the SDX appliance. The appliance then starts sending all the log information to the SYSLOG server, and the server can filter the log entries before storing them in a log file. A SYSLOG server can receive log information from more than one SDX appliance, and an SDX appliance can send log information to more than one SYSLOG server.

The log information that a SYSLOG server collects from an SDX appliance is stored in a log file in the form of messages. These messages typically contain the following information:

- The IP address of the SDX appliance that generated the log message
- A time stamp
- The message type
- The log level (Critical, Error, Notice, Warning, Informational, Debug, Alert, or Emergency)
- The message information

You can use this information to analyze the source of the alert and take corrective action if required. First configure a syslog server that the appliance sends log information to, and then specify the data and time format for recording the log messages.

To configure a Syslog Server

1. Navigate to **System > Notifications > Syslog Servers**.
2. In the details pane, click **Add**.
3. In the **Create Syslog Server** page, specify values for the syslog server parameters. For a description of a parameter, hover the mouse over the corresponding field.
4. Click **Add**, and then click **Close**.

To configure the syslog parameters

1. Navigate to **System > Notifications > Syslog Servers**.
2. In the details pane, click **Syslog Parameters**.
3. In the **Configure Syslog Parameters** page, specify the date and time format.
4. Click **OK**, and then click **Close**.

Configuring Mail Notifications

September 27, 2025

Configure an SMTP server to receive an email message each time an alert is raised. First configure an SMTP server, and then configure a mail profile. In the mail profile, use commas to separate the addresses of the recipients.

To configure an SMTP server

1. Navigate to **System > Notifications > Email**.
2. In the details pane, click the **Email Server** tab, and then click **Add**.
3. In the **Create Email Server** page, specify values for the server parameters.
 - **Server name / IP address:** Enter the server name or IP address of the SMTP mail server.
 - **Port:** Enter the port number. The default value is 25.
 - **Authentication:** Select this option to authenticate access to the email server.
 - **Secure:** Select this option to create a secure email connection. By default, TLS 1.2 is used to encrypt the email communication.
4. Click **Create**.

To configure a mail profile

1. Navigate to **System > Notifications > Email**.
2. In the details pane, click the **Email** tab, and then click **Add**.
3. In the **Create Email Distribution List** page, specify values for the parameters. For a description of a parameter, hover the mouse over the corresponding field.
4. Click **Create**.

Configuring SMS Notifications

September 27, 2025

You must configure a short message service (SMS) server to receive an SMS message each time an alert is raised. First configure an SMS server, and then configure an SMS profile. In the SMS profile, use commas to separate the addresses of the recipients.

To configure an SMS server

1. Navigate to System > Notifications > SMS.
2. In the details pane, click SMS Server, and then click Add.
3. In the Create SMS Server page, specify values for the SMS server parameters. The values for these parameters are provided by the vendor.
4. Click Create, and then click Close.

To configure an SMS profile

1. Navigate to System > Notifications > SMS.
2. In the details pane, click SMS Distribution List, and then click Add.
3. In the Create SMS Distribution List page, specify values for the mail profile parameters. For a description of a parameter, hover the mouse over the corresponding field.
4. Click Create, and then click Close.

Monitoring and Managing the Real-Time Status of Entities Configured on an SDX Appliance

September 27, 2025

The NetScaler SDX appliance can monitor and manage the states of virtual servers, services, service groups, and servers across the virtual appliances hosted on the SDX appliance. You can monitor values, such as the health of a virtual server and the time elapsed since the last state change of a service or service group. This gives you visibility into the real-time status of the entities and makes management of these entities easy when you have a large number of entities configured on your Citrix ADC instances.

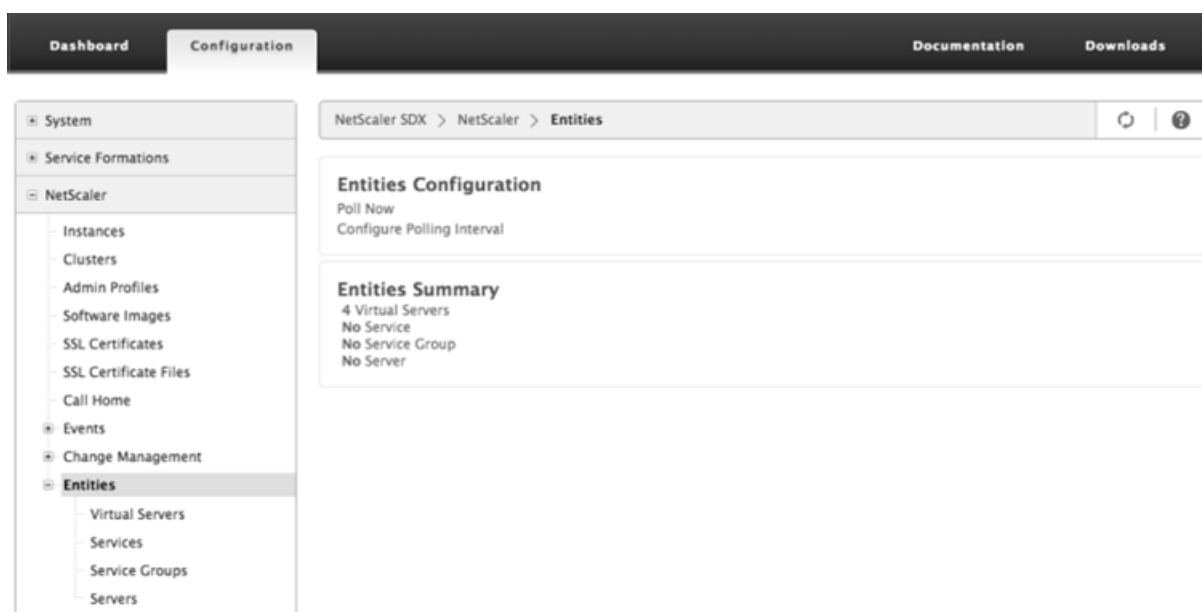

Viewing the Status of Virtual Servers

You can monitor the real-time values of the state and health of a virtual server. You can also view the attributes of a virtual server, such as name, IP address, and type of virtual server.

- To view the status of a virtual server
 1. On the Configuration tab, in the navigation pane, click Citrix ADC > Entities > Virtual Servers.
 2. In the right pane, under Virtual Servers, view the following statistics:
 - Device Name—Name of the VPX on which the virtual server is configured.
 - Name—Name of the virtual server.
 - Protocol—Service type of the virtual server. For example, HTTP, TCP, and SSL.
 - Effective State—Effective state of the virtual server, based on the state of the backup vservers. For example, UP, DOWN, or OUT OF SERVICE.
 - State—Current state of the virtual server. For example, UP, DOWN, or OUT OF SERVICE.
 - Health—Percentage of services that are in the UP state and are bound to the virtual server. The following formula is used to calculate the health percentage: $(\text{Number of bound UP services} * 100) / \text{Total bound services}$
 - IP Address—IP address of the virtual server. Clients send connection requests to this IP address.
 - Port—Port on which the virtual server listens for client connections.
 - Last State Change—Elapsed time (in days, hours, minutes, and seconds) since the last change in the state of the virtual server, that is, the duration of time for which

the virtual server has been in the current state. This information is available only for virtual servers configured on NetScaler release 9.0 and later.

The screenshot shows the NetScaler Configuration page for Virtual Servers. The left pane shows the navigation tree with 'Virtual Servers' selected. The main pane displays a table of virtual servers with columns for Device Name, Name, Protocol, Effective State, State, Health, IP Address, Port, and Last State Change.

Device Name	Name	Protocol	Effective State	State	Health	IP Address	Port	Last State Change
ns2(10.102.163.5)	v1	HTTP	Up	Up	100%	10.102.161.13	80	Mon, 10 Mar 2014 17:14:36 GMT
ns2(10.102.163.5)	v2	HTTP	Up	Up	100%	10.102.161.14	80	Mon, 10 Mar 2014 17:14:36 GMT
ns2(10.102.163.5)	v3	SSL	Up	Up	100%	10.102.161.15	443	Mon, 10 Mar 2014 17:14:36 GMT
ns2(10.102.163.5)	spotted_vip_1	HTTP	Up	Up	100%	10.102.161.16	80	Mon, 10 Mar 2014 17:14:36 GMT
ns2(10.102.163.5)	spotted_vip_2	SSL	Up	Up	100%	10.102.161.71	443	Mon, 10 Mar 2014 17:14:36 GMT
ns2(10.102.163.5)	spotted_vip_3	HTTP	Up	Up	100%	10.102.161.18	80	Mon, 10 Mar 2014 17:14:36 GMT
ns1(10.102.163.4)	v1	HTTP	Up	Up	100%	10.102.161.13	80	Mon, 10 Mar 2014 17:14:36 GMT
ns1(10.102.163.4)	v2	HTTP	Up	Up	100%	10.102.161.14	80	Mon, 10 Mar 2014 17:14:36 GMT
ns1(10.102.163.4)	v3	SSL	Up	Up	100%	10.102.161.15	443	Mon, 10 Mar 2014 17:14:36 GMT
ns1(10.102.163.4)	spotted_vip_1	HTTP	Up	Up	100%	10.102.161.16	80	Mon, 10 Mar 2014 17:14:36 GMT
ns1(10.102.163.4)	spotted_vip_2	SSL	Up	Up	100%	10.102.161.71	443	Mon, 10 Mar 2014 17:14:36 GMT
ns1(10.102.163.4)	spotted_vip_3	HTTP	Up	Up	100%	10.102.161.18	80	Mon, 10 Mar 2014 17:14:36 GMT

- Viewing Services and Service Groups Bound to a Virtual Server

You can monitor the real-time status of the services and service groups bound to a virtual server. This lets you check the state of the services that might cause the health percentage of a virtual server to become low, so that you can take appropriate action.

To view the services and service groups bound to a virtual server

1. On the Configuration tab, in the left pane, click Citrix ADC > Entities > Virtual Servers.
2. In the details pane, under Virtual Servers, click the name of the virtual server for which you want to display the bound services and service groups, and under Actions, click Bound Services or Bound Service Groups. Alternatively, right-click the name of the virtual server, and then click Bound Services or Bound Service Groups.

The screenshot shows the same NetScaler Configuration page as above, but with a context menu open over the first row of the table. The menu options are: Select Action, Enable, Disable, Bound Services, and Bound Service Groups. The table data is identical to the previous screenshot.

Viewing the Status of Services

You can monitor the real-time values of the state of a service and the duration for which the service has been in the current state.

To view the status of virtual servers

1. On the Configuration tab, in the navigation pane, click Citrix ADC > Entities > Service.
 2. In the details pane, under Services, view the following statistics:
 - Device Name—Name of the device on which the service is configured.
 - Name—Name of the service.
 - Protocol—Service type, which determines the behavior of the service. For example, HTTP, TCP, UDP, or SSL.
 - State—Current state of the service. For example, UP, DOWN, or OUT OF SERVICE.
 - IP Address—IP address of the service.
 - Port—Port on which the service listens.
 - Last State Change—Elapsed time (in days, hours, minutes, and seconds) since the last change in the state of the service, that is, the duration of time for which the service has been in the current state.
- Viewing the Virtual Servers to which a Service is Bound

You can view the virtual servers to which a service is bound and monitor the real-time status of the virtual servers.

To view the virtual servers to which a service is bound

1. On the Configuration tab, in the navigation pane, click Citrix ADC > Entities > Service.
2. In the details pane, under Services, click the name of the service for which you want to view the bound virtual servers. Then from the Action menu, select Bound Virtual Servers. Alternatively, right-click the service, and then click Bound Virtual Servers.

Name	Protocol	State	IP Address	Port	Last State Change
ns1(10.102.163.5)	HTTP	Up	172.16.200.100	80	Mon, 10 Mar 2014 17:14:36 GMT
ns2(10.102.163.5)	HTTP	Up	172.16.200.101	80	Mon, 10 Mar 2014 17:14:36 GMT
ns2(10.102.163.5)	HTTP	Up	172.16.200.102	80	Mon, 10 Mar 2014 17:14:36 GMT
ns2(10.102.163.5)	HTTP	Up	172.16.200.103	80	Mon, 10 Mar 2014 17:14:36 GMT
ns2(10.102.163.5)	HTTP	Up	172.16.200.104	80	Mon, 10 Mar 2014 17:14:36 GMT
ns2(10.102.163.5)	HTTP	Up	172.16.200.105	80	Mon, 10 Mar 2014 17:14:36 GMT
ns2(10.102.163.5)	HTTP	Up	172.16.200.106	80	Mon, 10 Mar 2014 17:14:36 GMT
ns2(10.102.163.5)	HTTP	Up	172.16.200.107	80	Mon, 10 Mar 2014 17:14:36 GMT
ns2(10.102.163.5)	HTTP	Up	172.16.200.108	80	Mon, 10 Mar 2014 17:14:36 GMT
ns2(10.102.163.5)	HTTP	Up	172.16.200.109	80	Mon, 10 Mar 2014 17:14:36 GMT
ns2(10.102.163.5)	HTTP	Up	172.16.200.110	80	Mon, 10 Mar 2014 17:14:36 GMT
ns1(10.102.163.4)	HTTP	Up	172.16.200.100	80	Mon, 10 Mar 2014 17:14:36 GMT

Viewing the Status of Service Groups

You can monitor the real-time state of a service group member from the SDX interface.

To view the status of service groups

1. On the Configuration tab, in the navigation pane, click Citrix ADC > Entities > Service Groups.
2. In the details pane, under Service Groups, view the following statistics:
 - Device Name—Name of the device on which the service group is configured.
 - Name—Name of the service group.
 - IP Address—IP address of each service that is a member of the service group.
 - Port—Ports on which the service group members listen .
 - Protocol—Service type, which determines the behavior of the service group. For example, HTTP, TCP, UDP, or SSL.
 - Effective State—Effective state of the virtual server group, based on the state of the backup virtual servers. For example, UP, DOWN, or OUT OF SERVICE
 - State—Effective state of the service group, which is based on the state of the member of the service group. For example, UP, DOWN, or OUT OF SERVICE.
 - Last State Change—Elapsed time (in days, hours, minutes, and seconds) since the last change in the state of the service group member, that is, the duration of time for which the service group member has been in the current state. This information is available only for service group members configured on NetScaler release 9.0 and later.

- Viewing the Virtual Servers to which a Service is Bound

You can view the virtual servers to which a service is bound and monitor the real-time status of the virtual servers.

To view the virtual servers to which the service is bound

1. On the Configuration tab, in the left pane, click Citrix ADC > Entities > Servers.
2. In the right pane, under Servers, select the server from the list, and under Actions menu, click Bound Virtual Services. Alternately, right-click the service and click Bound Virtual Servers.

Viewing the Status of Servers

You can monitor and manage the states of servers across the Citrix® ADC instances. This gives you visibility into the real-time status of the servers and makes management of these servers easy when you have a large number of servers.

To view the status of servers

1. On the Configuration tab, in the navigation pane, click Citrix ADC > Entities > Servers.

2. In the details pane, under Servers, view the following statistics:

- Device Name: Specifies the name of the device on which the server is configured.
- Name: Specifies the name of the server.
- IP Address: Specifies the IP address of the server. Clients send connection requests to this IP address.
- State: Specifies the current state of the server. For example, UP, DOWN, and OUT OF SERVICE.
- Last State Change: Specifies the time elapsed (in days, hours, minutes, and seconds) since the last change in the state of the server, that is, the duration of time for which the server is in the current state.

Name	IP Address	State	Last State Change
ns2(10.102.163.5)	172.16.200.100	Enabled	Mon, 10 Mar 2014 17:14:36 GMT
ns2(10.102.163.5)	172.16.200.101	Enabled	Mon, 10 Mar 2014 17:14:36 GMT
ns2(10.102.163.5)	172.16.200.102	Enabled	Mon, 10 Mar 2014 17:14:36 GMT
ns2(10.102.163.5)	172.16.200.103	Enabled	Mon, 10 Mar 2014 17:14:36 GMT
ns2(10.102.163.5)	172.16.200.104	Enabled	Mon, 10 Mar 2014 17:14:36 GMT
ns2(10.102.163.5)	172.16.200.105	Enabled	Mon, 10 Mar 2014 17:14:36 GMT
ns2(10.102.163.5)	172.16.200.106	Enabled	Mon, 10 Mar 2014 17:14:36 GMT
ns2(10.102.163.5)	172.16.200.107	Enabled	Mon, 10 Mar 2014 17:14:36 GMT
ns2(10.102.163.5)	172.16.200.108	Enabled	Mon, 10 Mar 2014 17:14:36 GMT
ns2(10.102.163.5)	172.16.200.109	Enabled	Mon, 10 Mar 2014 17:14:36 GMT
ns2(10.102.163.5)	172.16.200.110	Enabled	Mon, 10 Mar 2014 17:14:36 GMT
ns1(10.102.163.4)	172.16.200.100	Enabled	Mon, 10 Mar 2014 17:14:36 GMT

Configuring the Polling Interval

You can set the time interval for which you want the SDX appliance to poll the real-time values of the virtual servers, services, service groups, and servers. By default, the appliance polls the values every 30 minutes.

- To configure the polling interval for virtual servers, services, service groups, and Servers.
 1. On the Configuration tab, click Citrix ADC > Entities, and in the right pane, click Configure Polling Interval.
 2. In the Configure Polling Interval dialog box, type the number of minutes you want to set as the time interval for which SDX must poll the entity value. Minimum value of the polling interval is 30 minutes. Click OK.

Monitoring and Managing Events Generated on Citrix® ADC instances

September 27, 2025

Use the Events feature to monitor and manage the events generated on the Citrix ADC instances. The Management Service identifies events in real time, thereby helping you address issues immediately and keep the Citrix ADC instances running effectively. You can also configure event rules to filter the events generated and get notified to take actions on the filtered list of events.

Viewing All Events

You can view all the events generated on the Citrix ADC instances provisioned on the NetScaler SDX appliance. You can view the details such as severity, category, date, source, and message for the each of the events.

To view the events, navigate to Configuration > Citrix ADC > Events > All Events

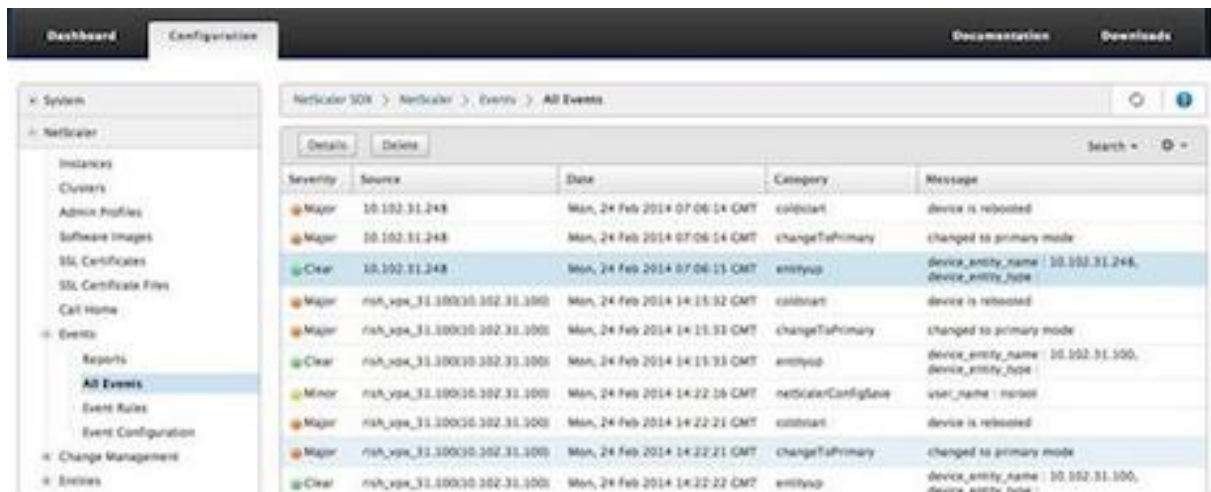

You can view the event history and entity details by selecting the event and clicking the Details button. You can also search for a particular event or delete it from this page.

Note: After you delete the events, you will not be able to recover them.

- Viewing Reports

The Reports page displays the events summary in a graphical format. Your view of the reports can be based on various time scales. By default the time scale is Day.

To display the reports, navigate to Configuration > Citrix ADC > Events > Reports. Following are the graphical reports supported on the Management Service

- Events

The Events report is a pie chart representation of the number of events, segmented and color coded on the basis of their severity.

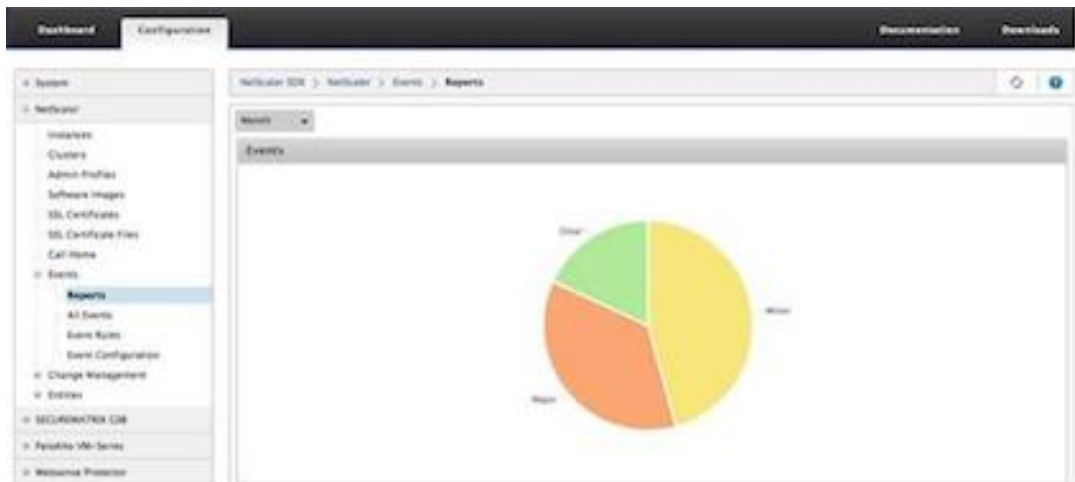

To view the details of the events of a particular severity, click that segment of the pie chart, you can view the following details:

- Source: System name, host name, or the IP address on which the event was generated.
- Date: Date and time when the alarm was generated.
- Category: Event category (for example, entityup).
- Message: Description of the event.

• **Top 10 Citrix ADC instances by All Events**

This report is a bar chart that displays the top 10 Citrix ADC instances according to the number of events for the selected time scale.

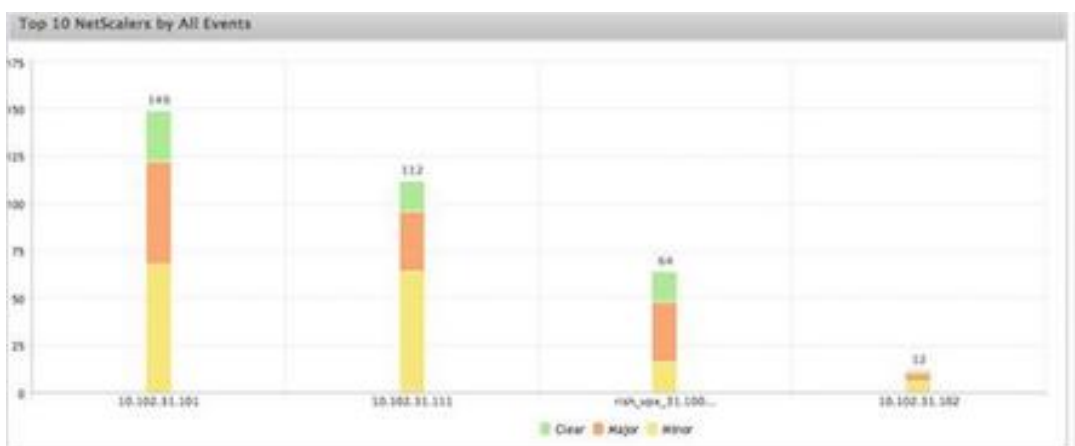

• **Top 10 Citrix ADC instances by Entity State Change Events**

This report is a bar chart that displays the top 10 Citrix ADC instances according to the number of entity state changes for the selected time scale. The entity state changes reflect

entity up, entity down, or out of service events.



- **Top 10 Citrix ADC instances by Threshold Violation Events**

This report is a bar chart that displays the top 10 Citrix ADC instances according to the number of threshold violation events for the selected time scale. The threshold violation events reflect the following events:

- cpuUtilization
- memoryUtilization
- diskUsageHigh
- temperatureHigh
- voltageLow
- voltageHigh
- fanSpeedLow
- temperatureCpuHigh
- interfaceThroughputLow
- interfaceBWUseHigh
- aggregateBWUseHigh

- **Top 10 Citrix ADC instances by Hardware Failure Events**

This report is a bar chart that displays the top 10 Citrix ADC instances according to the number of hardware failure events for the selected time scale. The hardware failure events reflect the following events:

- hardDiskDriveErrors
- compactFlashErrors
- powerSupplyFailed
- “sslCardFailed”

- **Top 10 Citrix ADC instances by Configuration Change Events**

This report is a bar chart that reflects the top 10 Citrix ADC instances according to the num-

ber of configuration change events for the selected time scale. You can click on the chart to drill down and view the user based configuration changes for a particular instance. You can further view the authorization and execution status details by clicking on this chart.

- **<Top 10 Citrix ADC instances by Authentication Failure Events**

This report is a bar chart that displays the top 10 Citrix ADC instances according to the number of authentication failure events for the selected time scale. You can click on the chart to drill down and view the user based authentication failures for a particular instance.

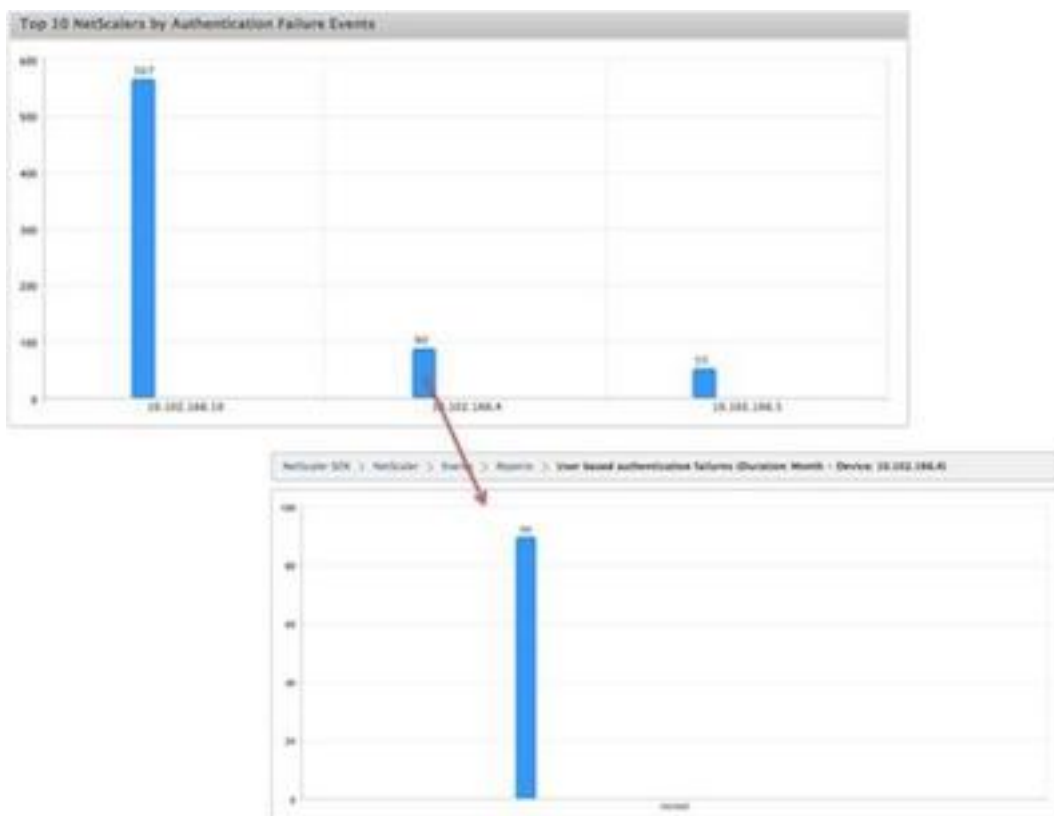

- **Configuring Event Rules**

You can filter a set of events by configuring rules with specific conditions and assigning actions to the rules. When the events generated meet the filter criteria in the rule, the action associated with the rule is executed. The conditions for which you can create filters are: severity, devices, failure objects, and category.

You can assign the following actions to the events:

- **Send e-mail Action:** Sends an email for the events that match the filter criteria.
- **Send SMS Action:** Sends an Short Message Service(SMS) for the events that match the filter criteria.

To add event rules

1. Navigate to Configuration > Citrix ADC > Events > Event Rules, and click Add.
2. On the Rule page set the following parameters:
 - Name—Name of the event rule.
 - Enabled—Enable the event rule.
 - Severity—Severity of the events for which you want to add the event rule.
 - Devices—IP addresses of the Citrix ADC instances for which you want to define a event rule.
 - Category—Category or categories of the events generated by the Citrix ADC instances.
 - Failure Objects—Entity instances or counters for which an event has been generated.



Note: This list can contain counter names for all threshold-related events, entity names for all entity-related events, and certificate names for certificate-related events.

3. Click Save.
4. Under Rule Actions, you can assign the notification actions for the event.
 - a) Mail Profile—Mail server and mail profile details. An email is triggered when the events meet the defined filter criteria.
 - b) SMS Profile—SMS server and SMS profile details. An SMS is triggered when the events meet the defined filter criteria.

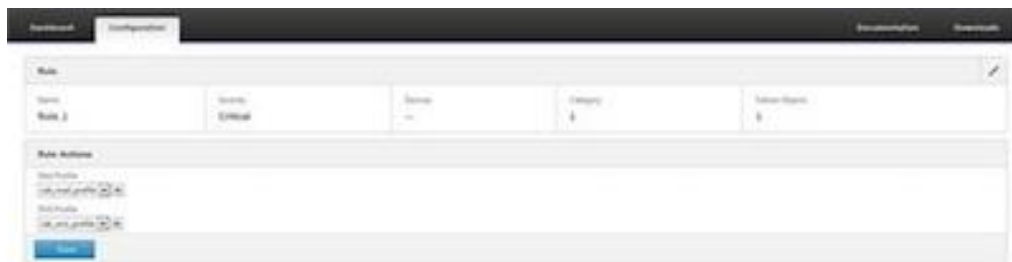

5. Click Done.

- **Configuring Events**

You can assign severity levels to events that are generated for the Citrix ADC instances on the SDX appliance. You can define the following types of severity levels: Critical, Major, Minor, Warning, Clear, and Information. You can also suppress the events for a specific time.

To configure severity:

1. Navigate to Configuration > Citrix ADC > Events > Event Configuration, select the event from the list, and then click Configure Severity.



2. On the Configure Events Configuration page, select the required severity level from the drop-down list.
3. Alternatively, you can suppress the events by selecting the Suppress check box. You can also specify the Citrix ADC instances for which you want to suppress this event by using the Advanced option.

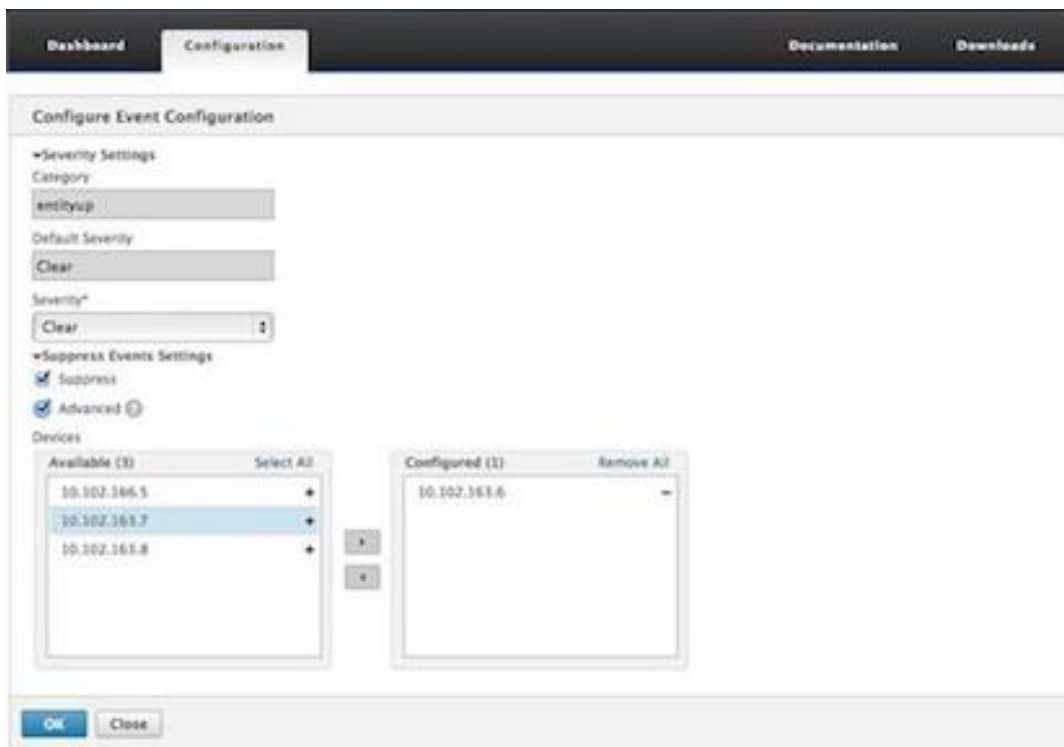

4. Click OK.

Call Home Support for Citrix® ADC instances on an SDX Appliance

September 27, 2025

The Call Home feature monitors your Citrix ADC instances for common error conditions. You can now configure, enable or disable the Call Home feature on Citrix ADC instances from the Management Service user interface.

Note: The Citrix ADC instance has to be registered with the Citrix Technical Support server before Call Home can upload the system data to the server when predefined error conditions occur on the appliance. Enabling the Call Home feature on the Citrix ADC instance initiates the registration process.

- Enabling and Disabling Call Home on a Citrix ADC instance

You can enable the Call Home feature on Citrix ADC instance from the Management Service. When you enable the Call Home feature, the Call Home process registers the Citrix ADC instance with the Citrix Technical Support server. The registration takes some time to complete. During that time, the Management Service displays the progress of registration..

To enable the Call Home feature, navigate to Configuration > Citrix ADC > Call Home, select the Citrix ADC instance, and click the Enable button. In the confirmation page, click Yes.

To disable the Call Home feature, navigate to Configuration > Citrix ADC > Call Home, select the Citrix ADC instance, and click the Disable button. On the confirmation page, click Yes.

If you enable Call Home, you can configure the following options:

1. (Optional) Specify the administrator's email address. The Call Home process sends the email address to the Support server, where it is stored for future correspondence regarding Call Home.
 2. (Optional) Enable Call Home proxy mode. Call Home can upload your Citrix ADC instance's data to the Citrix TaaS server through a proxy server. To use this feature, enable it on your Citrix ADC instance and specify the IP address and port number of an HTTP proxy server. All traffic from the proxy server to the TaaS servers (over the Internet) is over SSL and encrypted, so data security and privacy are not compromised.
- To configure Call home on the Citrix ADC instance from the Management Service

You can configure the Call Home feature on a single instance or on multiple instances at the same time.

To configure Call Home feature on a single Citrix ADC instance, navigate to Configuration > Citrix ADC > Call Home, select the Citrix ADC instance and click Configure button. In the Configure Call Home page, click OK.

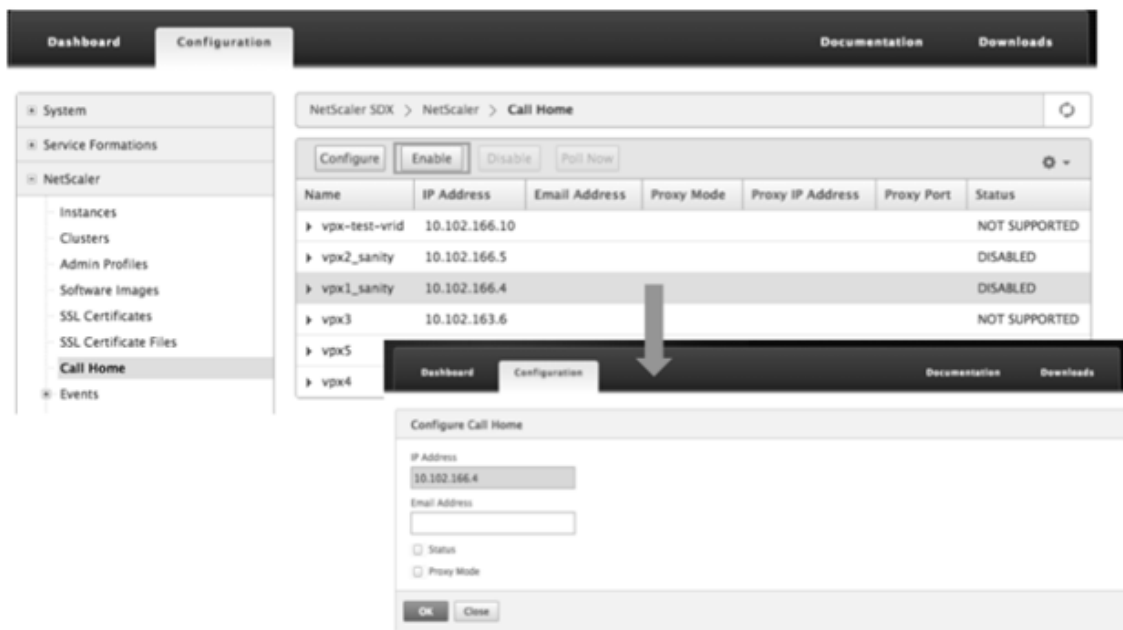

To configure Call Home feature on a multiple Citrix ADC instances, navigate to Configuration > Citrix ADC, in the right pane, click Call Home, on the Configure Call Home page, select the Citrix ADC instances from the Available Instances section, specify other details, and click OK.

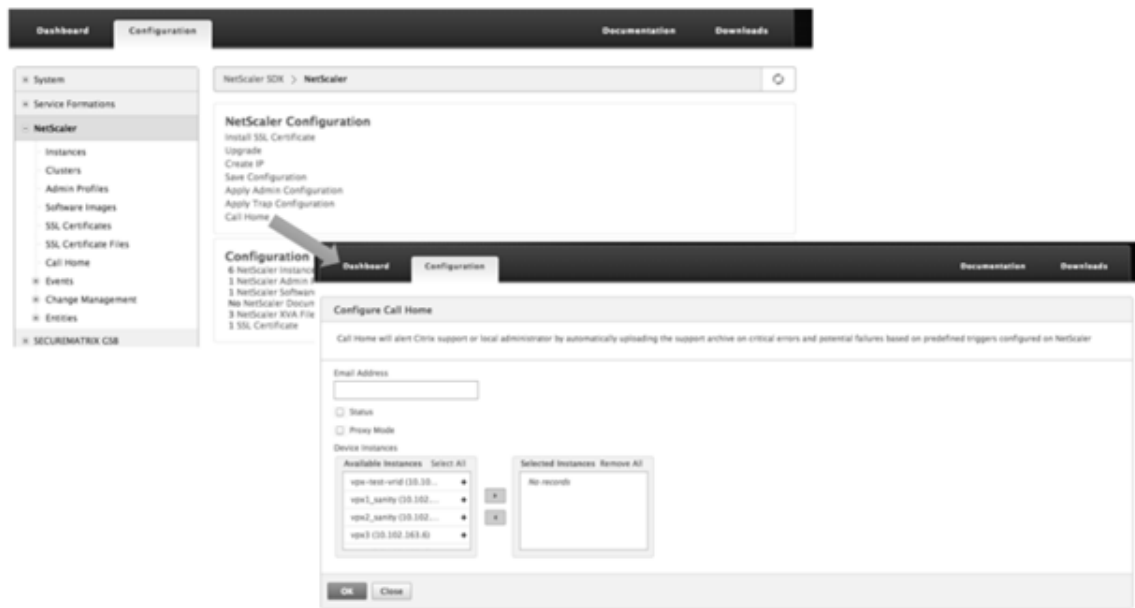

- Polling the Citrix ADC instances

To poll the Call Home feature from all Citrix ADC instances and view the current status, navigate to Configuration > Citrix ADC > Call Home, and click Poll Now button. On the confirmation page, click Yes.

System Health Monitoring

September 27, 2025

System health monitoring detects errors in the monitored components, so that you can take corrective action to avoid a failure. The following components are monitored on a NetScaler SDX appliance:

- Hardware and software resources
- Physical and virtual disks
- <Hardware sensors, such as fan, temperature, voltage, and power supply sensors
- Interfaces

In the Monitoring tab, click System Health. A summary of all the components is displayed. To view details of the monitored components, expand System Health, and then click the component that you want to monitor.

- Monitoring the Resources on the SDX Appliance

You can monitor the hardware and software components on the SDX appliance and take corrective action if required. To view the components monitored, in the Monitoring tab, expand System Health, and then click Resources. Details are displayed for hardware and software resources. For all hardware components, current and expected values are displayed. For software components, except the BMC firmware version, current and expected values are displayed as not applicable (NA).

- **Name**

Name of the component, such as CPU, memory, or BMC firmware version.

- **Status**

State (condition) of the component. For

Hardware and for

BMC Firmware Version, ERROR indicates a deviation from the expected value. For calls to Citrix Hypervisor™, ERROR indicates that the Management Service is unable to communicate with Citrix Hypervisor by using an API, HTTP, PING, or SSH call. For Health Monitor Plugin, ERROR indicates that the plugin is not installed on Citrix Hypervisor.

- **Current Value**

Current value of the component. In normal conditions, current value is the same as the expected value.

- **Expected Value**

Expected value for the component. Does not apply to software calls to Citrix Hypervisor.

Monitoring the Storage Resources on the SDX Appliance

You can monitor the disks on the SDX appliance and take corrective action if required. To view the components monitored, in the Monitoring tab, expand System Health, and then click Storage. Details are displayed for physical disks and for virtual disks or partitions created from physical disks.

For disks (Disk), the following details are displayed:

- **Name**

Name of the physical disk.

- **Size**

Size of the disk, in gigabytes (GB).

- **Utilized**

Amount of data on the disk, in gigabytes (GB).

- **Transactions/s**

Number of blocks being read or written per second. This number is read from the iostat output.

- **Blocks Read/s**

Number of blocks being read per second. You can use this value to measure the rate of output from the disk.

- **Blocks Written/s**

Number of blocks being written per second. You can use this value to measure the rate of input to the disk.

- **Total Blocks Read**

Number of blocks read since the appliance was last started.

- **Total Blocks Written**

Number of blocks written since the appliance was last started.

For virtual disks or partitions (Storage Repository), the following details are displayed:

- **Drive Bay**

Number of the drive in the drive bay. You can sort the data on this parameter.

- **Status**

State (condition) of the drive in the drive bay. Possible values:

- GOOD: The drive is in a good state and is ready for use.
- FAIL: The drive has failed and has to be replaced.
- MISSING: A drive is not detected in the drive bay.
- UNKNOWN: A new unformatted drive exists in the drive bay.

- **Name**

System defined name of the storage depository.

- **Size**

Size of the storage repository, in gigabytes (GB).

- **Utilized**

Amount of data in the storage repository, in gigabytes (GB).

Monitoring the Hardware Sensors on the SDX Appliance

You can monitor the hardware components on the SDX appliance and take corrective action if required. In the Monitoring tab, expand System Health, and then click Hardware Sensors. The monitoring function displays details about the speed of different fans, the temperature and voltage of different components, and the status of the power supply.

For fan speed, the following details are displayed:

- **Name**

Name of the fan.

- **Status**

State (condition) of the fan. ERROR indicates a deviation from the expected value. NA indicates that the fan is not present.

- **Current Value (RPM)**

Current rotations per minute.

Temperature information includes the following details:

- **Name**

Name of the component, such as CPU or memory module (for example, P1-DIMM1A.)

- **Status**

State (condition) of the component. ERROR indicates that the current value is out of range.

- **Current Value (Degree C)**

Current temperature, in degrees, of the component.

Voltage information includes the following details:

- **Name**

Name of the component, such as CPU core.

- **Status**

State (condition) of the component. ERROR indicates that the current value is out of range.

- **Current Value (Volts)**

Current voltage present on the component.

Information about the power supply includes the following details:

- **Name**

Name of the component.

- **Status**

State (condition) of the component. Possible values:

- **Error:** Only one power supply is connected or working.
- **OK:** Both the power supplies are connected and working as expected.

Monitoring the Interfaces on the SDX Appliance

You can monitor the interfaces on the SDX appliance and take corrective action if required. In the Monitoring tab, expand System Health, and then click Interfaces. The monitoring function details the following information about each interface:

- **Interface**

Interface number on the SDX appliance.

- **Status**

State of the interface. Possible values: UP, DOWN.

- **VFs Assigned/Total**

Number of virtual functions assigned to the interface, and the number of virtual functions available on that interface. Different platforms support a different number of VFs.

- **Tx Packets**

Number of packets transmitted since the appliance was last started.

- **Rx Packets**

Number of packets received since the appliance was last started.

- **Tx Bytes**

Number of bytes transmitted since the appliance was last started.

- **Rx Bytes**

Number of bytes received since the appliance was last started.

- **Tx Errors**

Number of errors in transmitting data since the appliance was last started.

- **Rx Errors**

Number of errors in receiving data since the appliance was last started.

Configuring System Notification Settings

September 27, 2025

You can send notifications to communicate with select groups of users for a number of system-related functions. You can set up a notification server in SDX Management Service to configure email and Short Message Service (SMS) gateway servers to send email and text (SMS) notifications to users.

Note

After you upgrade to SDX Management Service release 11.1, system notification is enabled for all the event categories, and the notifications are sent to the existing email or SMS profile.

To configure system notification settings

1. Navigate to **System > Notifications > Settings**, and then click **Change Notification Settings**.
2. In the **Configure System Notification Settings** page, enter the following details:
 - **Category** –Category or categories of the events generated by the SDX Management Service.
 - **Email** –Select an email distribution list from the drop-down menu. You can also create a new email distribution list by clicking on the **+** icon and entering the new email server details in the appropriate fields.
 - **SMS (Text Message)** –Select an SMS distribution list from the drop-down menu. You can also create a new SMS distribution list by clicking on the **+** icon and entering the new SMS server details in the appropriate fields.
3. Click **OK**.

Configuring the Management Service

September 27, 2025

The Management Service lets you manage client sessions and perform configuration tasks, such as creating and managing user accounts and tweaking backup and pruning policies according to your requirements. You can also restart the Management Service and upgrade the version of the Management Service. You can further create tar files of the Management Service and the Citrix Hypervisor™ and send it to technical support.

If a task that you need to perform is not described below, see the list of tasks at the left.

Managing Client Sessions

A client session is created when a user logs on to the Management Service. You can view all the client sessions on the appliance in the Sessions pane.

In the Sessions pane, you can view the following details:

- User Name
The user account that is being used for the session.
- IP Address
The IP address of the client from which the session has been created.
- Port
The port being used for the session.
- Login Time
The time at which the current session was created on the SDX appliance.
- Last Activity Time
The time at which user activity was last detected in the session.
- Session Expires In
Time left
for session expiry.

To view client sessions, on the Configuration tab, in the navigation pane, expand System, and then click Sessions.

To end a client session, in the Sessions pane, click the session you want to remove, and then click End Session.

You cannot end a session from the client that has initiated that session.

Configuring Policies

To keep the size of logged data within manageable limits, the SDX appliance runs backup and data-pruning policies automatically at a specified time.

The prune policy runs at 00:00 A.M every day and specifies the number of days of data to retain on the appliance. By default, the appliance prunes data older than 3 days, but you can specify the number of days of data that you want to keep. Only event logs, audit logs, and task logs are pruned.

The backup policy runs at 00:30 A.M. every day and creates a backup of logs and configuration files. By default, the policy retains three backups, but you can specify the number of backups you want to keep. And, using the backup policy, you can:

- Encrypt the backup files.
- Configure the SDX appliance to transfer the backup files to an external backup server using FTP, SFTP, and SCP.

To specify the number of days for which logged data is pruned:

1. On the **Configuration** tab, in the navigation pane, click **System**.
2. In the **System** pane, under **Policy Administration**, click **Prune Policy**.
3. In the **Modify Prune Policy** dialog box, in **Data to keep (days)**, specify the number of days of data that the appliance must retain at any given time.
4. Click **OK**.

To configure the backup policy:

1. On the **Configuration** tab, in the navigation pane, click **System**.
2. In the **System** pane, under **Policy Administration**, click **Backup Policy**.
3. In the **Modify Backup Policy** dialog box, in **#Previous Backups** to retain, specify the number of backups that the appliance must retain at any given time.
4. Select **Encrypt Backup File** to encrypt the backup file.
5. Select **External Transfer** and do the following to transfer the backup file to a external backup server:
 - a) In the **Server** field, enter hostname or IP address of the external backup server.
 - b) In the **User Name** and **Password** fields, enter the username and password to access the external backup server.
 - c) In the **Port** field, enter the port number.
 - d) In the **Transfer Protocol** field, select the protocol you want to use to transfer the backup file to the external backup server.
 - e) In the **Directory Path** field, enter the path of the directory in the external backup server where you want to store the backup files.
6. Select **Delete file from Management Service after transfer** if you want to delete the backup file from the SDX appliance after you have transfered the backup file to the external backup server.
7. Click **OK**.

Restarting the Management Service

You can restart the Management Service from the System pane. Restarting the Management Service does not affect the working of the instances. The instances continue to function during the Management Service restart process.

To restart the Management Service:

1. On the **Configuration** tab, in the navigation pane, click **System**.
2. In the **System** pane, under **System Administration**, click **Reboot Management Service**.

Removing Management Service Files

Updated: 2013-10-07

You can remove any unneeded Management Service build and documentation files from the SDX appliance.

To remove a Management Service file:

1. On the **Configuration** tab, in the navigation pane, expand **Management Service**, and then click the file that you want to remove.
2. In the **details** pane, select the file name, and then click **Delete**.

Generating a Tar Archive for Technical Support

You can use the Technical Support option to generate a tar archive of data and statistics for submission to Citrix® technical support. This tar can be generated for the Management Service or the Citrix Hypervisor, or for both at the same time. You can then download the file to your local system and send it to Citrix technical support.

In the Technical Support pane, you can view the following details.

- Name
The name of the tar archive file. The file name indicates whether the tar is for the Management Service or the Citrix Hypervisor server.
- Last Modified
The date when this file was last modified.
- Size
The size of the tar file.

To generate the tar archive for technical support:

1. On the **Configuration** tab, navigate to **Diagnostics > Technical Support**.
2. In the **details** pane, from the **Action** list, select **Generate Technical Support File**.
3. In the **Generate Technical Support File** dialog box, from the **Mode** list, select the appropriate option for whether you want to archive data of Citrix Hypervisor, Management Service, Appliance (including Citrix Hypervisor and Management Service), Instances, or Appliance (including instances).

4. Click **OK**.

To download the tar archive for technical support:

1. In the **Technical Support** pane, select the technical support file that you want to download.
2. From the **Action** list, select **Download**. The file is saved to your local computer.

Command Line Interface support for Management Service

You can now use the command line interface to perform operations on the Management Service. The following operations are supported:

- Add, Set, Delete—To configure the resources.
- Do—To perform system level operations. For example, management service upgrade or shut-down, or reboot.
- Save—To add interfaces, which are used for Citrix provisioning.

To access the CLI, start the secure shell (SSH) client from any workstation connected to the Management Service IP address. Log on by using the administrator credentials.

You can access detailed information about command usage and syntax from the man pages.

Note: CLI is not supported over console access.

Configuring Authentication and Authorization Settings

September 27, 2025

Authentication with the NetScaler SDX Management Service can be local or external. With external authentication, the Management Service grants user access based on the response from an external server. The Management Service supports the following external authentication protocols:

- Remote Authentication Dial In User Service (RADIUS)
- Terminal Access Controller Access-Control System (TACACS)
- Lightweight Directory Access Protocol (LDAP)

The Management Service also supports authentication requests from SSH. The SSH authentication supports only keyboard-interactive authentication requests. The authorization of SSH users is limited to admin privileges only. Users with read-only privileges cannot log on through SSH.

To configure authentication, specify the authentication type, and configure an authentication server.

Authorization through the Management Service is local. The Management Service supports two levels of authorization. Users with admin privileges are allowed to perform any action on the management service. Users with read-only privileges are allowed to perform only read operations. The authorization of SSH users is limited to admin privileges only. Users with read-only privileges cannot log on through SSH.

Authorization for RADIUS and LDAP is supported by group extraction. You can set the group extraction attributes during the configuration of RADIUS or LDAP servers on the Management Service. The extracted group name is matched with the group names on the Management Service to determine the privileges given to the user. A user can belong to multiple groups. In that case, if any group to which the user belongs has admin privileges, the user has admin privileges. A Default Authentication group attribute can be set during configuration. This group is considered along with the extracted groups for authorization.

In the case of TACACS authorization, the TACACS server administrator must permit a special command, `admin` for a user who is to have admin privileges and deny this command for users with read-only privileges. When a user logs on to SDX appliance, the Management Service checks if the user has permission to execute this command and if the user has permission, the user is assigned the admin privileges else the user is assigned read-only privileges.

Adding a User Group

Groups are logical sets of users that need to access common information or perform similar kinds of tasks. You can organize users into groups defined by a set of common operations. By providing specific permissions to groups rather than individual users, you can save time when creating users.

If you are using external authentication servers for authentication, groups in SDX can be configured to match groups configured on authentication servers. When a user belonging to a group whose name matches a group on an authentication server, logs on and is authenticated, the user inherits the settings for the group in SDX appliance.

To add a user group

1. On the **Configuration** tab, under **System**, expand **User Administration**, and then click **Groups**.
2. In the details pane, click **Add**.

← Create System Group

Group Name*
 ⓘ × Please enter value

Group Description

System Access

Permission*
read-write ▼ ⓘ

Configure User Session Timeout

Users

Available (2)	Select All		Configured (0)	Remove All
nsroot	+	▶	No items	
config-user	+	◀		

All Instances

Create

3. In the **Create System Group** page, set the following parameters:

- Group Name
- Group Description
- System Access: Select this box to give access to the entire SDX appliance and the instances running on it. Alternatively, for instance-level access, specify the instances under **Instances**.
- Permission
- Configure User Session Timeout
- Users: Database users belonging to the Group. Select the users you want to add to the group.

4. Click **Create** and **Close**.

Note

To create a group with admin role on an SDX appliance that is upgraded from version 10.5 to 11.1, select the “read-write” permission and “System Access” check box. In SDX 10.5, this check box is not available and the values for Permission are “admin” and “read-only”.

Configuring User Accounts

A user logs on to the SDX appliance to perform appliance management tasks. To allow a user to access the appliance, you must create a user account on the SDX appliance for that user. Users are authenticated locally, on the appliance.

Important: The password applies to the SDX appliance, Management Service, and Citrix Hypervisor. Do not change the password directly on the Citrix Hypervisor.

To configure a user account

1. On the **Configuration** tab, under **System**, expand **Administration**, and then click **Users**. The Users pane displays a list of existing user accounts, with their permissions.
2. In the Users pane, do one of the following:
 - To create a user account, click Add.
 - To modify a user account, select the user, and then click Modify.
3. In the Create System User or Modify System User dialog box, set the following parameters:
 - **Name***—The user name of the account. The following characters are allowed in the name: letters a through z and A through Z, numbers 0 through 9, period (.), space, and underscore (_). Maximum length: 128. You cannot change the name.
 - **Password***—The password for logging on to the appliance. Maximum length: 128
 - **Confirm Password***—The password.
 - **Permission***—The user’s privileges on the appliance. Possible values:
 - **admin**—The user can perform all administration tasks related to the Management Service.
 - **read-only**—The user can only monitor the system and change the password of the account.
Default: admin.
 - **Enable External Authentication**—Enables external authentication for this user. Management Service attempts external authentication before database user authentication. If

this parameter is disabled, user is not authenticated with the external authentication server.

- **Configure Session Timeout**—Enables you to configure the time period for how long a user can remain active. Specify the following details:
 - **Session Timeout**—The time period for how long a user session can remain active.
 - **Session Timeout Unit**—The timeout unit, in minutes or hours.
- **Groups**—Assign the groups to the user.

*A required parameter

4. Click **Create** or **OK**, and then click **Close**. The user that you created is listed in the **Users** pane.

To remove a user account

1. On the **Configuration** tab, in the navigation pane, expand **System**, expand **Administration**, and then click **Users**.
2. In the **Users** pane, select the user account, and then click **Delete**.
3. In the **Confirm** message box, click **OK**.

Setting the Authentication type

From the **Management Service** interface, you can specify local or external authentication. External authentication is disabled for local users by default. It can be enabled by checking the **Enable External Authentication** option when adding the local user or modifying the settings for the user.

Important: External authentication is supported only after you set up a **RADIUS**, **LDAP**, or **TACACS** authentication server.

To set the authentication type

1. On the **Configuration** tab, under **System**, click **Authentication**.
2. In the details pane, click **Authentication Configuration**.
3. Set the following parameters:
 - **Server Type**—Type of authentication server configured for user authentication. Possible values: **LDAP**, **RADIUS**, **TACACS**, and **Local**.
 - **Server Name**—Name of the authentication server configured in the **Management Service**. The menu lists all the servers configured for the selected authentication type.

- Enable fallback local authentication—Alternatively, you can choose to authenticate a user with the local authentication when external authentication fails. This option is enabled by default.
4. Click OK.

Enable or Disable Basic Authentication

You can authenticate to the Management Service NITRO interface using basic authentication. By default, basic authentication is enabled in the SDX appliance. Perform the following to disable basic authentication using the Management Service interface.

To disable basic authentication

1. On the **Configuration** tab, click **System**.
2. In the **System Settings** group, click **Change System Settings**.
3. In the Configure System Settings dialog box, clear the **Allow Basic Authentication** check box.
4. Click **OK**.

Configuring the External Authentication Server

September 27, 2025

The NetScaler SDX Management Service can authenticate users with local user accounts or by using an external authentication server. The appliance supports the following authentication types:

- Local—Authenticates to the Management Service by using a password, without reference to an external authentication server. User data is stored locally on the Management Service.
- RADIUS—Authenticates to an external RADIUS authentication server.
- LDAP—Authenticates to an external LDAP authentication server.
- TACACS—Authenticates to an external Terminal Access Controller Access-Control System (TACACS) authentication server.

To configure an external authentication, specify the authentication type, and configure an authentication server.

Adding a RADIUS Server

To configure RADIUS authentication, specify the authentication type as RADIUS, and configure the RADIUS authentication server.

Management Service supports RADIUS challenge response authentication according to the RADIUS specifications. RADIUS users can be configured with a one-time password on RADIUS server. When the user logs on to SDX appliance the user is prompted to specify this one time password.

To add a RADIUS server

1. On the **Configuration** tab, under **System**, expand **Authentication**, and then click **Radius**.
2. In the details pane, click **Add**.
3. In the Create Radius Server dialogue box, type or select values for the parameters:
 - **Name***—Name of the server.
 - **Server Name / IP Address***—FQDN or Server IP address.
Note: DNS should be able to resolve the specified fully qualified domain name (FQDN) to an IP address, and only the primary DNS is used to resolve the FQDN. To manually set the primary DNS, see the section “Adding a Primary DNS for FQDN Name Resolution.”
 - **Port***—Port on which the RADIUS server is running. Default value: 1812.
 - **Time-out***—Number of seconds the system will wait for a response from the RADIUS server. Default value: 3.
 - **Secret Key***—Key shared between the client and the server. This information is required for communication between the system and the RADIUS server.
 - **Enable NAS IP Address Extraction**—If enabled, the system’s IP address (Management Service IP) is sent to the server as the “nasip” in accordance with the RADIUS protocol.
 - **NASID**—If configured, this string is sent to the RADIUS server as the “nasid” in accordance with the RADIUS protocol.
 - **Group Prefix**—Prefix string that precedes group names within a RADIUS attribute for RADIUS group extraction.
 - **Group Vendor ID**—Vendor ID for using RADIUS group extraction.
 - **Group Attribute Type**—Attribute type for RADIUS group extraction.
 - **Group Separator**—Group separator string that delimits group names within a RADIUS attribute for RADIUS group extraction.
 - **IP Address Vendor Identifier**—Vendor ID of the attribute in the RADIUS which denotes the intranet IP. A value of 0 denotes that the attribute is not vendor encoded.
 - **IP Address Attribute Type**—Attribute type of the remote IP address attribute in a RADIUS response.
 - **Password Vendor Identifier**—Vendor ID of the password in the RADIUS response. Used to extract the user password.
 - **Password Attribute Type**—Attribute type of the password attribute in a RADIUS response.
 - **Password Encoding**—How passwords should be encoded in the RADIUS packets traveling from the system to the RADIUS server. Possible values: pap, chap, mschapv1, and mschapv2.

- **Default Authentication Group**—Default group that is chosen when the authentication succeeds in addition to extracted groups.
 - **Accounting**—Enable Management Service to log audit information with RADIUS server.
4. Click **Create**, and then, click **Close**.

Adding an LDAP Authentication Server

To configure LDAP authentication, specify the authentication type as LDAP, and configure the LDAP authentication server.

To add an LDAP server

1. On the **Configuration** tab, under **System**, expand **Authentication**, and then click **LDAP**.
2. In the details pane, click **Add**.
3. In the Create LDAP Server dialogue box, type or select values for the parameters:
 - **Name***—Name of the server.
 - **Server Name / IP Address***—FQDN or Server IP address.
Note: DNS should be able to resolve the specified FQDN to an IP address, and only the primary DNS is used to resolve the FQDN. To manually set the primary DNS, see the section “Adding a Primary DNS for FQDN Name Resolution.”
 - **Port***—Port on which the LDAP server is running. Default value: 389.
 - **Time-out***—Number of seconds the system will wait for a response from the LDAP server.
 - **Base DN**—Base, or node where the LDAP search should start.
 - **Type**—Type of LDAP server. Possible values: Active Directory (AD) and Novell Directory Service (NDS).
 - **Administrative Bind DN**—Full distinguished name that is used to bind to the LDAP server.
 - **Administrative Password**—Password that is used to bind to the LDAP server.
 - **Validate LDAP Certificate**—Check this option to validate the certificate received from LDAP server.
 - **LDAP Host Name**—Hostname for the LDAP server. If the `validateServerCert` parameter is enabled, this parameter specifies the host name on the certificate from the LDAP server. A host-name mismatch causes a connection failure.
 - **Server Logon Name Attribute**—Name attribute used by the system to query the external LDAP server or an Active Directory.

- Search Filter—String to be combined with the default LDAP user search string to form the value. For example, `vpnallowed=true` with `ldaploginname samaccount` and the user-supplied username `bob` would yield an LDAP search string of: `(&(vpnallowed=true)(samaccount=bob))`.
- Group Attribute—Attribute name for group extraction from the LDAP server.
- Sub Attribute Name—Subattribute name for group extraction from the LDAP server.
- Security Type—Type of encryption for communication between the appliance and the authentication server. Possible values:
 - PLAINTEXT: No encryption required.
 - TLS: Communicate using TLS protocol.
 - SSL: Communicate using SSL Protocol
- Default Authentication Group—Default group that is chosen when the authentication succeeds in addition to extracted groups.
- Referrals—Enable following of LDAP referrals received from LDAP server.
- Maximum LDAP Referrals—Maximum number of LDAP referrals to follow.
- Enable Change Password—Allow user to modify the password if the password expires. You can change the password only when the Security Type configured is TLS or SSL.
- Enable Nested Group Extraction—Enable Nested Group extraction feature.
- Maximum Nesting Level—Number of levels at which group extraction is allowed.
- Group Name Identifier—Name that uniquely identifies a group in LDAP server.
- Group Search Attribute—LDAP group search attribute. Used to determine to which groups a group belongs.
- Group Search Subattribute—LDAP group search subattribute. Used to determine to which groups a group belongs.
- Group Search Filter—String to be combined with the default LDAP group search string to form the search value.

4. Click Create, and then click Close.

SSH public key authentication support for LDAP users

The SDX appliance can now authenticate the LDAP users through SSH public key authentication for logon. The list of public keys is stored on the user object in the LDAP server. During authentication, SSH extracts the SSH public keys from the LDAP server. The logon succeeds if any of the retrieved public key works with SSH.

The same attribute name of the extracted public key must be present in both LDAP server and in the NetScaler SDX appliance.

Important:

For key-based authentication, you must specify a location of the public keys by setting the value of `*Authorizedkeysfile*` in `*/etc/sshd_config*` file in the following aspect:

```
AuthorizedKeysFile .ssh/authorized_keys
```

System User. You can specify the location of public keys for any system user by setting the value of `Authorizedkeysfile` in `/etc/sshd_config` file.

LDAP Users. The retrieved public key is stored in the `*/var/pubkey/\<user_name\\>/tmp_authorized_keys-\<pid\\>`. * The `\<pid\\>` is the unique number added to differentiate between concurrent SSH requests from the same user. This is the temporary location to hold the public key during the authentication process. The public key is removed from the system once authentication is complete.

To login with the user, run the following command from the shell prompt:

```
$ ssh -i \<private key\\> \<username\\>@\<IPAddress\\>
```

To configure LDAP server by using the GUI:

1. Navigate to **System > Authentication > LDAP**.
2. On the LDAP page, click ****Servers**** tab.
3. Click any of the available LDAP servers.
4. On the **Configure Authentication LDAP Server** page, check the **Authentication** checkbox for authentication purpose.

Name
ldap-ssh

Server Name / IP Address*
10.102.166.70

Security Type*
TLS

Port*
389

Server Type*
AD

Time-out (seconds)*
3

Validate LDAP Certificate

LDAP Host Name

Authentication

SSH Public key*
sshPublicKeys

Note:

Uncheck the Authentication check box to use “sshPublicKeys” for authentication of LDAP users.

Adding a Primary DNS for FQDN Name Resolution

If you define a RADIUS or an LDAP server by using the FQDN of the server rather than its IP address, you must manually set the primary DNS to resolve the server name, either by using the GUI or CLI.

To set the primary DNS by using the GUI, go to **System > Network Configuration > DNS**.

To set the primary DNS by using the CLI, follow these steps.

1. Open a Secure Shell (SSH) console.
2. Log on to the NetScaler SDX appliance by using the nsroot/nsroot credentials.
3. Run the networkconfig command.
4. Select the appropriate menu and update the DNS IPv4 Address , and save the changes.

If you run the networkconfig command again, you'll see the updated DNS address.

Adding a TACACS Server

To configure TACACS authentication, specify the authentication type as TACACS, and configure the TACACS authentication server.

To add a TACACS server

1. On the **Configuration** tab, under **System**, expand **Authentication**, and then click **TACACS**.
2. In the details pane, click **Add**.
3. In the **Create TACACS Server** dialogue box, type or select values for the parameters:
 - Name—Name of the TACAS server
 - IP Address—IP address of the TACACS server
 - Port—Port on which the TACACS Server is running. Default value: 49
 - Time-out—Maximum number of seconds the system will wait for a response from the TACACS server
 - TACACS Key —Key shared between the client and the server. This information is required for the system to communicate with the TACACS server
 - Accounting—Enables Management Service to log audit information with TACACAS server.
 - Default Authentication Group—Default group that is chosen when the authentication succeeds in addition to extracted groups.
4. Click **Create**, and then click **Close**.

Configuring Link Aggregation from the Management Service

September 27, 2025

Link aggregation combines multiple Ethernet links into a single high-speed link. Configuring link aggregation increases the capacity and availability of the communication channel between the NetScaler SDX appliance and other connected devices. An aggregated link is also referred to as a “channel.”

When a network interface is bound to a channel, the channel parameters have precedence over the network interface parameters. (That is, the network interface parameters are ignored.) A network interface can be bound only to one channel.

When a network interface is bound to a channel, it drops its VLAN configuration. The interface is removed from the VLAN that it originally belonged to and added to the default VLAN. However, you can bind the channel back to the old VLAN, or to a new one. For example, if you bind network interfaces 1/2 and 1/3 to a VLAN with ID 2 (VLAN 2), and then bind them to channel LA/1, the network interfaces are moved to the default VLAN, but you can bind the channel to VLAN 2.

Note:

- An interface must be part of only one channel.
- A minimum of two interfaces are required to configure a channel.
- The interfaces that form part of a channel are not listed in the Network Settings view when you add or modify a Citrix® ADC instance. Instead of the interfaces, the channels are listed.

If you configure a channel by using three interfaces that are assigned to one instance, and a second instance uses some of these interfaces, the Management Service shuts down the second instance, modifies the network settings, and restarts the instance. For example, assume two instances, Instance1 and Instance2. When these instances are provisioned, interfaces 10/1, 10/2, and 10/3 are assigned to Instance1, and interfaces 10/1 and 10/2 are assigned to Instance2. If an LA channel is created with interfaces 10/1, 10/2, and 10/3, instance1 is not restarted. However, the Management Service shuts down Instance2, assigns interface 10/3 to Instance2, and then restarts Instance2.

If you remove an interface from an LA channel, the changes are stored in the database, and the interface appears in the Network Settings view when you add or modify an instance. Before you delete the interface, only the channel that the interface is a part of is listed.

Configuring a channel from the Management Service

September 27, 2025

You can configure a channel manually, or you can use the Link Aggregation Control Protocol (LACP). You cannot apply LACP to a manually configured channel, nor can you manually configure a channel created by LACP. Configure a channel from the Management Service. Then, select the channel at the time of provisioning or modifying a Citrix® ADC instance.

An LA channel is a logical entity to provide for link redundancy and bandwidth aggregation. Interfaces that are part of a channel cannot be assigned separate IP addresses.

Note: A NetScaler SDX appliance supports link aggregation but does not support link redundancy.

To configure a channel from the Management Service

1. On the **Configuration** tab, navigate to **System > Channels**.
2. In the details pane, click **Add**.
3. In the **Add Channel** dialog box, set the following parameters:
 - Channel ID—ID for the LA channel to be created. Specify an LA channel in LA/x notation, where x can range from 1 to a number equal to one-half the number of interfaces. Cannot be changed after the LA channel is created.
 - Type—Type of channel. Possible values:
 - Static—configured only on the data interfaces.
 - Active-Active—configured only on the management interfaces 0/x.
 - Active-Passive—configured only on the management interfaces 0/x.
 - LACP—configured on data interfaces and the management interfaces 0/x.
 - Throughput (Applies only to a static channel and LACP)—Low threshold value for the throughput of the LA channel, in Mbps. In an HA configuration, failover is triggered if the LA channel has HA MON enabled and the throughput is below the specified threshold.
 - Bandwidth High (Applies only to a static channel and LACP)—High threshold value for the bandwidth usage of the LA channel, in Mbps. The appliance generates an SNMP trap message when the bandwidth usage of the LA channel is equal to or greater than the specified high threshold value.
 - Bandwidth Normal (Applies only to a static channel and LACP)—Normal threshold value for the bandwidth usage of the LA channel, in Mbps. When the bandwidth usage of the LA channel becomes equal to or less than the specified normal threshold after exceeding the high threshold, the NetScaler SDX appliance generates an SNMP trap message to indicate that bandwidth usage has returned to normal.
4. On the **Interfaces** tab, add the interfaces that you want to include in this channel.
5. On the **Settings** tab, set the following parameters:
 - Channel State (Applies only to a static channel)—Enable or disable the LA channel.

- LACP Time (Applies only to LACP)—Time after which a link is not aggregated if the link does not receive an LACPDU. The value must match on all the ports participating in link aggregation on the SDX appliance and the partner node.
- HA Monitoring—In a High Availability (HA) configuration, monitor the channel for failure events. Failure of any LA channel that has HA MON enabled triggers HA failover.
- Tag All—Add a four-byte 802.1q tag to every packet sent on this channel. The ON setting applies tags for all VLANs that are bound to this channel. OFF applies the tag for all VLANs other than the native VLAN.
- Alias Name—Alias name for the LA channel. Used only to enhance readability. To perform any operations, you have to specify the LA channel ID.

6. Click **Create**, and then click **Close**.

Notes

- You cannot create a management LA if both 0/1 and 0/2 interfaces are part of a VPX instance, and that instance is part of a cluster.
- You cannot delete a management LA if it is part of a VPX instance, and that instance is part of a cluster.

Access Control Lists

September 27, 2025

An access control list (ACL) is a set of conditions that you can apply to a network appliance to filter IP traffic and secure your appliance from unauthorized access.

You can configure an ACL on your NetScaler SDX Management Service GUI to limit and control access to the appliance.

Note:

ACLs on SDX appliances are supported from release 12.0 57.19 onwards.

This topic includes the following sections:

- Usage Guidelines
- How to Configure ACLs
- Additional Actions for ACL Rules
- Troubleshooting

Usage Guidelines

Keep the following points in mind while creating ACLs on your appliance:

- When you upgrade the SDX appliance to release 12.0 57.19, the ACL feature is disabled by default.
- SDX administrators can control only inbound packets through ACL on the SDX appliance.
- If you use Citrix® Application Delivery Management to manage your SDX appliance, you must create appropriate ACL rules to allow communication between MAS and SDX Management Service.
- For any other configurations on the SDX appliance such as provisioning or deleting VPXs, adding/deleting external servers, SNMP management, and so on, do not require any changes in the existing ACL configuration. Communication with these entities are taken care of by the Management Service.

How to Configure an ACL

Configuring an ACL involves the following steps:

- Enable the ACL feature
- Create an ACL rule
- Enable the ACL rule

Note:

You can create ACL rules without enabling the ACL feature. However, if the feature is not enabled, you cannot enable an ACL rule after you've created it.

To enable the ACL feature

1. To enable the ACL feature, log on to the SDX Management Service GUI and navigate to **Configuration > System > ACL**.
2. By using the toggle button, turn on the ACL feature.

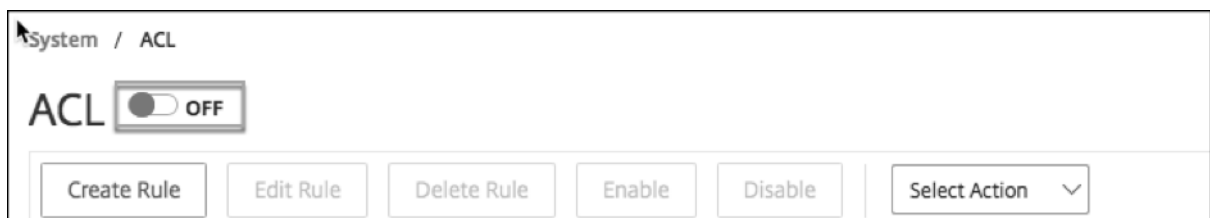

To create an ACL rule

1. On the ACL page, click **Create Rule**.
2. The Create Rule window opens. Add the details listed in the following table.

Property	Description
Name	Add a name.
Protocol	Select a protocol from the menu. By default, TCP is selected. You can select ANY to allow all protocols.
Source IP Address/Subnet	Specify the source IP address or source subnet to which the rule applies. Select ANY if the rule needs to be applied to all incoming traffic.
Destination IP	The SDX Management Service IP address is autopopulated as the destination IP. This field cannot be edited.
Destination port	Specify the destination port to which the rule applies. Select ANY if the rule applies to all destination ports.
Action	Select the action for rule, which is Allow or Deny.
Priority	Assign priority to specify the order in which the rule is to be evaluated. Priority numbers determine the order in which ACL rules are matched against an incoming packet. A lower priority number has a higher priority. For example, priority number 1 has a higher priority than priority number 2. If none of the rules match with the incoming packet, then the packet is blocked.

3. Click **OK** to create the rule.

Figure: An example of an ACL rule

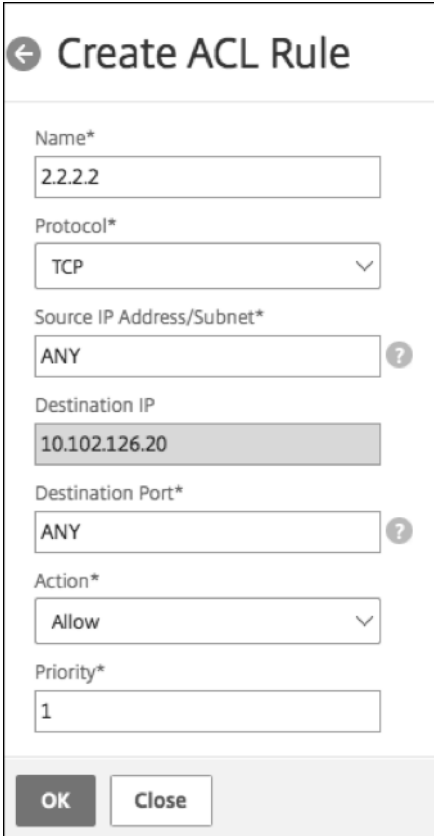

← Create ACL Rule

Name*
2.2.2.2

Protocol*
TCP

Source IP Address/Subnet*
ANY ?

Destination IP
10.102.126.20

Destination Port*
ANY ?

Action*
Allow

Priority*
1

OK Close

After the rule is created, it is in disabled state. To make the rule effective, you must enable the rule.

Note:

To enable a rule, the ACL feature should be enabled. If the feature is disabled, and you attempt to enable an ACL rule, a message “ACL is not running” appears.

To enable an ACL rule

1. Hover your mouse over the rule that you want to enable and click the circle with three dots.
2. From the menu, select **Enable**.
3. Alternatively, select the radio button for that rule and click the **Enable** tab.
4. At the prompt, click **Yes** to confirm.

Additional Actions for ACL Rules

You can apply the following actions to ACL rules:

1. Disable an ACL rule

2. Edit an ACL rule
3. Delete an ACL rule
4. Renumber the priority of ACL rules

To disable an ACL rule

1. Hover the mouse over the rule that you want to disable and select the circle with three dots.
2. Click **Disable** from the list.
3. Alternatively, select the radio button for that rule and click the **Disable** tab.
4. Click **Yes** to confirm.

Note:

When you disable a rule, the rule no longer applies to incoming traffic; however, the rule configuration remains under ACL settings.

To edit an ACL rule

1. Hover the mouse over the rule that you want to edit and select the circle with three dots.
2. Click **Edit Rule** from the list. The **Modify Rule** window opens.
3. Alternatively, select the radio button for that rule and click the **Edit Rule** tab. The **Modify Rule** window opens
4. Make the edits and click **OK**.

Note:

You can edit a rule in both enabled and disabled state. If you edit a rule that is already enabled, the edits get applied immediately. For a rule in disabled state, the edits get applied when you enable the rule.

To delete an ACL rule

1. Ensure that the rule is in disabled state.
2. Hover the mouse over the rule that you want to delete and select the circle with three dots. Click **Delete Rule** from the list.
3. Alternatively, select the radio button for that rule and click the **Delete Rule** tab.
4. Click **Yes** to confirm.

Note:

You cannot delete a rule in enabled state.

To renumber priorities of ACL rules

1. Hover the mouse over the rule that you want to renumber the priorities for and select the circle with three dots. Click **Renumber Priority(s)** from the list.
2. Alternatively, select the radio button for that rule and click the **Select Action** tab.
3. Select **Renumber Priority(s)**.
4. The SDX Management Service automatically assigns new priority numbers, which are multiples of 10, to all the existing rules.
5. Edit the rules to assign priority numbers according to your requirement. See the “To edit an ACL rule” section for more information about how to edit a rule.

Figure. An example of existing priority numbers

<input type="checkbox"/>	Priority ↑	Name	Source IP Address/Subnet
<input type="checkbox"/>	1	2.2.2.2	ANY
<input type="checkbox"/>	2	test1	1.1.1.1
<input type="checkbox"/>	3	test2	ANY

Figure. An example of priority numbers in multiples of 10, after priorities are renumbered

<input type="checkbox"/>	Priority ↑	Name	Source IP Address/Subnet
<input type="checkbox"/>	10	2.2.2.2	ANY
<input type="checkbox"/>	20	test1	1.1.1.1
<input type="checkbox"/>	30	test2	ANY

Troubleshooting

If ACL rules are improperly set up, all user accounts can be denied access. If you inadvertently lose all network access to the SDX Management Service because of improper ACL setup, follow these steps to gain access.

1. Log on to the Citrix Hypervisor management IP address by using SSH and your “root” account.
2. Log on to the console of the Management Service VM by using nsroot privileges.

3. Run the command “pfctl -d”.
4. Log on to the Management Service through GUI and reconfigure the ACL accordingly.

Set up a cluster of Citrix® ADC instances

September 27, 2025

After provisioning Citrix ADC instances on one or more SDX appliances, you can create a cluster of Citrix ADC instances.

Citrix recommends that you perform the cluster configuration from the Management Service. When you perform the cluster configuration from a VPX instance, the Management Service learns about the configuration during auto-discovery every 30 minutes. In the worst case, the clustering information is not discovered for 30 minutes. While the cluster might work properly, some essential validation checks for cluster dependencies are missed. These checks are performed by the Management Service before configuring the cluster on ADC instances. Therefore, you must perform any cluster configuration from the Management Service.

Note:

- To set up a cluster, you must understand Citrix ADC clustering. For more information, see [Clustering](#).
- For clusters that have Citrix ADC instances across SDX appliances, Citrix recommends that you use Citrix ADC instances from three SDX appliances. This configuration ensures that the cluster criteria of a minimum of $(n/2 + 1)$ nodes is always satisfied.

Figure 1. Cluster of SDX Citrix ADC instances

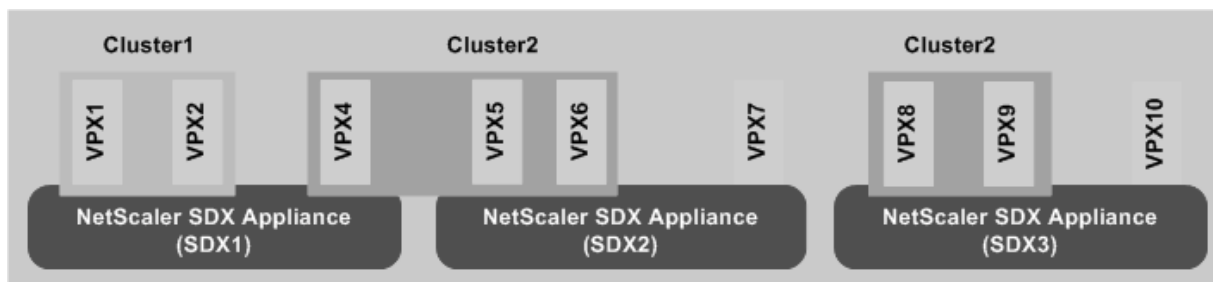

The preceding figure shows three SDX appliances, SDX1, SDX2, and SDX3, on the same subnet. The Citrix ADC instances on these appliances are used to form two clusters: Cluster1 and Cluster2.

- Cluster1 includes two instances on SDX1.
- Cluster2 includes one instance on SDX1, two instances on SDX2, and another two instances on SDX3.

Points to remember

- It is recommended to use 6 GB RAM for each node of the cluster.
- NetScaler VPX instances hosted on NetScaler SDX™ appliance must be provisioned with a dedicated core.
- All nodes of a cluster must be of the same type. You cannot form a cluster of hardware and virtual appliances, nor a cluster of VPX Citrix ADC instances and SDX Citrix ADC instances.
- The Citrix ADC instances must be of the same version, which must be version 10.1 or later.
- The Citrix ADC instances must all have the same feature license.
- No configurations can be updated on individual Citrix ADC instances after they are added to the cluster. All changes must be performed through the cluster IP address.
- The Citrix ADC instances must all have the same resources (memory, CPU, interfaces, and so on).

Set up a cluster on an SDX appliance

1. Log on to the SDX appliance.
2. On the **Configuration** tab, navigate to **Citrix ADC**, and then click **Clusters**.
3. Create the cluster:
 - a) Click **Create Cluster**.
 - b) In the **Create Cluster** dialog box, set the parameters required for the cluster. For a description of a parameter, hover the mouse cursor over the corresponding field.
 - c) Click **Next** to view the configuration summary.
 - d) Click **Finish** to create the cluster.

Note: When an ADC instance has L2 VLAN configured, and if that node is added to the cluster, then the `add vlan` command is saved with the `sdxvlan` parameter set to Yes. This parameter is an internal argument and is used to avoid loss of connectivity during SDX cluster formation.
4. Add nodes to the cluster:
 - a) Click **Add Node**.
 - b) In the **Add Node** dialog box, configure the parameters required for adding a cluster node. For a description of a parameter, hover the mouse cursor over the corresponding field.
 - c) Click **Next** to view the configuration summary.
 - d) Click **Finish** to add the node to the cluster.
 - e) Repeat steps a through d to add another node to the cluster.

After creating the cluster, you must configure it by accessing it through the cluster IP address.

Note: To get an updated list of Citrix ADC clusters, each of which has at least one Citrix ADC instance of the SDX appliance, use the Rediscover option.

To add a Citrix ADC instance that exists on one SDX appliance to a cluster configured on another SDX appliance

1. Log on to the SDX appliance from which you want to add the Citrix ADC instance.
2. On the **Configuration** tab, navigate to **Citrix ADC**, and then click **Clusters**.
3. Click **Add Node**.
4. In the **Add Node** dialog box, configure the parameters required for adding a cluster node. For a description of a parameter, hover the mouse cursor over the corresponding field.

Note: Make sure the values of the cluster IP address and cluster IP Password parameters are for the cluster to which you want to add the node.

5. Click **Next** to view the configuration summary.
6. Click **Finish** to add the node to the cluster.

Configuring Cluster Link Aggregation

September 27, 2025

Cluster link aggregation, as the name suggests, combines a group of cluster-node interfaces into a channel. It is an extension of Citrix ADC link aggregation (LA). The only difference is that, while link aggregation requires the interfaces to be on the same device, in cluster link aggregation, the interfaces are on different nodes of the cluster. For more information about link aggregation, see [Configuring Link Aggregation](#).

For example, consider a six-node cluster, across two SDX appliances, in which all six nodes are connected to an upstream switch. A cluster LA channel (CLA/1) is formed by binding interfaces 0/1/2, 1/1/3, 2/1/4, 3/1/2, 4/1/3, and 5/1/4.

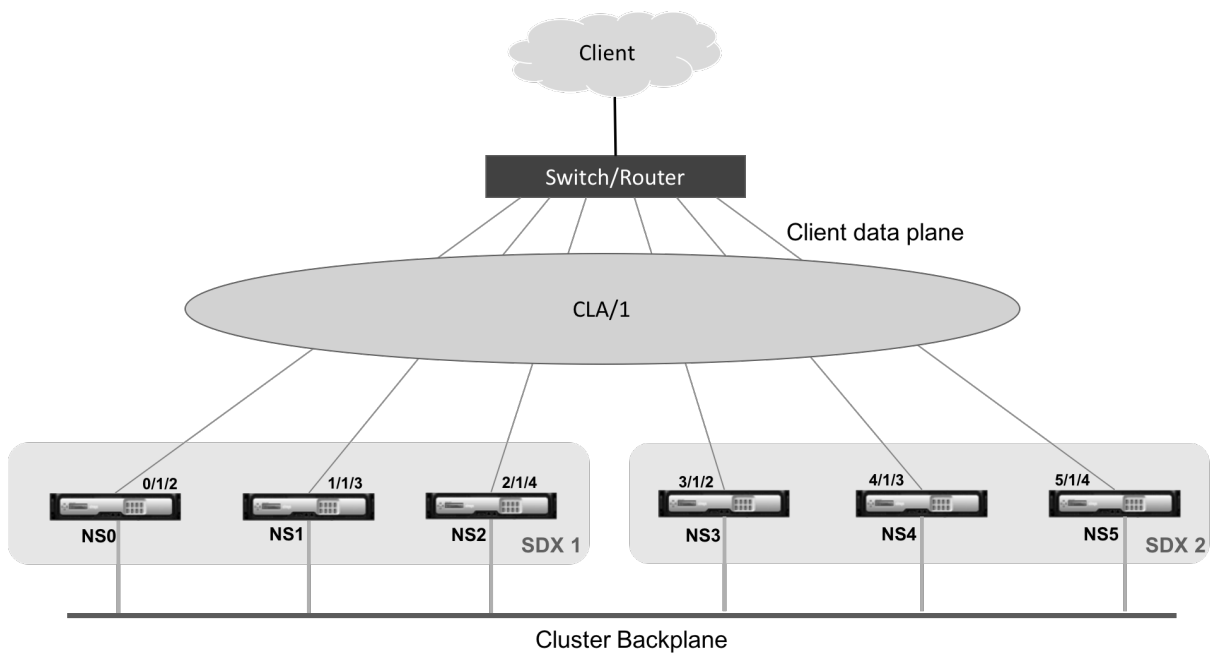

A cluster LA channel has the following attributes:

- Each channel has a unique MAC address agreed upon by cluster nodes.
- The channel can bind both local and remote SDX nodes' interfaces.
- A maximum of four cluster LA channels are supported in a cluster.
- A maximum of 16 interfaces can be bound to each cluster LA channel.
- Backplane interfaces cannot be part of a cluster LA channel.
- When an interface is bound to a cluster LA channel, the channel parameters take precedence over the network interface parameters.
- A network interface can be bound to only one channel.
- Management access to a cluster node must not be configured on a cluster LA channel (for example, CLA/1) or its member interfaces. When the node is INACTIVE, the corresponding cluster LA interface is marked as POWER OFF, which causes it to lose management access.

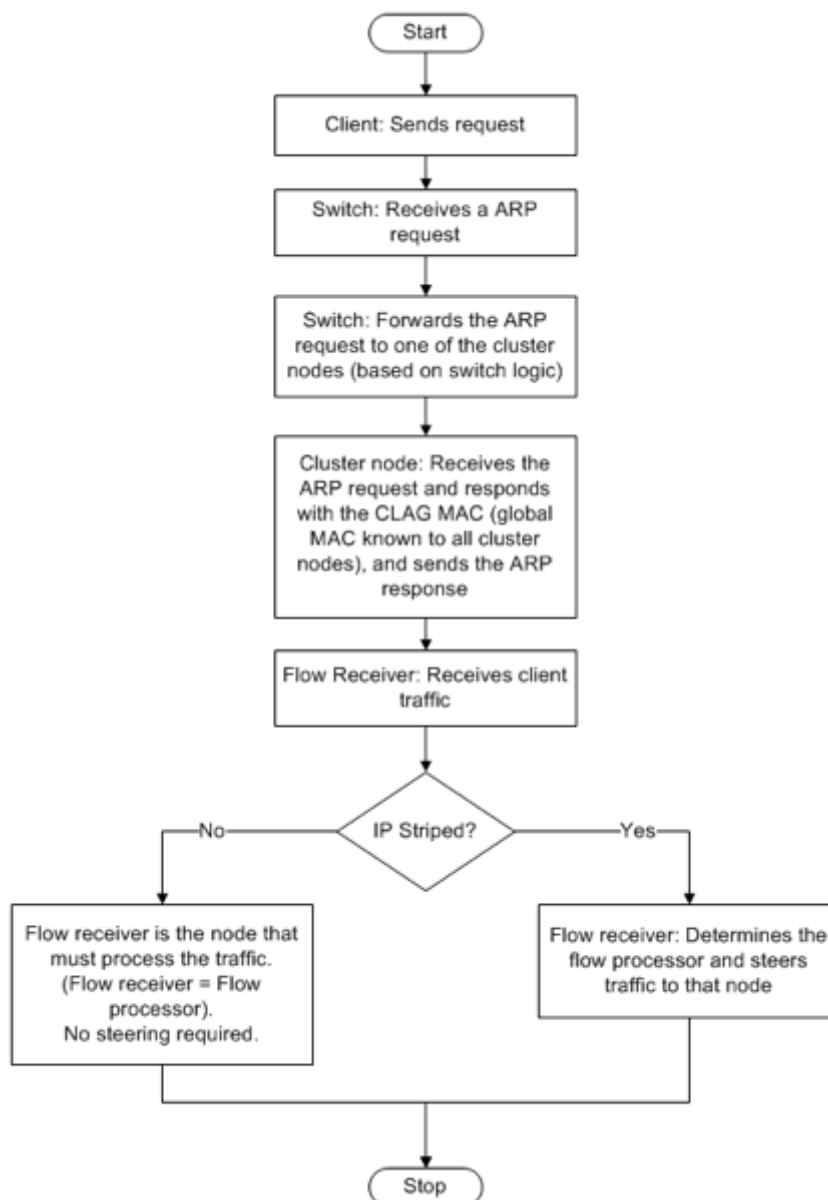

You must implement similar configurations on the cluster IP address and on the external connecting device. If possible, configure the upstream switch to distribute traffic on the basis of IP address or port instead of MAC address.

Points to remember:

- Enable LACP (by specifying the LACP mode as either ACTIVE or PASSIVE).
Note: Make sure the LACP mode is not set as PASSIVE on both the Citrix® ADC cluster and the external connecting device.
- For creating a cluster LA channel, the LACP key can have a value from 5 through 8. These LACP Keys are mapped to CLA/1, CLA/2, CLA/3, and CLA/4.

- On the SDX appliance, the cluster link aggregation group (CLAG) member interfaces cannot be shared with other virtual machines.
- On the upstream switch, set LACP timeout to “short” to avoid long-duration traffic black holes on cluster nodes when the upstream switch is not notified of power down of the CLAG and its member interfaces until after LACP timeout.

Prerequisites:

Make sure that you have created a cluster of Citrix ADC instances. The nodes of the cluster can be Citrix ADC instances on the same SDX appliance or on other SDX appliances that are available on the same subnet.

To configure a cluster LA channel by using the Management Service:

1. Log on to the SDX appliance.
2. On the **Configuration** tab, navigate to **Citrix ADC**, and then click **Clusters**.
3. On the **Cluster Instances** page, select the cluster and click **CLAG**.

NetScaler / Cluster Instances

Cluster Instances

Create Cluster	Add Node	Remove Cluster	Change Admin Profile	Show Cluster Nodes	Add Node Group	Rediscover		
CLAG								
<input type="checkbox"/>	Cluster IP Address	Instance Id	No of Nodes	Admin State	Operational State	Status	Rx (Mbps)	Tx (Mbps)
<input checked="" type="checkbox"/>	10.217.205.87	2	1	● ENABLED	● ENABLED	● UP	0	0

4. In the **Create CLAG** dialog box, do the following:
 - a) In the **Channel ID** drop-down list, select the cluster LA channel ID.
 - b) In the **Interfaces** section, from the **Available** selection box, select the interfaces and click **+**.
 - c) The selected interfaces are displayed under **Configured** selection box.
5. In the **Setting** section, do the following:
 - a) In the **Alias** field, enter an alternative name for the cluster LA channel.
 - b) In the **LACP Timeout** field, select one of the following values to define the interval after which a link is not aggregated, if the link does not receive an LACPDU.

The value must match on all the ports participating in link aggregation on the SDX appliance and the partner node:

 - **Long** –30 seconds
 - **Short** –1 second

- c) For High Availability (HA) configuration, select the **HA Monitoring** check box to monitor the channel for failure events. Failure of any LA channel that has HA MON enabled triggers HA failover.
- d) Select **Tag All** to add a four-byte 802.1q tag to every packet sent on this channel. The **ON** setting applies tags for all VLANs that are bound to this channel. OFF applies the tag to all VLANs other than the native VLAN.
6. Click **Create** to configure a CLAG for one of the SDX appliances.

The screenshot shows the 'Create CLAG' configuration page in the Citrix NetScaler SDX (8400) interface. The page has a navigation bar with 'Dashboard', 'Configuration', 'Documentation', and 'Downloads'. The main heading is 'Create CLAG'. Below the heading, there is a 'Channel ID*' dropdown menu set to 'CLA/2'. Under 'Interfaces', there are two panels: 'Available (3)' with a 'Select All' button and three items (1/2, 1/3, 1/6) each with a '+' button, and 'Configured (0)' with a 'Remove All' button and 'No items' listed. Below the interfaces is a 'Settings' section with an 'Alias' text box, 'LACP Timeout' radio buttons for 'Long' (selected) and 'Short', and checkboxes for 'HA Monitoring' (checked) and 'Tag All' (unchecked). At the bottom are 'Create' and 'Close' buttons.

7. In the **Confirm** dialog box, click **Yes** to refresh the CLAG settings in the other SDX appliances.

Notes:

- If you select **No**, the CLAG is not configured.
- Manually refresh the CLAG settings in the other SDX appliances.
- The MTU settings must be the same on both of the SDX appliances. The MTU settings must be changed manually on either of the SDX appliances.

8. To change the MTU settings in the **CLAGs** dialog box, do the following:

- a) Select **CLA/1** and click **Edit**.
 - b) In the **Configure CLAG** dialog box, set the MTU manually in the **MTU** field and click **OK**.
9. In the **Confirm** dialog box, click **Yes**.

Configuring SSL Ciphers to Securely Access the Management Service

September 27, 2025

You can select SSL cipher suites from a list of SSL ciphers supported by NetScaler SDX appliances, and bind any combination of the SSL ciphers to access the SDX Management Service securely through HTTPS. An SDX appliance provides 37 predefined cipher groups, which are combinations of similar ciphers, and you can create custom cipher groups from the list of supported SSL ciphers.

Limitations

- Binding ciphers with key exchange = “DH” or “ECC-DHE” is not supported.
- Binding the ciphers with Authentication = “DSS” is not supported.
- Binding ciphers that are not part of the supported SSL ciphers list, or including these ciphers in a custom cipher group, is not supported.

Supported SSL Ciphers

The following table lists the supported SSL ciphers.

Cipher Name	Openssl CipherName	Hex Code	Protocol	KeyExchange	Auth	MAC
TLS1-AES-256-CBC-SHA	AES256-SHA	0x0035	SSLv3	RSA	RSA	AES(256)
TLS1-AES-128-CBC-SHA	AES128-SHA	0x002F	SSLv3	RSA	RSA	AES(128)
TLS1.2-AES-256-SHA256	AES256-SHA256	0x003D	TLSv1.2	RSA	RSA	AES(256)

Citrix						
Cipher Name	Openssl CipherName	Hex Code	Protocol	KeyExchange	Auth	MAC
TLS1.2-AES-128-SHA256	AES128-SHA256	0x003C	TLSv1.2	RSA	RSA	AES(128)
TLS1.2-AES256-GCM-SHA384	AES256-GCM-SHA384	0x009D	TLSv1.2	RSA	RSA	AES-GCM(256)
TLS1.2-AES128-GCM-SHA256	AES128-GCM-SHA256	0x009C	TLSv1.2	RSA	RSA	AES-GCM(128)
TLS1-ECDHE-RSA-AES256-SHA	ECDHE-RSA-AES256-SHA	0xC014	SSLv3	ECC-DHE	RSA	AES(256)
TLS1-ECDHE-RSA-AES128-SHA	ECDHE-RSA-AES128-SHA	0xC013	SSLv3	ECC-DHE	RSA	AES(128)
TLS1.2-ECDHE-RSA-AES-256-SHA384	ECDHE-RSA-AES256-SHA384	0xC028	TLSv1.2	ECC-DHE	RSA	AES(256)
TLS1.2-ECDHE-RSA-AES-128-SHA256	ECDHE-RSA-AES128-SHA256	0xC027	TLSv1.2	ECC-DHE	RSA	AES(128)
TLS1.2-ECDHE-RSA-AES256-GCM-SHA384	ECDHE-RSA-AES256-GCM-SHA384	0xC030	TLSv1.2	ECC-DHE	RSA	AES-GCM(256)
TLS1.2-ECDHE-RSA-AES128-GCM-SHA256	ECDHE-RSA-AES128-GCM-SHA256	0xC02F	TLSv1.2	ECC-DHE	RSA	AES-GCM(128)

Citrix						
Cipher Name	Openssl CipherName	Hex Code	Protocol	KeyExchange	Auth	MAC
TLS1.2-DHE-RSA-AES-256-SHA256	DHE-RSA-AES256-SHA256	0x006B	TLSv1.2	DH	RSA	AES(256)
TLS1.2-DHE-RSA-AES-128-SHA256	DHE-RSA-AES128-SHA256	0x0067	TLSv1.2	DH	RSA	AES(128)
TLS1.2-DHE-RSA-AES256-GCM-SHA384	DHE-RSA-AES256-GCM-SHA384	0x009F	TLSv1.2	DH	RSA	AES-GCM(256)
TLS1.2-DHE-RSA-AES128-GCM-SHA256	DHE-RSA-AES128-GCM-SHA256	0x009E	TLSv1.2	DH	RSA	AES-GCM(128)
TLS1-DHE-RSA-AES-256-CBC-SHA	DHE-RSA-AES256-SHA	0x0039	SSLv3	DH	RSA	AES(256)
TLS1-DHE-RSA-AES-128-CBC-SHA	DHE-RSA-AES128-SHA	0x0033	SSLv3	DH	RSA	AES(128)
TLS1-DHE-DSS-AES-256-CBC-SHA	DHE-DSS-AES256-SHA	0x0038	SSLv3	DH	DSS	AES(256)
TLS1-DHE-DSS-AES-128-CBC-SHA	DHE-DSS-AES128-SHA	0x0032	SSLv3	DH	DSS	AES(128)

Citrix						
Cipher Name	Openssl CipherName	Hex Code	Protocol	KeyExchange	Auth	MAC
TLS1-ECDHE-RSA-DES-CBC3-SHA	ECDHE-RSA-DES-CBC3-SHA	0xC012	SSLv3	ECC-DHE	RSA	3DES(168)
SSL3-EDH-RSA-DES-CBC3-SHA	EDH-RSA-DES-CBC3-SHA	0x0016	SSLv3	DH	RSA	3DES(168)
SSL3-EDH-DSS-DES-CBC3-SHA	EDH-DSS-DES-CBC3-SHA	0x0013	SSLv3	DH	DSS	3DES(168)
TLS1-ECDHE-RSA-RC4-SHA	ECDHE-RSA-RC4-SHA	0xC011	SSLv3	ECC-DHE	RSA	RC4(128)
SSL3-DES-CBC3-SHA	DES-CBC3-SHA	0x000A	SSLv3	RSA	RSA	3DES(168)
SSL3-RC4-SHA	RC4-SHA	0x0005	SSLv3	RSA	RSA	RC4(128)
SSL3-RC4-MD5	RC4-MD5	0x0004	SSLv3	RSA	RSA	RC4(128)
SSL3-DES-CBC-SHA	DES-CBC-SHA	0x0009	SSLv3	RSA	RSA	DES(56)
SSL3-EXP-RC4-MD5	EXP-RC4-MD5	0x0003	SSLv3	RSA(512)	RSA	RC4(40)
SSL3-EXP-DES-CBC-SHA	EXP-DES-CBC-SHA	0x0008	SSLv3	RSA(512)	RSA	DES(40)
SSL3-EXP-RC2-CBC-MD5	EXP-RC2-CBC-MD5	0x0006	SSLv3	RSA(512)	RSA	RC2(40)
SSL2-DES-CBC-MD5	DHE-DSS-AES128-SHA256	0x0040	SSLv2	RSA	RSA	DES(56)
SSL3-EDH-DSS-DES-CBC-SHA	EDH-DSS-DES-CBC-SHA	0x0012	SSLv3	DH	DSS	DES(56)

Citrix						
Cipher Name	Openssl CipherName	Hex Code	Protocol	KeyExchange	Auth	MAC
SSL3-EXP-EDH-DSS-DES-CBC-SHA	EXP-EDH-DSS-DES-CBC-SHA	0x0011	SSLv3	DH(512)	DSS	DES(40)
SSL3-EDH-RSA-DES-CBC-SHA	EDH-RSA-DES-CBC-SHA	0x0015	SSLv3	DH	RSA	DES(56)
SSL3-EXP-EDH-RSA-DES-CBC-SHA	EXP-EDH-RSA-DES-CBC-SHA	0x0014	SSLv3	DH(512)	RSA	DES(40)
SSL3-ADH-RC4-MD5	ADH-RC4-MD5	0x0018	SSLv3	DH	None	RC4(128)
SSL3-ADH-DES-CBC3-SHA	ADH-DES-CBC3-SHA	0x001B	SSLv3	DH	None	3DES(168)
SSL3-ADH-DES-CBC-SHA	ADH-DES-CBC-SHA	0x001A	SSLv3	DH	None	DES(56)
TLS1-ADH-AES-128-CBC-SHA	ADH-AES128-SHA	0x0034	SSLv3	DH	None	AES(128)
TLS1-ADH-AES-256-CBC-SHA	ADH-AES256-SHA	0x003A	SSLv3	DH	None	AES(256)
SSL3-EXP-ADH-RC4-MD5	EXP-ADH-RC4-MD5	0x0017	SSLv3	DH(512)	None	RC4(40)
SSL3-EXP-ADH-DES-CBC-SHA	EXP-ADH-DES-CBC-SHA	0x0019	SSLv3	DH(512)	None	DES(40)
SSL3-NULL-MD5	NULL-MD5	0x0001	SSLv3	RSA	RSA	None
SSL3-NULL-SHA	NULL-SHA	0x0002	SSLv3	RSA	RSA	None

Predefined Cipher Groups

The following table lists the predefined cipher groups provided by the SDX appliance.

Cipher Group Name	Description
ALL	All ciphers supported by the SDX appliance, excluding NULL ciphers
DEFAULT	Default cipher list with encryption strength >= 128bit
kRSA	Ciphers with Key-ex algo as RSA
kEDH	Ciphers with Key-ex algo as Ephemeral-DH
DH	Ciphers with Key-ex algo as DH
EDH	Ciphers with Key-ex/Auth algo as DH
aRSA	Ciphers with Auth algo as RSA
aDSS	Ciphers with Auth algo as DSS
aNULL	Ciphers with Auth algo as NULL
DSS	Ciphers with Auth algo as DSS
DES	Ciphers with Enc algo as DES
3DES	Ciphers with Enc algo as 3DES
RC4	Ciphers with Enc algo as RC4
RC2	Ciphers with Enc algo as RC2
NULL	Ciphers with Enc algo as NULL
MD5	Ciphers with MAC algo as MD5
SHA1	Ciphers with MAC algo as SHA-1
SHA	Ciphers with MAC algo as SHA
NULL	Ciphers with Enc algo as NULL
RSA	Ciphers with Key-ex/Auth algo as RSA
ADH	Ciphers with Key-ex algo as DH and Auth algo as NULL
SSLv2	SSLv2 protocol ciphers
SSLv3	SSLv3 protocol ciphers
TLSv1	SSLv3/TLSv1 protocol ciphers
TLSv1_ONLY	TLSv1 protocol ciphers

Cipher Group Name	Description
EXP	Export ciphers
EXPORT	Export ciphers
EXPORT40	Export ciphers with 40bit encryption
EXPORT56	Export ciphers with 56bit encryption
LOW	Low strength ciphers (56bit encryption)
MEDIUM	Medium strength ciphers (128bit encryption)
HIGH	High strength ciphers (168bit encryption)
AES	AES Ciphers
FIPS	FIPS Approved Ciphers
ECDHE	Elliptic Curve Ephemeral DH Ciphers
AES-GCM	Ciphers with Enc algo as AES-GCM
SHA2	Ciphers with MAC algo as SHA-2

Viewing the Predefined Cipher Groups

To view the predefined cipher groups, on the **Configuration** tab, in the navigation pane, expand **Management Service**, and then click **Cipher Groups**.

Creating Custom Cipher Groups

You can create custom cipher groups from the list of supported SSL ciphers.

To create custom cipher groups:

1. On the **Configuration** tab, in the navigation pane, expand **Management Service**, and then click **Cipher Groups**.
2. In the **Cipher Groups** pane, click **Add**.
3. In the **Create Cipher Group** dialog box, perform the following:
 - a) In the **Group Name** field, enter a name for the custom cipher group.
 - b) In the **Cipher Group Description** field, enter a brief description of the custom cipher group.
 - c) In the **Cipher Suites** section, click **Add** and select the ciphers to include in the list of supported SSL ciphers.
 - d) Click **Create**.

Viewing Existing SSL Cipher Bindings

To view the existing cipher bindings, on the **Configuration** tab, in the navigation pane, expand **System**, and then click **Configure SSL Settings** under **System Settings**.

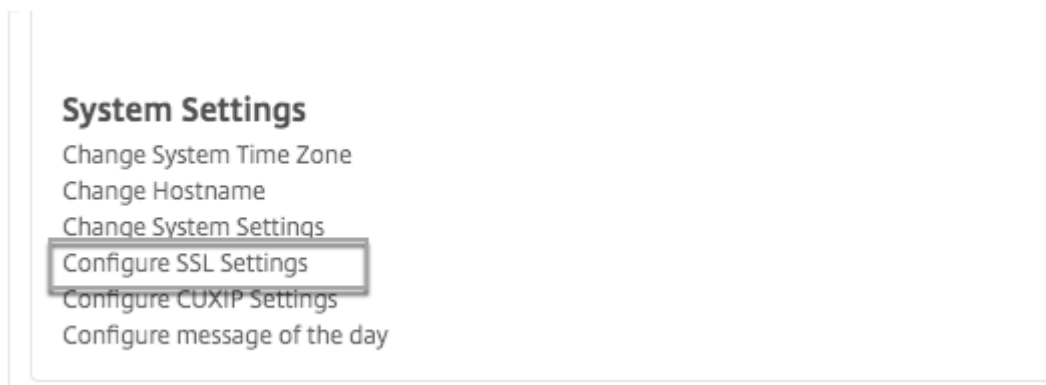

Note

After you upgrade to the latest version of the Management Service, the list of existing cipher suites shows the OpenSSL names. Once you bind the ciphers from the upgraded Management Service, the display uses the Citrix® naming convention.

Binding Ciphers to the HTTPS Service

To bind ciphers to the HTTPS service:

1. On the **Configuration** tab, in the navigation pane, click **System**.
2. In the **System** pane, under System Settings, click **Configure SSL Settings**.
3. In the **Edit Settings** pane, click **Ciphers Suites**.
4. In the **Ciphers Suites** pane, do either of the following:
 - To choose cipher groups from predefined cipher groups provided by SDX appliance, select the **Cipher Groups** check box, select the cipher group from the **Cipher Groups** drop-down list, and then click **OK**.
 - To choose from the list of supported ciphers, select the **Cipher Suites** check box, click **Add** to select the ciphers, and then click **OK**.

Back up and restore the configuration data of the SDX appliance

September 27, 2025

The NetScaler SDX appliance backup process is a single step process that creates a backup file containing the following:

- Single bundle image:
 - Citrix Hypervisor™ image
 - Hotfixes and Supplemental Packs of Citrix Hypervisor
 - Management Service image
- XVA image
- Upgrade image
- SDX configuration
- Configuration

Note: Backup and restore are not supported on NetScaler SDX FIPS appliances.

To back up the current configuration:

1. On the **Configuration** tab, in the navigation pane, expand **Management Service**, and then click **Backup Files**.
2. In the **Backup Files** pane, click **Back Up**.
3. In the **New Backup File** dialog box, select the **Password Protect file** check box to encrypt the backup file.
4. In the **Password** and **Confirm Password** fields, type and confirm the password for the backup file.
5. Click **Continue**.

The backup process creates a backup file. The file name of the backup file includes the current IP address of the Management Service and the timestamp when the backup was taken. To check for any discrepancy that the backup file might have, from the SDX GUI navigate to **Configuration > System > Events/Alarms**.

Scheduled Backup

By default, SDX creates a backup every 24 hours using a backup policy. Using the backup policy, you can define the number of backup files that you want to retain in the SDX appliance. Also, you can encrypt the scheduled backup files using a password to ensure that the backup file is secure.

To edit the backup policy:

1. On the **Configuration** tab, click **System**.
2. In the **Policy Administration** pane, click **Backup Policy**.
3. In the **Configure backup policy** pane, perform the following:

- a) In the **Previous backups to retain** field, type the number of backup files you want to retain.
- b) To encrypt the backup files, select **Encrypt Backup File** check box.
- c) In the **Password** and **Confirm Password** fields, type and confirm the password to encrypt the backup file.

Manually Transfer the Backup File to an External Backup Server

You can manually transfer the backup file to an external backup server. Ensure that you have the external backup server details before you manually transfer the backup file.

To manually transfer the backup file to an external backup server:

1. On the **Configuration** tab, in the navigation pane, expand **Management Service**, and then click **Backup Files**.
2. In the **Backup Files** pane, select the backup file and then click **Transfer**.
3. In the **Server** field, type the host name or IP address of the external backup server.
4. In the **User Name** and **Password** fields, type the user name and password to access the external backup server.
5. In the **Port** field, type the port number.
6. In the **Transfer Protocol** field, select the protocol you want to use to transfer the backup file to the external backup server.
7. In the **Directory Path** field, type the path of the directory in the external backup server where you want to store the backup files.
8. Select **Delete file from Management Service** after transfer if you want to delete the backup file from the SDX appliance after you have transferred the backup file to the external backup server.
9. Click **OK**.

Restore the appliance

You can restore the SDX appliance to the configuration available in the backup file. During the appliance restore, all the current configuration is deleted.

Points to note:

- Before you restore the SDX appliance using the backup file of a different SDX appliance, add the Management Service network settings according to the settings available in the backup file.
- Ensure that the platform variant on which the backup was taken is the same as on which you are trying to restore. Restoring the backup file between two different platform variants is not supported.
- Citrix® recommends restoring SDX backup only after the network configuration is set. You can specify the following network settings for the SVM:

- SVM IP address
- Hypervisor IP address
- Subnet mask
- Gateway
- DNS server

To restore the appliance from the backup file:

1. On the **Configuration** tab, in the navigation pane, expand **Management Service**, and then click **Backup Files**.
2. In the **Backup Files** pane, click the backup file and then click **OK**.
3. In the **Restore** dialog box, select **Appliance Restore**, and then click **Proceed**.

A page appears, showing the different components of the application restore:

- License
- SDX Image
- XVA Files
- Citrix ADC configuration
- Summary

If any of the required components such as a valid and capable license, XVA images, Citrix ADC images, Single Bundle image are missing in the backup file, you're prompted to upload the missing element before proceeding further.

To know whether a backup file can be restored on the current SDX Single Bundle Image Version, see this table.

Current SDX Single Bundle Image Version	Backup File Version
11.0	supported on 11.0, 12.0
11.1	supported on 11.1, 12.0; not supported on 11.0
12.0	supported on 12.0; not supported on 11.0 and 11.1

4. On the **License** page, check that a valid license is present and click **Next**.
5. The **SDX Image** page appears. If an SDX image is not required to perform the restore, click **Next**. Otherwise, when prompted upload a valid SDX image and click **Next**.
6. The **XVA File** page opens. Click **Next** if XVA images for all instances are present. If the XVA file for any instance is missing in the backup file, you can either upload it or skip restoring this instance. Click **Next** to go to the next page.

7. The Citrix ADC Configuration page opens. Citrix ADC configuration files are not mandatory. You can provision the instance without restoring its configuration. If the Citrix ADC configuration file is missing in the backup file, you can either proceed only with instance provisioning or skip restoring the instance. Click **Next** to go to the next page.

8. The summary page appears with the following details about all the instances present in the backup file:

- IP address
- Host name
- SDX version
- XVA version
- Version bit
- Restore: if the appliance or instance is ready for restore, a check mark appears. If it's not, a cross mark appears.
- Error messages: if the appliance or instance is not ready for restore, an error message appears, explaining the reason.

9. Click **Restore** to complete the application restore process.

Restore the Citrix ADC instance

You can restore the Citrix ADC instance in the SDX appliance to the Citrix ADC instances that are available in the backup file.

Points to note:

- A VPX instance fails to restore if the instance does not have any management NIC assigned to it and if the instance is managed from the SDX Management Service only through LACP. The restore fails because SDX Management Service cannot restore the channel configurations automatically. To avoid this issue, manually restore the channel configuration to complete the VPX instance restore.

Restore the Citrix ADC instance in the backup file

1. On the **Configuration** tab, in the navigation pane, expand **Management Service**, and then click **Backup Files**.
2. In the **Backup Files** pane, select the backup file and then click **Restore**.
3. In the **Restore** dialog box, select **Instance Restore**.
4. Select the Citrix ADC instances that you want to restore and then click **Proceed**.
5. (Optional) If the backup file is encrypted, when prompted, type the password and then click **OK**.

Note:

Ensure that the appropriate XVA, build image, and channel configuration are present on the SDX appliance that runs the instance that is being restored.

Performing Appliance Reset

September 27, 2025

The NetScaler SDX appliance allows you to:

- Reset the configuration of the Appliance.
- Reset the Appliance to factory version
- Reset the Appliance to a particular Single Bundle Image version

Before performing an appliance reset, back up all the data stored on the appliance, including the settings of all the Citrix® ADC instances provisioned on the appliance.

Citrix recommends that you store the files outside the appliance. Performing an appliance reset terminates all current client sessions with the Management Service, so you have to log back on to the Management Service for any additional configuration tasks. When you are ready to restore the data, import the backup files by using the Management Service.

The Management Service provides the following options to reset the Appliance:

- Config Reset
- Factory Reset
- Clean Install

Resetting the Configuration of the Appliance

The Management Service provides the Config Reset option to reset the configuration of the Appliance.

The Config Reset option performs the following:

- Deletes VPX instances.
- Deletes SSL certificate and key files.
- Deletes license and technical archive files.
- Deletes the NTP configuration on the appliance.
- Restores the time zone to UTC.
- Restores prune and backup policies to their default settings.
- Deletes the Management Service image.

- Deletes the NetScaler SDX image.
- Deletes all XVA images except the last image file that was accessed on the appliance.
- Restores default interface settings.
- Restores the default configuration of the appliance, including default profiles, users, and system settings.
- Restores default passwords for Citrix Hypervisor™ and the Management Service.
- Restarts the Management Service.

To reset the configuration of the Appliance:

1. Under the **Configuration** tab, click the **System** node and then under the **System Administration** group, click **Appliance Reset**.
2. In the **Appliance Reset** dialog box, select **Config Reset** in the **Reset Type** drop-down list, and click **OK**.

Resetting the Appliance to Factory Version

The Management Service provides the Factory Reset option to reset the appliance to the factory version. The Factory Reset option resets the current IP addresses of the Management Service and Citrix Hypervisor to the default IP addresses of the Management Service and Citrix Hypervisor.

Before performing a factory reset, back up all the data stored on the appliance, including the settings of all the Citrix ADC instances provisioned on the appliance. Citrix recommends that you store the files outside the appliance. Performing a factory reset terminates all current client sessions with the Management Service. Log back on to the Management Service for any additional configuration tasks. When you are ready to restore the data, import the backup files by using the Management Service.

Important

Make sure you connect a serial console cable to the appliance before performing a factory reset.

To reset the Appliance to factory version:

1. Under **Configuration** tab, click **System** node and then under the **System Administration** group, click **Appliance Reset**.
2. In the **Appliance Reset** dialog box, select **Factory Reset** in the **Reset Type** drop-down list, and click **OK**.

Resetting the Appliance to a Single Bundle Image Version

The Management Service provides the Clean Install option that allows you to install an arbitrary version of the single bundle image on the appliance. It enables you to perform a fresh install of the single

bundle image as the new default boot image. Clean installation removes the existing configuration, except network settings, in the SDX appliance.

The clean install option is supported on the following:

Single Bundle Image Version	SDX Platforms
11.0.xx	SDX 14xxx, SDX 25xxx. Note: The clean-install option is supported on other SDX platforms if they have 10G factory partition.
11.1.xx	SDX 14xxx, SDX 25xxx. Note: The clean-install option is supported on other SDX platforms if they have 10G factory partition
11.1.51.x	All the SDX platforms.

Prerequisites

Make sure that:

- You fail over all the primary HA nodes to a different SDX appliance. If you do not have HA capabilities, make sure that you plan for the downtime accordingly.
- Download the single bundle image to your local machine.

Important

Make sure that you do not restart or power cycle the appliance while using the Clean Install option.

To reset the Appliance to a single bundle image version

1. Under **Configuration** tab, click **System** node and then under the **System Administration** group, click **Appliance Reset**.
2. In the **Appliance Reset** dialog box, select **Clean Install** in the **Reset Type** drop-down list, and click **OK**.

Cascading External Authentication Servers

September 27, 2025

Cascading multiple external authentication servers provides a continuous, reliable process for authenticating and authorizing external users. If authentication fails on the first authentication server,

the NetScaler SDX Management Service attempts to authenticate the user by using the second external authentication server, and so on.

To enable cascading authentication, you need to add the external authentication servers to the Management Service. For more information, see [Configuring External Authentication](#). You can add any type of the supported external authentication servers (RADIUS, LDAP, and TACACS). For example, if you want to add four external authentication servers for cascading authentication, you can add two RADIUS servers, one LDAP server, and one TACACS server, or four servers of the same type. You can configure up to 32 external authentication servers in Citrix Application Delivery Management.

Note:

Cascading external authentication servers through CLI are not supported.

To cascade external authentication servers:

1. On the **Configuration** tab, under **System**, expand **Authentication**.
2. In the **Authentication** page, click **Authentication Configuration**.
3. In the **Authentication Configuration** page, select **EXTERNAL** from the **Server Type** drop-down list (you can cascade only external servers).
4. Click **Insert**, and on the **External Servers** page that opens, select one or multiple authentication servers that you would like to cascade.
5. Click **OK**.

The selected servers are displayed on the **Authentication Servers** page as shown in the figure below. You can specify the order of authentication by using the icon next to a server name to move the server up or down in the list.

← Authentication Configuration

The appliance can authenticate users with local user accounts or by using an external authentication server.

Server Type*

EXTERNAL

External Servers

Insert Delete

<input checked="" type="checkbox"/>	Server Type	Server Name
<input checked="" type="checkbox"/>	RADIUS	10.102.166.80
<input checked="" type="checkbox"/>	LDAP	_LDAP2
<input checked="" type="checkbox"/>	LDAP	_LDAP1

Enable fallback local authentication

OK Close

Provisioning Citrix® ADC instances

September 27, 2025

Note

The Citrix ADM service connect is enabled by default, after you install or upgrade the NetScaler SDX appliance to release 12.1 build 58.xx and above. For more details, see [Data governance](#) and [Citrix ADM service connect](#).

You can provision one or more Citrix ADC instances on the SDX appliance by using the Management Service. The number of instances that you can install depends on the license you have purchased. If the number of instances added is equal to the number specified in the license, the Management Service does not allow provisioning more Citrix ADC instances.

Provisioning a NetScaler VPX instance on the SDX appliance comprises the following steps.

1. Define an admin profile to attach to the Citrix ADC instance. This profile specifies the user credentials that are used by the Management Service to provision the Citrix ADC instance and later, to communicate with the instance to retrieve configuration data. You can also use the default admin profile.

2. Upload the .xva image file to the Management Service.
3. Add a Citrix ADC instance using the Provision Citrix ADC wizard in the Management Service. The Management Service implicitly deploys the Citrix ADC instance on the SDX appliance and then downloads configuration details of the instance.

Warning

Make sure that you modify the provisioned network interfaces or VLANS of an instance using the Management Service instead of performing the modifications directly on the instance.

Create an admin profile

Admin profiles specify the user credentials that are used by the Management Service when provisioning the Citrix ADC instances, and later when communicating with the instances to retrieve configuration data. The user credentials specified in an admin profile are also used by the client when logging on to the Citrix ADC instances through the CLI or the configuration utility.

Admin profiles also enable you to specify that the Management Service and a VPX instance must communicate with each other only over a secure channel or using HTTP.

The default admin profile for an instance specifies a user name of `nsroot`. This profile cannot be modified or deleted. However, you must override the default profile by creating a user-defined admin profile and attaching it to the instance when you provision the instance. The Management Service administrator can delete a user-defined admin profile if it is not attached to any Citrix ADC instance.

Important:

Do not change the password directly on the VPX instance. If you do so, the instance becomes unreachable from the Management Service. To change a password, first create an admin profile, and then modify the Citrix ADC instance, selecting this profile from the Admin Profile list.

To change the password of Citrix ADC instances in a high availability setup, first change the password on the instance designated as the secondary node, and then change the password on the instance designated as the primary node. Remember to change the passwords only by using the Management Service.

To create an admin profile

1. On the **Configuration** tab, in the navigation pane, expand **Citrix ADC Configuration**, and then click **Admin Profiles**.
2. In the **Admin Profiles** pane, click **Add**.

3. The **Create Admin Profile** dialog box appears.

← Create Citrix ADC Profile

Profile Name*

 X Please enter value

User Name

Password*

Use global settings for Citrix ADC communication

▼ SNMP

Version

v2 v3

Security Name*

Security Level*

▼ Timeout Settings

commandcenter.timeout_settings

Timeout (in Seconds)

Set the following parameters:

- Profile Name: name of the admin profile. The default profile name is `nsroot`. You can create user-defined profile names.
- Password: the password used to log on to the Citrix ADC instance. Maximum length: 31 characters.

- SSH Port: set the SSH port. The default port is 22.
 - Select **Use global settings for Citrix ADC communication** check box, if you want the setting to be defined in the System Settings for the communication between the Management Service and the Citrix ADC instance. You can clear this box and change the protocol to HTTP or HTTPS.
 - Select **http** option to use HTTP protocol for the communication between the Management Service and the Citrix ADC instance.
 - Select **https** option to use secure channel for the communication between the Management Service and the Citrix ADC instance
4. Under **SNMP**, select the version. If you select v2, go to step 5. If you select v3, go to step 6.
 5. Under SNMP v2, add the SNMP **Community** name.
 6. Under SNMP v3, add **Security Name** and **Security Level**.
 7. Under **Timeout Settings**, specify the value.
 8. Click **Create**, and then click **Close**. The admin profile that you created appears in the **Admin Profiles** pane.

If the value in the **Default** column is true the default profile is the admin profile. If the value is false, a user-defined profile is the admin profile.

If you do not want to use a user-defined admin profile, you can remove it from the Management Service. To remove a user-defined admin profile, in the **Admin Profiles** pane, select the profile you want to remove, and then click **Delete**.

Upload a Citrix ADC .xva image

A .xva file is required for adding a NetScaler VPX instance.

Upload the Citrix ADC SDA .xva files to the SDX appliance before provisioning the VPX instances. You can also download a .xva image file to a local computer as a backup. The .xva image file format is: NSVPX-XEN-ReleaseNumber-BuildNumber_nc.xva

Note: By default, a .xva image file based on the Citrix ADC 9.3 release is available on the SDX appliance.

In the **Citrix ADC XVA Files** pane, you can view the following details.

- **Name**

Name of the .xva image file. The file name contains the release and the build number. For example, the file name NSVPX-XEN-9.3-25_nc.xva refers to release 9.3 build 25.

- **Last Modified**

Date when the .xva image file was last modified.

- **Size**

Size, in MB, of the .xva image file.

To upload a Citrix ADC .xva file

1. On the **Configuration** tab, in the navigation pane, expand **Citrix ADC Configuration**, and then click **XVA Files**.
2. In the **Citrix ADC XVA Files** pane, click **Upload**.
3. In the **Upload Citrix ADC instance XVA** dialog box, click **Browse** and select the XVA image file that you want to upload.
4. Click **Upload**. The XVA image file appears in the **Citrix ADC XVA Files** pane after it is uploaded.

To create a backup by downloading a Citrix ADC .xva file

1. In the **Citrix ADC Build Files** pane, select the file that you want to download, and then click **Download**.
2. In the **File Download** message box, click **Save**.
3. In the **Save As** message box, browse to the location where you want to save the file, and then click **Save**.

Add a Citrix ADC instance

When you add Citrix ADC instances from the Management Service, you need to provide values for some parameters, and the Management Service implicitly configures these settings on the Citrix ADC instances.

Name:

Assign a name to the Citrix ADC instance.

Next, select an IPv4 or IPv6 address or both IPv4 and IPv6 addresses to access the NetScaler VPX instance for the management purpose.

A Citrix ADC instance can have only one management IP (also called NSIP). You cannot remove an NSIP address.

Assign a netmask, default gateway, and next hop to Management Service for the IP address.

Next, add the XVA file, Admin Profile, and a description for the instance.

← Provision Citrix ADC

Name*
 ?

IPv4

IPv4 Address*

Netmask*

Gateway

Nexthop to Management Service

IPv6

XVA File*
 ▾

Admin Profile*
 ▾

Description

Note: For a high availability setup (active-active or active-standby), Citrix recommends that you configure the two NetScaler VPX instances on different SDX appliances. Make sure that the instances in the setup have identical resources, such as CPU, memory, interfaces, packets per second (PPS), and throughput.

License allocation

In this section, specify the license you have procured for the Citrix ADC. The license can be Standard, Enterprise, and Platinum or Secure Web Gateway.

Note: * indicates required fields.

Note

Buy a separate license (SDX 2-Instance Add-On Pack for Secure Web Gateway) for Citrix Secure Web Gateway™ (SWG) instances on SDX appliances. This instance pack is different from the SDX platform license or SDX instance pack.

For more information about deploying a Citrix SWG instance on an SDX appliance, see [Deploying a Citrix Secure Web Gateway Instance on an SDX Appliance](#).

License Allocation			
Feature License* Standard		For more information about Citrix ADC editions, see Citrix ADC Editions	
Pool	Total	Available	Allocate
Instance	0	0	1
Bandwidth			Allocation Mode* Fixed
	0 Gbps	0 Gbps	Throughput (Mbps)* 1000

If you need bandwidth bursting ability, select **Burstable** under **Allocation Mode**. For more information, see [Bandwidth Metering in SDX](#).

Crypto allocation

Starting with release 12.1 48.13, the interface to manage crypto capacity has changed. For more information, see [Manage crypto capacity](#).

Resource allocation

Under resource allocation, assign total memory, packets per second, and CPU.

Resource Allocation

Total Memory (MB)*
2048

Max packets per second*
2147483647

CPU*
Dedicated (2 core) ⓘ

Add an extra management CPU

CPU:

Assign a dedicated core or cores to the instance, or the instance shares a core with other instances. If you select shared, then one core is assigned to the instance but the core might be shared with other instances if there is a shortage of resources. Reboot affected Instances if CPU cores are reassigned. Restart the instances on which CPU cores are reassigned to avoid any performance degradation.

From SDX release 11.1.x.x (MR4), if you are using the SDX 2500xx platform, you can assign a maximum of 16 cores to an instance. Also, if you are using the SDX 2500xxx platform, you can assign a maximum of 11 cores to an instance.

Note: For an instance, the maximum throughput that you configure is 180 Gbps.

The following table lists the supported VPX, Single bungle image version, and the number of cores you can assign to an instance:

Platform	Total cores	Total cores available for provisioning VPX instances	Maximum cores that can be assigned to a single instance
SDX 8015, SDX 8400, and SDX 8600	4	3	3
SDX 8900	8	7	7
SDX 11500, SDX 13500, SDX 14500, SDX 16500, SDX 18500, and SDX 20500	12	10	5
SDX 11515, SDX 11520, SDX 11530, SDX 11540, and SDX 11542	12	10	5
SDX 17500, SDX 19500, and SDX 21500	12	10	5
SDX 17550, SDX 19550, SDX 20550, and SDX 21550	12	10	5
SDX 14020, SDX 14030, SDX 14040, SDX 14060, SDX 14080 and SDX 14100	12	10	5
SDX 22040, SDX 22060, SDX 22080, SDX 22100, and SDX 22120	16	14	7
SDX 24100 and SDX 24150	16	14	7
SDX 14020 40G, SDX 14030 40G, SDX 14040 40G, SDX 14060 40G, SDX 14080 40G and SDX 14100 40G	12	10	10

Platform	Total cores	Total cores available for provisioning VPX instances	Maximum cores that can be assigned to a single instance
SDX 14020 FIPS, SDX 14030 FIPS, SDX 14040 FIPS, SDX 14060 FIPS, SDX 14080 FIPS and SDX 14100 FIPS	12	10	10
SDX 14040 40S, SDX 14060 40S, SDX 14080 40S, and SDX 14100 40S	12	10	10
SDX 25100A, 25160A, 25200A	20	18	9
SDX 25100-40G, 25160-40G, 25200-40G	20	18	16 (if version is 11.1-51.x or higher); 9 (if version is 11.1-50.x or lower; all versions of 11.0 and 10.5)
SDX 26100, 26160, 26200, 26250	28	26	16
SDX 26100-50S, 26160-50S, 26200-50S, 26250-50S	28	26	16
SDX 26100-100G, 26160-100G, 26200-100G, 26250-100G	28	26	26
15000-50G	16	14	14

Note

Dedicated cores map to the number of packet engines running on the instance. For a VPX instance created with dedicated cores, an extra CPU is assigned for management.

Instance administration

You can create an admin user for the VPX instance by selecting **Add Instance Administration** under **Instance Administration**.

Instance Administration

Add Instance Administration

User Name*

Password*

Confirm Password*

Shell/SFTP/SCP Access

Add the following details:

User name: The user name for the Citrix ADC instance administrator. This user has superuser access but does not have access to networking commands to configure VLANs and interfaces.

Password: The password for the user name.

Shell/Sftp/Scp Access: The access allowed to the Citrix ADC instance administrator. This option is selected by default.

Network settings

- Allow L2 Mode under network settings.

You can allow L2 mode on the Citrix ADC instance. Select **Allow L2 Mode** under **Networking Settings**. Before you log on to the instance and enable L2 mode. For more information, see [Allowing L2 Mode on a Citrix ADC instance](#).

Network Settings

Allow L2 Mode ?

0/1 VLAN Tag

0/2 VLAN Tag

Data Interfaces

	Interface	Allow Untagged Traffic	Allowed VLANs
<i>No items</i>			

Note: If you disable L2 mode for an instance from the Management Service, you must log on to the instance and disable L2 mode from that instance. Failure to do so might cause all the other Citrix ADC modes to be disabled after you restart the instance

By default interface 0/1 and 0/2 are selected for management LA.

VLAN tag: specify a VLAN ID for the management interface.

Next, add data interfaces.

Note: The interface IDs of interfaces that you add to an instance do not necessarily correspond to the physical interface numbering on the SDX appliance. For example, if the first interface that you associate with instance 1 is SDX interface 1/4, it appears as interface 1/1 when you log on to the instance and view the interface settings, because it is the first interface that you associated with instance 1.

Add Data Interface

Interfaces*

1/4
▼

Allow Untagged Traffic

Allowed VLANs

100-110,142,151-155

MAC Address Mode*

Default
▼

▼ VMAC Settings (IPv4 and IPv6 VRIDs to configure Virtual MAC)

VRID IPv4

100-110,142,151-155

VRID IPv6

100-110,142,151-155

Add

Close

- **Allowed VLANs:** Specify a list of VLAN IDs that can be associated with a Citrix ADC instance.
- **MAC Address Mode:** Assign a MAC address. Select from one of the following options:
 - Default: Citrix Hypervisor™ assigns a MAC address.

- Custom: Choose this mode to specify a MAC address that overrides the generated MAC address.
 - Generated: Generate a MAC address by using the base MAC address set earlier. For information about setting a base MAC address, see [Assigning a MAC Address to an Interface](#).
- **VMAC Settings (IPv4 and IPv6 VRIDs to configure Virtual MAC)**
 - VRID IPV4: The IPv4 VRID that identifies the VMAC. Possible values: 1–255. For more information, see [Configuring VMACs on an Interface](#).
 - VRID IPV6: The IPv6 VRID that identifies the VMAC. Possible values: 1–255. For more information, see [Configuring VMACs on an Interface](#).

Management VLAN settings

Typically, the Management Service and the management address (NSIP) of the VPX instance are in the same subnetwork, and communication is over a management interface. However, if the Management Service and the instance are in different subnetworks, you have to specify a VLAN ID at the time of provisioning a VPX instance, so that the instance can be reached over the network when it starts. If your deployment requires that the NSIP not be accessible through any interface other than the one selected at the time of provisioning the VPX instance, select the NSVLAN option.

Citrix recommends that you do not select **NSVLAN**. You cannot change this setting after you have provisioned the Citrix ADC instance.

Management VLAN Settings

VLAN for Management Traffic

 L2VLAN
When this option is selected, the configured VLAN is created as a data VLAN on NetScaler instance, and is used by the Management Service to access the NSIP for all communication with the instance. This option is suitable for performing in-band management of the instance over the data VLAN, without creating a separate management network.
 NSVLAN
When this option is selected, the configured VLAN is created as the NSVLAN on NetScaler instance, and is used by the Management Service to access the NSIP for all communication with the instance. This option is suitable for performing out-of-band management of the instance over a separate management network. i.e., the NSVLAN.
 Tagall
Interfaces

Configured (0) Remove All

No items

+ Add

Done Close

Note:

- HA heartbeats are sent only on the interfaces that are part of the NSVLAN.
- You can configure an NSVLAN only from VPX XVA build 9.3–53.4 and later.

Important: If NSVLAN is not selected, running the “clear config full” command on the VPX instance deletes the VLAN configuration.

Click **Done** to provision the NetScaler VPX appliance.

Modify a Citrix ADC instance

To modify the values of the parameters of a provisioned Citrix ADC instance, in the Citrix ADC instances pane, select the instance that you want to modify, and then click **Modify**. In the Modify ADC Wizard, modify the parameters.

Note: If you modify the following parameters:

number of SSL chips, interfaces, memory, and feature license, the Citrix ADC instance implicitly stops and restarts to bring these parameters into effect.

You cannot modify the Image and User Name parameters.

If you want to remove a Citrix ADC instance provisioned on the SDX appliance, in the **Citrix ADC instances** pane, select the instance that you want to remove, and then click **Delete**. In the **Confirm** message box, click **Yes** to remove the Citrix ADC instance.

Restrict VLANs to specific virtual interfaces

The SDX appliance administrator can enforce specific 802.1Q VLANs on the virtual interfaces associated with Citrix ADC instances. This capability is especially helpful in restricting the usage of 802.1Q VLANs by the instance administrators. If two instances belonging to two different companies are hosted on an SDX appliance, you can restrict the two companies from using the same VLAN ID, so that one company does not see the other company's traffic. If an instance administrator, while provisioning or modifying a VPX instance, tries to assign an interface to an 802.1Q VLAN, a validation is performed to verify that the VLAN ID specified is part of the allowed list.

By default, any VLAN ID can be used on an interface. To restrict the tagged VLANs on an interface, specify the VLAN IDs in the Network Settings at the time of provisioning a Citrix ADC instance, or later by modifying the instance. To specify a range, separate the IDs with a hyphen (for example 10–12). If you initially specify some VLAN IDs but later delete all of them from the allowed list, you can use any VLAN ID on that interface. In effect, you have restored the default setting.

After creating a list of allowed VLANs, the SDX administrator does not have to log on to an instance to create the VLANs. The administrator can add and delete VLANs for specific instances from the Management Service.

Important

If L2 mode is enabled, the administrator must take care that the VLAN IDs on different Citrix ADC instances do not overlap.

To specify the permitted VLAN IDs

1. In the Provision ADC Wizard or the Modify ADC Wizard, on the Network Settings page, in the **Allowed VLANs** text box, specify one or more VLAN IDs allowed on this interface. Use a hyphen to specify a range. For example, 2–4094.
2. Follow the instructions in the wizard.
3. Click **Finish**, and then click **Close**.

To configure VLANs for an instance from the Management Service

1. On the **Configuration** tab, navigate to **Citrix ADC > Instances**.
2. Select an instance, and then click **VLAN**.
3. In the details pane, click **Add**.
4. In the **Create Citrix ADC VLAN** dialog box, specify the following parameters:
 - **VLAN ID**—An integer that uniquely identifies the VLAN to which a particular frame belongs. The Citrix ADC supports a maximum of 4094 VLANs. ID 1 is reserved for the default VLAN.
 - **IPv6 Dynamic Routing**—Enable all IPv6 dynamic routing protocols on this VLAN. Note: For the **ENABLED** setting to work, you must log on to the instance and configure IPv6 dynamic routing protocols from the VTYSH command line.
5. Select the interfaces that must be part of the VLAN.
6. Click **Create**, and then click **Close**.

Manage crypto capacity

September 27, 2025

Starting with release 12.1 48.13, the interface to manage crypto capacity has changed. With the new interface, the Management Service provides asymmetric crypto units (ACUs), symmetric crypto units (SCUs), and crypto virtual interfaces to represent SSL capacity on the NetScaler SDX appliance. Earlier crypto capacity was assigned in units of SSL chips, SSL cores, and SSL virtual functions. See the Legacy SSL chips to ACU and SCU conversion table for more information about how legacy SSL chips translate into ACU and SCU units.

By using the Management Service GUI, you can allocate crypto capacity to the NetScaler VPX instance in units of ACU and SCU.

The following table provides brief descriptions about ACUs, SCUs, and crypto virtual instances.

Table. Unit crypto units

New crypto units	Description
Asymmetric crypto unit (ACU)	1 ACU = 1 operation per second (ops) of (RSA) 2 K (2048-bit key size) decryption. For further details, see ACU to PKE resource conversion table.
Symmetric crypto unit (SCU)	1 SCU = 1 Mbps of AES-128-CBC + SHA256-HMAC @ 1024B. This definition is applicable for all SDX platforms.
Crypto virtual interfaces	Also known as virtual functions, crypto virtual interfaces represent the basic unit of the SSL hardware. After these interfaces are exhausted, the SSL hardware cannot be further assigned to a VPX instance. Crypto virtual interfaces are read-only entities, and the NetScaler SDX appliance automatically allocates these entities.

View crypto capacity of the SDX appliance

You can view the crypto capacity of the SDX appliance in the dashboard of the SDX GUI. The dashboard displays the used and available ACUs, SCUs, and virtual interfaces on the SDX appliance. To view the crypto capacity, navigate to **Dashboard > Crypto Capacity**.

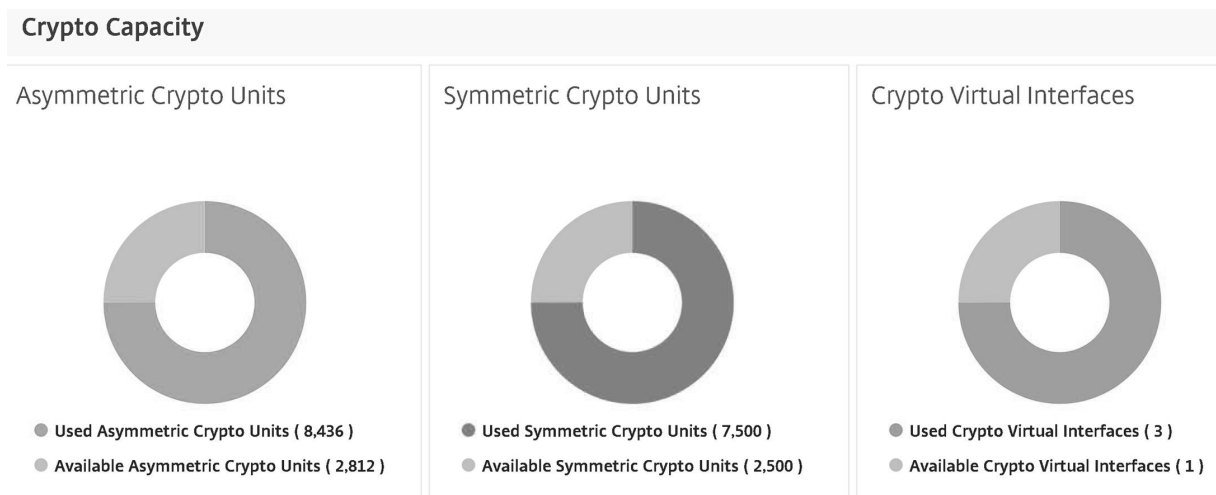

Allocate crypto capacity while provisioning the NetScaler VPX instance

While provisioning a VPX instance on an SDX appliance, under **Crypto Allocation**, you can allocate the number of ACUs and SCUs for the VPX instance. For instructions to provision a VPX instance, see [Provisioning Citrix ADC instances](#).

To allocate crypto capacity while provisioning a VPX instance, follow these steps.

1. Log on to the Management Service.
2. Navigate to **Configuration > Citrix® ADC > Instances**, and click **Add**.
3. Under **Crypto Allocation**, you can view the available ACUs, SCU, and crypto virtual interfaces. The way to allocate ACUs and SCUs differs depending on the SDX appliance:
 - a. For the appliances listed in the Minimum value of an ACU counter available for different SDX appliances table, you can assign ACUs in multiples of a specified number. SCUs are automatically allocated and the SCU allocation field is not editable. You can increase ACU allocation in the multiples of the minimum ACU available for that model. For example, if the minimum ACU is 4375, the subsequent ACU increment is 8750, 13125, and so on.

Example. Crypto allocation where SCUs are automatically assigned, and ACUs are assigned in multiples of a specified number.

Crypto Allocation			
	Asymmetric Crypto Units	Symmetric Crypto Units	Crypto Virtual Interfaces
Available	70000	56000	16
Total	70000	56000	16

Asymmetric Crypto Units
4375

Symmetric Crypto Units
3500

Minimum value of an ACU counter available for different SDX appliances table

SDX platform	ACU counter minimum value
22040, 22060, 22080, 22100, 22120, 24100, 24150 (36 ports)	2187
8400, 8600, 8010, 8015	2812
17500, 19500, 21500	2812
17550, 19550, 20550, 21550	2812
11500, 13500, 14500, 16500, 18500, 20500	2812
11515, 11520, 11530, 11540, 11542	4375
14xxx	4375
14xxx 40S	4375
14xxx 40G	4375

SDX platform	ACU counter minimum value
14xxx FIPS	4375
25xxx	4375
25xxx A	4575

b. For the rest of the SDX platforms, which are not listed in the preceding Minimum value of an ACU counter available for different SDX appliances table, you can freely assign ACUs and SCUs. The SDX appliance automatically allocates crypto virtual interfaces.

Example. Crypto allocation where both ACU and SCUs are freely assigned

Crypto Allocation			
	Asymmetric Crypto Units	Symmetric Crypto Units	Crypto Virtual Interfaces
Available	39000	41000	32
Total	39000	41000	32
Asymmetric Crypto Units			
	<input type="text" value="2000"/>		
Symmetric Crypto Units			
	<input type="text" value="2000"/>		

4./ Complete all the steps for provisioning the Citrix ADC instance, and click **Done**. For more information, see [Provisioning Citrix ADC instances](#).

View crypto hardware health

In Management Service, you can view the health of the crypto hardware provided with the SDX appliance. The health of the crypto hardware is represented as Crypto Devices and Crypto Virtual Functions. To view the health of the crypto hardware, navigate to **Dashboard > Resources**.

The screenshot shows the 'Resources' page in the Citrix ADC SDX GUI. It features a 'Hardware' tab and a table with the following data:

Name	Status	Current Value	Expected Value
CPUs	● Ok	1	1
Hyper-threads	● Ok	16	16
Memory	● Ok	32 GB	32 GB
Crypto Virtual Functions	● Ok	32	32
Crypto Devices	● Ok	1	1
Management Interfaces	● Ok	1	1
10G Interfaces	● Ok	4	4
1G Interfaces	● Ok	6	6
40G Interfaces	● Ok	0	0
Disks	● Ok	1	1

Points to note

Keep the following points in mind when you upgrade the SDX appliance to the latest version.

- Only the SDX user interface gets upgraded, but the hardware capacity of the appliance remains the same.
- The crypto allocation mechanism remains the same, and only the representation on the SDX GUI changes.
- Crypto interface is backward compatible, and it does not affect any existing automation mechanism that uses the NITRO interface to manage the SDX appliance.
- Upon SDX appliance upgrade, the crypto assigned to the existing VPX instances does not change; only its representation on the Management Service changes.

ACU to PKE resource conversion table

SDX platform	ACU	RSA-RSA1K	RSA-RSA2K	RSA-RSA4K	ECDHE-RSA	ECDHE-ECDSA
22040, 22060, 22080, 22100, 22120, 24100, 24150 (36 ports)	2187	12497	2187	312	256	190
8400, 8600, 8010, 8015	2812	17000	2812	424	330	N/A
11515, 11520, 11530, 11540, 11542	4375	25000	4375	625	512	381
22040, 22060, 22080,22100, 22120 (24 ports)	4375	25000	4375	625	512	381
17500, 19500, 21500	2812	17000	2812	424	330	N/A
17550, 19550, 20550, 21550	2812	17000	2812	424	330	N/A
11500, 13500, 14500, 16500, 18500, 20500	2812	17000	2812	424	330	N/A
14xxx, 14xxx 40G, 25xxx, 25xxx A	4375	25000	4375	625	512	381

SDX platform	ACU	RSA-RSA1K	RSA-RSA2K	RSA-RSA4K	ECDHE-RSA	ECDHE-ECDSA
14xxx FIPS	4375	25000	4375	625	512	381
14xxx 40S	4375	25000	4375	625	512	381
*89xx (8910, 8920, 8930)	1000	4615	1000	136	397	494
*26xxx (26100, 26160, 26200, and 26250)	1000	4615	1000	136	397	494
*15000 50G	1000	4615	1000	136	397	494
*26000-50S	1000	4615	1000	136	397	494

*On these platforms the PKE numbers are the minimum guaranteed values.

How to read the ACU to PKE resource conversion table

The ACU to PKE resource conversion table is based on the following points:

- Management Service helps allocate Crypto Resources to each individual VPX. Management Service cannot allocate or promise performance.
- Actual performance varies depending on packet size, cipher/Keyex/HMAC (or their variations) used, and so on

The following example helps you understand how to read and apply the “ACU to PKE” resource conversion table.

Example. ACU to PKE resource conversion for the SDX 22040 platform

Allocation of 2187 ACUs to a VPX instance on an SDX 22040 platform allocates crypto resource equivalent to 256 ECDHE-RSA operations or 2187 RSA-2K operations and so on.

Legacy SSL chips to ACU and SCU conversion table

For more information about how legacy SSL chips are converted to ACU and SCU, see the following table.

[ACU and SCU conversion table.](#)

Provisioning Third-Party Virtual Machines

September 27, 2025

The SDX appliance supports provisioning of the following third-party virtual machines (instances):

- SECUREMATRIX GSB
- InterScan Web Security
- Websense Protector
- BlueCat DNS/DHCP Server
- CA Access Gateway
- PaloAlto VM-Series

SECUREMATRIX GSB provides a highly secure password system that eliminates the need to carry any token devices. Websense Protector provides monitoring and blocking capabilities, preventing data loss and leaks of sensitive information. BlueCat DNS/DHCP Server delivers DNS and DHCP for your network. PaloAlto VM-Series on NetScaler SDX enables consolidation of advanced security and ADC capabilities on a single platform, for secure, reliable access to applications by businesses, business units, and service-provider customers. The combination of VM-Series on NetScaler SDX also provides a complete, validated, security and ADC solution for Citrix Virtual Apps and Desktops deployments.

You can provision, monitor, manage, and troubleshoot an instance from the Management Service. All the above third-party instances use the SDXTools daemon to communicate with the Management Service. The daemon is pre-installed on the provisioned instance. You can upgrade the daemon when new versions become available.

When you configure third-party virtual machines, then SR-IOV interfaces (1/x and 10/x) that are part of a channel do not appear in the list of interfaces because channels are not supported on third-party virtual machines.

Note:

The total number of instances that you can provision on an SDX appliance depends on the license installed on the appliance.

Important:

You must upgrade your Citrix Hypervisor version to version 6.1.0 before you install any third-party instance.

SECUREMATRIX GSB

September 27, 2025

SECUREMATRIX is a highly secure, tokenless, one-time-password (OTP) authentication solution that is easy to use and cost effective. It uses a combination of location, sequence, and image pattern from a matrix table to generate a single-use password. SECUREMATRIX GSB server with SECUREMATRIX Authentication server substantially enhances the security of VPN/SSL-VPN endpoints, cloud based applications and resources, desktop/virtual desktop login, and web applications (Reverse proxy with OTP), providing a solution that is compatible with PCs, Virtual Desktops, tablets, and smart phones.

By using the NetScaler SDX multitenant platform architecture in a software defined network (SDN), SECUREMATRIX's strong authentication feature can be easily combined or integrated with other tenants or cloud services delivered through the Citrix ADC, such as Web Interface, XenApp, XenDesktop, and many other application services that require authentication.

Note:

SR-IOV interfaces (1/x and 10/x) that are part of a channel do not appear in the list of interfaces because channels are not supported on a SECUREMATRIX GSB instance.

For more information, see [SECUREMATRIX](#).

Provisioning a SECUREMATRIX GSB Instance

SECUREMATRIX GSB requires a SECUREMATRIX Authentication server that must be configured outside the SDX appliance. Select exactly one interface and specify the network settings for only that interface.

Note:

SR-IOV interfaces (1/x and 10/x) that are part of a channel do not appear in the list of interfaces because channels are not supported on a SECUREMATRIX GSB instance.

You must download an XVA image from the SECUREMATRIX website and upload it to the SDX appliance before you start provisioning the instance. For more information about downloading an XVA image, see the SECUREMATRIX website. Make sure that you are using Management Service build 118.7 or later on the SDX appliance.

On the Configuration tab, navigate to SECUREMATRIX GSB > Software Images.

To upload an XVA image to the SDX appliance:

1. In the details pane, under XVA Files > Action, click Upload.
2. In the dialog box that appears, click Browse, and then select the XVA file that you want to upload.
3. Click Upload. The XVA file appears in the XVA Files pane.

To provision a SECUREMATRIX instance

1. On the Configuration tab, navigate to SECUREMATRIX GSB > Instances.

2. In the details pane, click Add.
3. In the Provision SECUREMATRIX GSB wizard, follow the instructions on the screen.
4. Click Finish, and then click Close.

After you provision the instance, log on to the instance and perform detailed configuration. For more information, see the [SECUREMATRIX](#) website.

To modify the values of the parameters of a provisioned SECUREMATRIX instance, in the SECUREMATRIX Instances pane, select the instance that you want to modify, and then click Modify. In the Modify SECUREMATRIX GSB wizard, modify the parameters.

Note: If you modify any of the interface parameters or the name of the instance, the instance stops and restarts to put the changes into effect.

You can generate a tar archive for submission to technical support. For information about generating a technical support file, see [Generating a Tar Archive for Technical Support](#).

You can also back up the configuration of a SECUREMATRIX GSB instance and later use the backup data to restore the configuration of the instance on the SDX appliance. For information about backing up and restoring an instance, see [Backing Up and Restoring the Configuration Data of the SDX Appliance](#).

Monitoring a SECUREMATRIX GSB Instance

The SDX appliance collects statistics, such as the version of SDXTools, the states of SSH and CRON daemons, and the Webserver state, of a SECUREMATRIX GSB instance.

To view the statistics related to a SECUREMATRIX GSB instance:

1. Navigate to **SECUREMATRIX GSB > Instances**.
2. In the details pane, click the arrow next to the name of the instance.

Managing a SECUREMATRIX GSB Instance

You can start, stop, restart, force stop, or force restart a SECUREMATRIX GSB instance from the Management Service.

On the Configuration tab, expand SECUREMATRIX GSB.

To start, stop, restart, force stop, or force restart an in:

1. Click Instances.
2. In the details pane, select the instance on which you want to perform the operation, and then select one of the following options:
 - Start

- Shut Down
- Reboot
- Force Shutdown
- Force Reboot

3. In the Confirm message box, click Yes.

Upgrading the SDXTools File for a SECUREMATRIX GSB Instance

SDXTools, a daemon running on the SECUREMATRIX GSB instance, is used for communication between the Management Service and the instance.

Upgrading SDXTools involves uploading the file to the SDX appliance, and then upgrading SDXTools after selecting an instance. You can upload an SDXTools file from a client computer to the SDX appliance.

To upload an SDXTools file:

1. In the navigation pane, expand Management Service, and then click SDXTools Files.
2. In the details pane, from the Action list, select Upload.
3. In the Upload SDXTools Files dialog box, click Browse, navigate to the folder that contains the file, and then double-click the file.
4. Click Upload.

To upgrade SDXTools:

On the Configuration tab, expand SECUREMATRIX GSB.

1. Click Instances.
2. In the details pane, select an instance.
3. From the Action list, select Upgrade SDXTools.
4. In the Upgrade SDXTools dialog box, select a file, click OK, and then click Close.

Upgrading and Downgrading SECUREMATRIX GSB Instance to a Later Version

The process of upgrading the SECUREMATRIX GSB instance involves uploading the software image of the target build to the SDX appliance, and then upgrading the instance. Downgrading loads an earlier version of the instance.

On the Configuration tab, expand SECUREMATRIX GSB.

To upload the software image:

1. Click Software Images.
2. In the details pane, from the Action list, select Upload.

3. In the dialog box, click Browse, navigate to the folder that contains the build file, and then double-click the build file.
4. Click Upload.

To upgrade the instance:

1. Click Instances.
2. In the details pane, select an instance.
3. From the Action list, select Upgrade.
4. In the dialog box that appears, select a file, click OK, and then click Close.

To downgrade an instance:

1. Click Instances.
2. In the details pane, select an instance.
3. From the Action list, select Downgrade.
4. In the Confirm message box, click Yes.

Troubleshooting a SECUREMATRIX GSB Instance

You can ping a SECUREMATRIX GSB instance from the Management Service to check whether the device is reachable. You can trace the route of a packet from the Management Service to an instance to determine the number of hops involved in reaching the instance.

You can rediscover an instance to view the latest state and configuration of an instance. During rediscovery, the Management Service fetches the configuration and the version of the SECUREMATRIX GSB running on the SDX appliance. By default, the Management Service schedules instances for rediscovery once every 30 minutes.

On the Configuration tab, expand SECUREMATRIX GSB.

To ping an instance:

1. Click Instances.
2. In the details pane, select the instance that you want to ping, and from the Action list, click Ping. The Ping message box shows whether the ping is successful.

To trace the route of an instance:

1. Click Instances.
2. In the details pane, select the instance for which you want to trace the route, and from the Action list, click TraceRoute. The Traceroute message box displays the route to the instance.

To rediscover an instance:

1. Click Instances.

2. In the details pane, select the instance that you want to rediscover, and from the Action list, click Rediscover.
3. In the Confirm message box, click Yes.

Trend Micro InterScan Web Security

September 27, 2025

Trend Micro InterScan Web Security is a software virtual appliance which dynamically protects against traditional and emerging web threats at the Internet gateway. By integrating application control, anti-malware scanning, real-time web reputation, flexible URL filtering, and advanced threat protection it delivers superior protection and greater visibility and control over the growing use of cloud-based applications on the network. Real-time reporting and centralized management give your administrators a proactive decision making tool, enabling on the spot risk management.

InterScan Web Security:

- Allows deeper visibility into end-user Internet activity
- Centralizes management for maximum control
- Monitors web use as it happens
- Enables on-the-spot remediation
- Reduces appliance sprawl and energy costs
- Provides optional data loss protection and sandbox executional analysis

Before you can provision an InterScan Web Security instance, you must download an XVA image from the Trend Micro website. After you have downloaded the XVA image, upload it to the NetScaler SDX appliance.

Note:

SR-IOV interfaces (1/x and 10/x) that are part of a channel do not appear in the list of interfaces because channels are not supported on a InterScan Web Security instance.

To upload an XVA image to the SDX appliance:

1. From the **Configuration** tab, navigate to **TrendMicro IWSVA > Software Images**.
2. In the details pane, under XVA Files tab , click **Upload**.
3. In the dialog box that appears, click **Browse**, and then select the XVA file that you want to upload.
4. Click **Upload**. The XVA file appears in the XVA Files pane.

To provision a TrendMicro IWSVA instance:

1. On the **Configuration** tab, navigate to **TrendMicro IWSVA > Instances**.

2. In the details pane, click **Add**.
3. In the **Provision TrendMicro IWSVA** wizard, follow the instructions on the screen.
4. Click **OK**, and then click **Close**.

After you have provisioned the instance, log on to the instance and perform the detailed configuration.

To modify the values of the parameters of a provisioned instance, in the details pane, select the instance that you want to modify, and then click **Edit**. In the Modify TrendMicro IWSVA wizard, set the parameters to values suitable for your environment.

Websense Protector

September 27, 2025

The Websense (now known as Forcepoint) Data Security protector is a virtual machine that intercepts outbound HTTP traffic (posts) and analyzes it to prevent data loss and leaks of sensitive information over the web. The protector communicates with a dedicated Windows server for DLP policy information and can monitor or block data from being posted when a match is detected. Content analysis is performed on box, so no sensitive data leaves the protector during this process.

To use the protector's data loss prevention (DLP) capabilities, you must purchase and install Websense Data Security, configure Web DLP policies in the Data Security manager, and perform initial setup through the Management Service.

For more information, see the [Websense Protector](#) website .

Provisioning a Websense Protector Instance

The Websense Protector requires a Data Security Management Server that must be configured outside the SDX appliance. Select exactly one management interface and two data interfaces. For the data interfaces, you must select Allow L2 Mode. Make sure that the Data Security Management Server can be accessed through the management network of the Websense protector. For the Name Server, type the IP address of the domain name server (DNS) that will serve this protector.

Note: SR-IOV interfaces (1/x and 10/x) that are part of a channel do not appear in the list of interfaces because channels are not supported on a Websense protector instance.

You must download a protector image from the Websense website and upload it to the SDX appliance before you start provisioning the instance. For more information about downloading a protector image, see the [Websense website](#) . Make sure that you are using Management Service build 118.7 or later on the SDX appliance.

On the Configuration tab, navigate to Websense Protector > Software Images.

To upload an XVA image to the SDX appliance

1. In the details pane, under XVA Files > Action, click Upload.
2. In the dialog box that appears, click Browse, and then select the XVA file that you want to upload.
3. Click Upload. The XVA file appears in the XVA Files pane.

To provision a Websense protector instance

1. On the Configuration tab, navigate to Websense Protector > Instances.
2. In the details pane, click Add.
3. In the Provision Websense Protector wizard, follow the instructions on the screen.
4. Click Finish, and then click Close.

After you provision the instance, log on to the instance and perform detailed configuration.

To modify the values of the parameters of a provisioned Websense protector instance, in the Websense Protector Instances pane, select the instance that you want to modify, and then click Modify. In the Modify Websense Protector wizard, set the parameters. Do not modify the interfaces that were selected at the time of provisioning a Websense instance. XVA file cannot be changed unless you delete the instance and provision a new one.

You can generate a tar archive for submission to technical support. For information about generating a technical support file, see [Generating a Tar Archive for Technical Support](#).

Monitoring a Websense Protector Instance

The SDX appliance collects statistics, such as the version of SDXTools, the status of the Websense Data Security policy engine, and the Data Security proxy status, of a Websense protector instance.

To view the statistics related to a Websense protector instance:

1. Navigate to Websense Protector > Instances.
2. In the details pane, click the arrow next to the name of the instance.

Managing a Websense Protector Instance

You can start, stop, restart, force stop, or force restart a Websense protector instance from the Management Service.

On the Configuration tab, expand Websense Protector.

To start, stop, restart, force stop, or force restart a Websense protector instance

1. Click Instances.
2. In the details pane, select the instance on which you want to perform the operation, and then select one of the following options:
 - Start
 - Shut Down
 - Reboot
 - Force Shutdown
 - Force Reboot
3. In the Confirm message box, click Yes.

Upgrading the SDXTools File for a Websense Protector Instance

SDXTools, a daemon running on the third-party instance, is used for communication between the Management Service and the third-party instance.

Upgrading SDXTools involves uploading the file to the SDX appliance, and then upgrading SDXTools after selecting an instance. You can upload an SDXTools file from a client computer to the SDX appliance.

To upload an SDXTools file

1. In the navigation pane, expand Management Service, and then click SDXTools Files.
2. In the details pane, from the Action list, select Upload.
3. In the Upload SDXTools Files dialog box, click Browse, navigate to the folder that contains the file, and then double-click the file.
4. Click Upload.

To upgrade SDXTools

On the Configuration tab, expand Websense Protector.

1. Click Instances.
2. In the details pane, select an instance.
3. From the Action list, select Upgrade SDXTools.
4. In the Upgrade SDXTools dialog box, select a file, click OK, and then click Close.

Upgrading the Websense Protector Instance to a Later Version

The process of upgrading the Websense protector instance involves uploading the software image of the target build to the SDX appliance, and then upgrading the instance.

On the **Configuration** tab, expand **Websense Protector**.

To upload the software image

1. Click Software Images.
2. In the details pane, from the Action list, select Upload.
3. In the dialog box, click Browse, navigate to the folder that contains the build file, and then double-click the build file.
4. Click Upload.

To upgrade the instance

1. Click Instances.
2. In the details pane, select an instance.
3. From the Action list, select Upgrade.
4. In the dialog box that appears, select a file, click OK, and then click Close.

Troubleshooting a Websense Protector Instance

You can ping a Websense protector instance from the Management Service to check whether the device is reachable. You can trace the route of a packet from the Management Service to an instance to determine the number of hops involved in reaching the instance.

You can rediscover an instance to view the latest state and configuration of an instance. During rediscovery, the Management Service fetches the configuration and the version of the Websense protector running on the SDX appliance. By default, the Management Service schedules instances for rediscovery once every 30 minutes.

On the Configuration tab, expand Websense Protector.

To ping an instance

1. Click Instances.
2. In the details pane, select the instance that you want to ping, and from the Action list, click Ping. The Ping message box shows whether the ping is successful.

To trace the route of an instance

1. Click Instances.
2. In the details pane, select the instance for which you want to trace the route, and from the Action list, click TraceRoute. The Traceroute message box displays the route to the instance.

To rediscover an instance

1. Click Instances.
2. In the details pane, select the instance that you want to rediscover, and from the Action list, click Rediscover.
3. In the Confirm message box, click Yes.

BlueCat DNS/DHCP

September 27, 2025

BlueCat DNS/DHCP Server is a software solution that can be hosted on the NetScaler SDX platform to deliver reliable, scalable and secure DNS and DHCP core network services without requiring additional management costs or data center space. Critical DNS services can be load balanced across multiple DNS nodes within a single system or across multiple SDX appliances without the need for additional hardware.

Virtual instances of BlueCat DNS/DHCP Server can be hosted on SDX to provide a smarter way to connect mobile devices, applications, virtual environments and clouds.

To learn more about BlueCat and Citrix, visit the BlueCat website at <https://citrixready.citrix.com/bluecat-networks.html>.

If you are an existing BlueCat customer, you can download software and documentation via the BlueCat support portal at <https://care.bluecatnetworks.com/>.

Provisioning a BlueCat DNS/DHCP Instance

You must download an XVA image from the Bluecat Customer Care, at <https://care.bluecatnetworks.com>. After you have downloaded the XVA image, upload it to the SDX appliance before you start provisioning the instance. Make sure that you are using Management Service build 118.7 or later on the SDX appliance.

Management channel across 0/1 and 0/2 interfaces are supported on BlueCat DNS/DHCP VMs. For more information see [Configuring channel from Management Service](#).

Note: SR-IOV interfaces (1/x and 10/x) that are part of a channel do not appear in the list of interfaces because channels are not supported on a BlueCat DNS/DHCP instance.

On the Configuration tab, navigate to BlueCat DNS/DHCP > Software Images.

To upload an XVA image to the SDX appliance:

1. In the details pane, under XVA Files > Action, click Upload.
2. In the dialog box that appears, click Browse, and then select the XVA file that you want to upload.
3. Click Upload. The XVA file appears in the XVA Files pane.

To provision a BlueCat DNS/DHCP instance:

1. On the Configuration tab, navigate to BlueCat DNS/DHCP > Instances.
2. In the details pane, click Add. The Provision BlueCat DNS/DHCP Server page opens.
3. In the Provision BlueCat DNS/DHCP wizard, follow the instructions on the screen.
 - Under Instance Creation, in the Name field, enter a name for the instance and select the uploaded image from the XVA File drop-down menu, then Click Next. Optionally, in the Domain Name field, enter a domain name for the instance.
Note: The name should contain no spaces.
 - Under Network Settings, from the Management Interface drop-down menu, select the interface through which to manage the instance, set the IP address and gateway for that interface. You can assign interfaces explicitly for high availability and service. Select the parameters and then click **Next**.
Note: When assigning interfaces for management, high availability and service, make sure you assign the interfaces based on supported combination of interfaces:

You can select the same interface for all three.

You can select a different interface for all three.

You can select the same interface for management and service, but select a different interface for high availability.

Click Finish, and then click Close. The instance will be created, booted, and configured with the selected IP address.

After you provision the instance, log on to the instance through SSH to complete the configuration. For details on how to configure the BlueCat DNS/DHCP Server or place it under the control of BlueCat Address Manager, see the appropriate BlueCat Administration Guide, available at <https://care.bluecatnetworks.com>.

To modify the values of the parameters of a provisioned BlueCat DNS/DHCP Server instance, from the BlueCat DNS/DHCP Instances pane, select the instance that you want to modify, and then click Modify. In the Modify BlueCat DNS/DHCP wizard, modify the parameter settings.

Note: If you modify any of the interface parameters or the name of the instance, the instance stops and restarts to put the changes into effect.

Monitoring a BlueCat DNS/DHCP Instance

The SDX appliance collects statistics, such as the version of SDXTools running on the instance, of a BlueCat DNS/DHCP instance.

To view the statistics related to a BlueCat DNS/DHCP instance:

1. Navigate to BlueCat DNS/DHCP > Instances.
2. In the details pane, click the arrow next to the name of the instance.

Managing a BlueCat DNS/DHCP Instance

You can start, stop, restart, force stop, or force restart a BlueCat DNS/DHCP instance from the Management Service.

On the Configuration tab, expand BlueCat DNS/DHCP.

To start, stop, restart, force stop, or force restart a BlueCat DNS/DHCP instance:

1. Click Instances.
2. In the details pane, select the instance on which you want to perform the operation, and then select one of the following options:
 - Start
 - Shut Down
 - Reboot
 - Force Shutdown
 - Force Reboot
3. In the Confirm message box, click Yes.

Upgrading the SDXTools File for a BlueCat DNS/DHCP Instance

SDXTools, a daemon running on the third-party instance, is used for communication between the Management Service and the third-party instance.

Upgrading SDXTools involves uploading the file to the SDX appliance, and then upgrading SDXTools after selecting an instance. You can upload an SDXTools file from a client computer to the SDX appliance.

To upload an SDXTools file:

1. In the navigation pane, expand Management Service, and then click SDXTools Files.
2. In the details pane, from the Action list, select Upload.

3. In the Upload SDXTools Files dialog box, click Browse, navigate to the folder that contains the file, and then double-click the file.
4. Click Upload.

To upgrade SDXTools:

On the Configuration tab, expand BlueCat DNS/DHCP.

1. Click Instances.
2. In the details pane, select an instance.
3. From the Action list, select Upgrade SDXTools.
4. In the Upgrade SDXTools dialog box, select a file, click OK, and then click Close.

Rediscovering a BlueCat DNS/DHCP Instance

You can rediscover an instance to view the latest state and configuration of an instance. During re-discovery, the Management Service fetches the configuration. By default, the Management Service schedules instances for rediscovery of all instances once every 30 minutes.

On the Configuration tab, expand BlueCat DNS/DHCP.

1. Click Instances.
2. In the details pane, select the instance that you want to rediscover, and from the Action list, click Rediscover.
3. In the Confirm message box, click Yes.

CA Access Gateway

September 27, 2025

CA Access Gateway is a scalable, manageable, and extensible stand-alone server that provides a proxy-based solution for access control. CA Access Gateway employs a proxy engine that provides a network gateway for the enterprise and supports multiple session schemes that do not rely on traditional cookie-based technology.

The embedded web agent enables Single Sign-On (SSO) across an enterprise. CA Access Gateway provides access control for HTTP and HTTPS requests and cookieless SSO. Also, the product stores session information in the in-memory session store. Proxy rules define how the CA Access Gateway forwards or redirects requests to resources located on destination servers within the enterprise.

By providing a single gateway for network resources, CA Access Gateway separates the corporate network and centralizes access control.

Note:

SR-IOV interfaces (1/x and 10/x) that are part of a channel do not appear in the list of interfaces because channels are not supported on a CA Access Gateway instance. For more information about the features of CA Access Gateway, see the documentation for that product.

Provisioning a CA Access Gateway Instance

Before you can provision a CA Access Gateway instance, you must download an XVA image. After you have downloaded the XVA image, upload it to the SDX appliance. Make sure you are using Management Service version 10.5 build 52.3.e or later on the SDX appliance. To provision a CA Access Gateway, first you need to upload the XVA image to the SDX appliance and then provision an instance.

To upload an XVA image to the SDX appliance:

1. On the **Configuration** tab, navigate to **CA Access Gateway > Software Images**.
2. In the details pane, under **XVA Files**, from the **Action** drop-down list, click **Upload**.
3. In the dialog box that appears, click **Browse**, and then select the XVA file that you want to upload.
4. Click **Upload**. The XVA file appears in the **XVA Files** pane.

To provision a CA Access Gateway instance:

1. On the **Configuration** tab, navigate to **CA Access Gateway > Instances**.
2. In the details pane, click **Add**.
3. In the Provision CA Access Gateway wizard, follow the instructions on the screen.
4. Click **Finish**, and then click **Close**.

After you provision the instance, log on to the instance and perform the detailed configuration.

To modify the values of the parameters of a provisioned instance, in the details pane, select the instance that you want to modify, and then click **Modify**. In the Modify CA Access Gateway wizard, set the parameters to values suitable for your environment.

Note:

If you modify any of the interface parameters or the name of the instance, the instance stops and restarts to put the change into effect.

Monitoring a CA Access Gateway Instance

The SDX appliance collects statistics, such as the version of SDXTools running on the instance, of a CA Access Gateway instance.

To view the statistics related to a CA Access Gateway instance:

1. Navigate to CA Access Gateway > Instances.
2. In the details pane, click the arrow next to the name of the instance.

Managing a CA Access Gateway Instance

You can start, stop, restart, force stop, or force restart a CA Access Gateway instance from the Management Service. To complete these tasks, follow these steps:

1. On the Configuration tab, expand CA Access Gateway.
2. Navigate to CA Access Gateway > Instances.
3. In the details pane, select the instance on which you want to perform the operation, and then select one of the following options:
 - Start
 - Shut Down
 - Reboot
 - Force Shutdown
 - Force Reboot
4. In the Confirm message box, click Yes.

Palo Alto Networks VM-Series

September 27, 2025

Note:

Provisioning Palo Alto VM-Series instances on a NetScaler SDX appliance is supported only on the SDX platforms 115XX, 84XX, 221XX, and 215XX.

Palo Alto Networks VM-Series virtual firewalls use the same PAN-OS feature set that is available in the company's physical security appliances, providing all key network security functions. VM-Series on NetScaler SDX enables consolidation of advanced security and ADC capabilities on a single platform, for secure, reliable access to applications by businesses, business units, and service-provider customers. The combination of VM-Series on NetScaler SDX also provides a complete, validated, security, and ADC solution for Citrix Virtual Apps and Desktops deployments.

You can provision, monitor, manage, and troubleshoot an instance from the Management Service.

Points to note:

- The total number of instances that you can provision on an SDX appliance depends on the SDX hardware resources available.

- SR-IOV interfaces (1/x and 10/x) that are part of a channel do not appear in the list of interfaces because channels are not supported on a Websense protector instance. For more information about Palo Alto Network VM-Series, see [Palo Alto Network Documentation](#).

Provisioning a PaloAlto VM-Series Instance

Before you can provision a Palo Alto VM-Series instance, you must download an XVA image from the [Palo Alto Networks website](#). After you have downloaded the XVA image, upload it to the SDX appliance.

To upload an XVA image to the SDX appliance:

1. On the **Configuration** tab, navigate to **PaloAlto VM-Series > Software Images**.
2. In the details pane, under **XVA Files**, from the **Action** drop-down list, click **Upload**.
3. In the dialog box that appears, click **Browse**, and then select the XVA file that you want to upload.
4. Click **Upload**. The XVA file appears in the **XVA Files** pane.

To provision a Palo Alto VM-Series instance:

1. On the **Configuration** tab, navigate to **PaloAlto VM-Series > Instances**.
2. In the details pane, click **Add**.
3. In the Provision PaloAlto VM-Series wizard, follow the instructions on the screen.
4. Click **Finish**, and then click **Close**.

After you provision the instance, log on to the instance and perform the detailed configuration.

To modify the values of the parameters of a provisioned instance, in the details pane, select the instance that you want to modify, and then click **Modify**. In the Modify PaloAlto VM-Series wizard, set the parameters to values suitable for your environment.

Note:

If you modify any of the interface parameters or the name of the instance, the instance stops and restarts to put the change into effect.

Monitoring a Palo Alto VM-Series Instance

The SDX appliance collects statistics, such as the version of SDXTools running on the instance, of a Palo Alto VM-Series instance.

To view the statistics related to a Palo Alto VM-Series instance:

1. Navigate to PaloAlto VM-Series > Instances.
2. In the details pane, click the arrow next to the name of the instance.

Managing a PaloAlto VM-Series Instance

You can start, stop, restart, force stop, or force restart a PaloAlto VM-Series instance from the Management Service.

On the **Configuration** tab, expand PaloAlto VM-Series.

1. Navigate to PaloAlto VM-Series > Instances.
2. In the details pane, select the instance on which you want to perform the operation, and then select one of the following options:
 - Start
 - Shut Down
 - Reboot
 - Force Shutdown
 - Force Reboot
3. In the Confirm message box, click Yes.

Troubleshooting a PaloAlto VM-Series Instance

You can ping a PaloAlto VM-Series instance from the Management Service to check whether the device is reachable. You can trace the route of a packet from the Management Service to an instance to determine the number of hops involved in reaching the instance.

You can rediscover an instance to view the latest state and configuration of an instance. During rediscovery, the Management Service fetches the configuration and the version of the PaloAlto VM-Series running on the SDX appliance. By default, the Management Service schedules instances for rediscovery once every 30 minutes.

On the **Configuration** tab, expand **PaloAlto VM-Series**.

To Ping an instance:

1. Click **Instances**.
2. In the details pane, select the instance that you want to ping, and from the Action list, click Ping. The Pingmessage box shows whether the ping is successful.

To Trace the route an instance:

1. Click **Instances**.
2. In the details pane, select the instance that you want to ping, and from the Action list, click **TraceRoute**. The **Traceroute** message box displays the route to the instance.

To rediscover an instance:

1. Click **Instances**.
2. In the details pane, select the instance that you want to rediscover, and from the Action list, click **Rediscover**.
3. In the Confirm message box, click **Yes**.

Deploying a Citrix Secure Web Gateway™ Instance on an SDX Appliance

September 27, 2025

The Secure Web Gateway (SWG) solution offers tools that enterprises can use to protect against internet threats.

From release 12.0 56.20, you can deploy a SDX SWG instance on a SDX appliance. All SDX models support SDX SWG instances. For more information, see [SDX Hardware-Software Compatibility Matrix](#).

Deploying a SDX SWG instance on a SDX appliance includes the following tasks:

- Installing the hardware: ensure the SDX hardware is properly installed. For more information, see [Installing the Hardware](#).
- Setting up and configuring the SDX Management Service. For more information, see [Getting Started with the Management Service User Interface](#) and [Configuring the Management Service](#).
- Provisioning the SDX SWG instance on the SDX appliance. For more information, see [Provisioning Citrix ADC instances](#).
- Configuring the SDX SWG instance. For more information, see the [Citrix Secure Web Gateway](#) documentations.

Prerequisites

- Install an exclusive instance pack for SDX SWG. This instance pack is different from SDX platform license or SDX instance pack.

Points to Note

Keeping the following points in mind while provisioning a SDX instance on an SDX appliance:

- The platform license determines the throughput of the SDX SWG instance.
- You can provision the SWG instance only on one or more dedicated CPU cores.
- Use regular Citrix® ADC XVA and upgrade images for provisioning and upgrading an SDX SWG instance. Make sure the image supports the SWG feature.
- You can provision up to two SWG instances with one SDX 2-Instance Add-On Pack for Secure Web Gateway license.

Limitations

- You cannot convert a NetScaler VPX ADC instance to a SWG instance, and vice versa.
- You cannot set up a Citrix ADC cluster of SDX SWG instances.
- Attaching a FIPS partition to an SDX SWG instance is not supported.
- Pooled licensing is not supported.

Deploy a Citrix SD-WAN VPX instance on a NetScaler SDX appliance

September 27, 2025

Citrix SD-WAN technology applies software-defined networking (SDN) concepts to WAN connections. The technology abstracts traffic management and monitoring from network hardware and applies them to individual applications. The result is improved performance, high-quality user experiences over geographically dispersed locations, and simplified deployment of wide-area and cloud-access networks. For more information, see [Citrix SD-WAN](#).

From release 12.1 49.xx, you can deploy a Citrix SD-WAN VPX instance on NetScaler SDX 14XXX and SDX 115XX appliances. For more information, see the following documents:

- [NetScaler SDX 14020, SDX 14030, SDX 14040, SDX 14060, SDX 14080, and SDX 14100](#)
- [NetScaler SDX 11515, SDX 11520, SDX 11530, SDX 11540, and SDX 11542](#)

Note: Only SD-WAN VPX Standard edition is supported. For more information, see [SD-WAN VPX editions](#).

Deploying a Citrix SD-WAN™ VPX instance on an SDX appliance includes the following tasks:

- Installing the hardware: ensure the SDX hardware is properly installed. For more information, see [Installing the Hardware](#).
- Setting up and configuring the SDX Management Service. For more information, see [Getting Started with the Management Service User Interface](#) and [Configuring the Management Service](#).
- Provisioning the SD-WAN VPX instance on the SDX appliance. For more information, see Provision the Citrix SD-WAN VPX instance on a NetScaler SDX.
- Configuring the SD-WAN VPX instance. For more information, see the [Configuration](#) documents and [Configuring the virtual path service between the MCN and client sites](#).

Prerequisites

Ensure you've the following licenses:

- Citrix SD-WAN VPX license
- NetScaler SDX platform license

Citrix SD-WAN VPX requirements

The Citrix SD-WAN VPX on SDX platform can act both as a site and MCN. The MCN can handle 1 Gb/s bidirectional throughput and 64 sites.

Supported throughput for MCN and site

- 250 Mb/s to 1 Gb/s bidirectional throughput
- MCN supports 64 sites

Hardware requirement for supported throughput Site

- 4 CPUs to 16 CPUs
- 4 GB to 16 GB RAM
- 60 GB to 250 GB disk storage
- Minimum 4 NICs: one for management and remaining minimum 3 for data path

Master control node (MCN)

- 4, 8, and 16 CPUs
- 16 GB RAM
- 250 GB disk storage
- Minimum 4 NICs: one for management and remaining 3 for data path, with dedicated NICs for data path

Data center topology

You can deploy a Citrix SD-WAN VPX appliance on a NetScaler SDX in policy-based route (PBR) mode or in inline mode. See scenario 1 and 2 for topologies for these two supported modes. For more information, see [Deploying SD-WAN in virtual inline mode](#).

Scenario 1. Data center topology: PBR mode or virtual inline mode

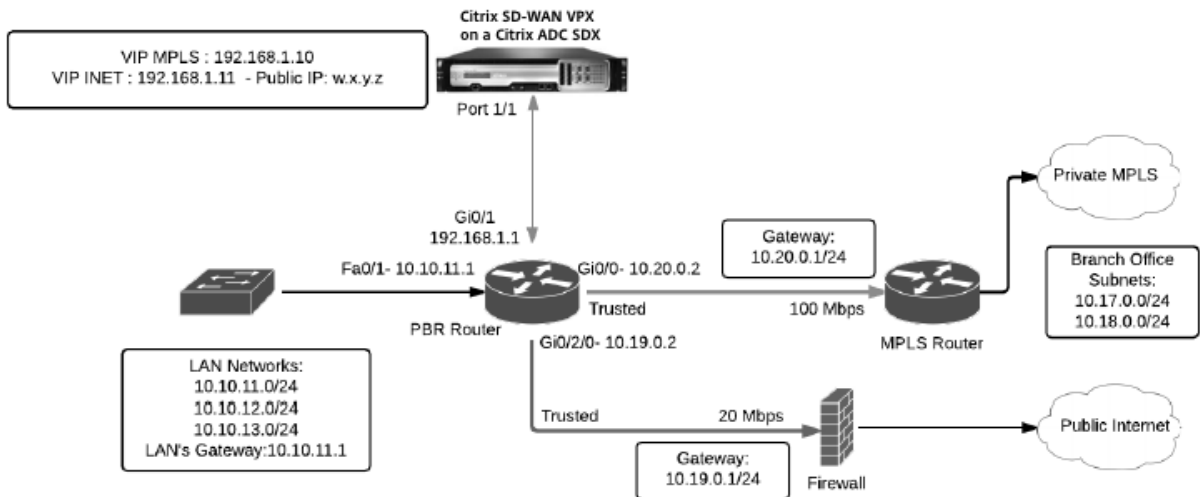

Scenario 2. Branch topology: Inline mode

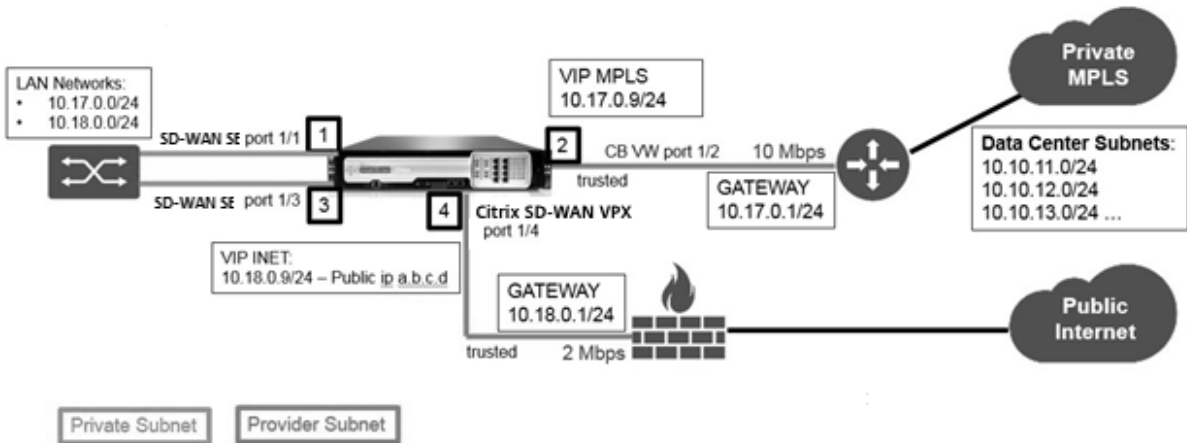

Provision the Citrix SD-WAN VPX instance on a NetScaler SDX™

Before you provision the Citrix SD-WAN VPX appliance, download the SD-WAN VPX image from the Citrix® product download site:

<https://www.citrix.com/downloads/netscaler-sd-wan/>.

Follow these steps to provision the Citrix SD-WAN VPX appliance.

1. Log on to the NetScaler SDX appliance.
2. Navigate to **Configuration > SD-WAN > Instances**.
3. Select **Software Images > Upload** and upload the SD-WAN XVA file.



4. Select **Instances > Add**. The **Provision SD-WAN Instance** page appears.

5. In the Provision SD-WAN Instance page, enter the following:

- a. Name
- b. IP address
- c. Netmask
- d. Gateway address
- e. Upload the XVA file
- f. Under **Resource Allocation**, allocate resources.

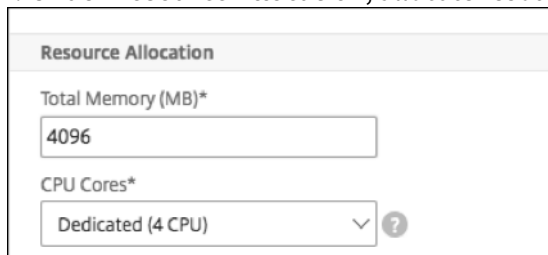

g. Under **Network Settings**, provision management interfaces and select **OK** to create to provision the SD-WAN VPX instance on the SDX appliance.

Note: The SDX Management Service binds interfaces to the VPX instance in ascending sequence of interface names. For example, if you add 1/4, and 1/1, Management Service arranges them as 1/1, 1/4.

When you add new interfaces, the existing sequence is retained and a new sequence is created. For example, you add interfaces 1/2, 10/1, 1/3. The new sequence would be 1/1, 1/4; 1/2, 1/3, 10/1.

6. The SD-WAN VPX instance appears under the **Instance page**. Here's an example.

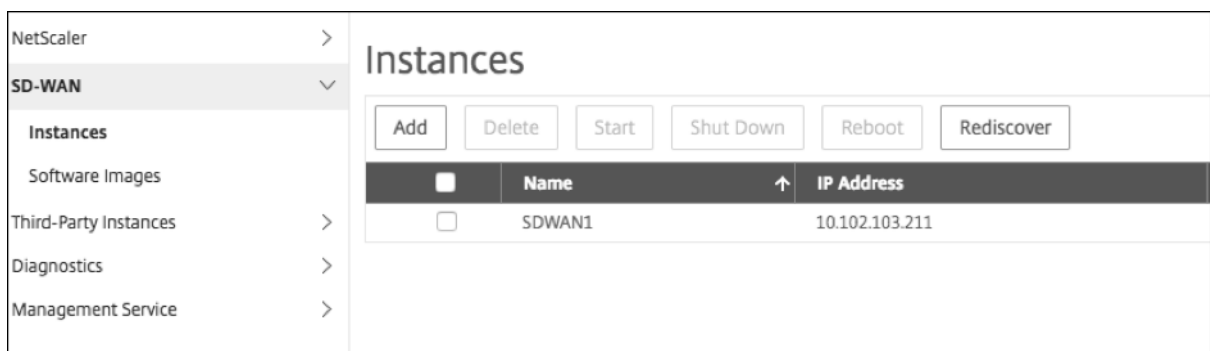

To edit the instance, navigate to **Configuration > SD-WAN > Instances**. Select and click the instance. Once you've completed editing, click **OK** to save the changes.

Configuring the Citrix SD-WAN VPX instance

After you've created an SD-WAN instance on the SDX appliance, configure the SD-WAN instance by completing these two tasks:

1. Apply configuration for both MCN and site appliances.
2. Configure virtual path and transmit traffic.

For more information, see the following topics:

- [Configuration](#)
- [Configuring the virtual path service between the MCN and client sites](#)

Related information

For more information about getting started with a Citrix SD-WAN appliance, see [Citrix SD-WAN](#).

For more about NetScaler SDX appliance, see [NetScaler SDX](#).

Bandwidth Metering in SDX

September 27, 2025

NetScaler SDX bandwidth metering provides you with an accurate, reliable, and easy-to-use metering scheme that lets you efficiently allocate processing capacity and monetize bandwidth usage. A metering scheme is required to optimally allocate the bandwidth among various resources, keeping in mind that all the users at all the times get the allocated bandwidth.

The bandwidth allocation can be done in the following two modes:

- Dedicated bandwidth with a fixed rate of throughput
- Dedicated bandwidth with minimum assured throughput and bandwidth bursting ability

Dedicated bandwidth with a fixed rate of throughput

In the bandwidth allocation method, each VPX instance is assigned a dedicated bandwidth. The instance is allowed to use the bandwidth up to the limit set. In dedicated mode the minimum and maximum bandwidth allocated are the same. If during a period, the VPX instance requires more bandwidth

than allocated, then in the dedicated mode the instance cannot increase its throughput. This can be a downside if a VPX instance serves critical requests.

Also, if an SDX appliance has a few VPX instances and some of them are not utilizing their allocated bandwidth, then in dedicated mode it is not possible to share their unused bandwidth. To overcome all these challenges, a dedicated bandwidth with minimum assured rate with the ability to dynamically increase the bandwidth is useful.

Dedicated bandwidth with minimum assured throughput and bandwidth bursting ability

In this bandwidth allocation method, a VPX is allocated a minimum assured bandwidth with the flexibility to increase its bandwidth up to a preset limit. The extra bandwidth that a VPX can use is called burst capacity.

The benefit of burst capacity is that if some of VPX instances have unused extra capacity, that capacity can be allocated to other VPX instances that have fully utilized their allocated bandwidth and require more for some time. Various service providers are also interested in providing various add-on services to their customers that require dedicated capacity. At the same time they do not want to over provision bandwidth. Burstable bandwidth helps in such scenarios where the customers are assured of a specific bandwidth with the option to increase the bandwidth during high demand periods.

Selecting the bandwidth allocation mode

Before you choose burstable throughput, you need to enable dynamic burst throughput allocation. To enable this option, follow these steps.

1. From the SDX Management Console, navigate to **Configuration > System**.
2. From the **System Settings** group, select **Change System Settings**.
3. Click the **Enable Dynamic Burst Throughput Allocation** check box to enable dynamic throughput.

Dashboard

Configuration

Documentation

Downloads

← Configure System Settings

Communication with Citrix ADC Instance*

https

Secure Access Only

Enable Session Timeout

Enable Dynamic Burst Throughput Allocation

Allow Basic Authentication

Enable nsrecover Login

Enable Shell access for non-nsroot User

OK Close

When you provision a VPX, you can select from bandwidth burst or dynamic throughput.

1. In the **SDX Management Service**, click **Configuration > Citrix® ADC > Instances > Add**.
2. The **Provision Citrix ADC** page opens. Under **License Allocation**, choose **Burstable** from **Allocation Mode**.

License Allocation

Feature License*
Standard

For more information about Citrix ADC editions, see Citrix ADC Editions

Pool	Total	Available	Allocate
Instance	25	0	1
Bandwidth	100 Gbps	20 Gbps	Allocation Mode* Burstable
			Min (Mbps)* 1000
			Max (Mbps) 0
			Burst* P0

For more information about how to provision a Citrix ADC instance, see [Provisioning Citrix ADC instances](#).

If you want to use fixed rate of throughput, select **Fixed**. By default, fixed mode is set for bandwidth allocation. It is not necessary that all the VPX instances work in the same mode. Each VPX instance can be configured in different mode.

Note: If you are migrating SDX from 10.5.e and previous version, by default all the VPX instances are in the fixed allocation mode.

Determining the maximum burst bandwidth for a VPX instance

The extent to which each VPX is allowed to burst is computed through an algorithm. When you provision a VPX with burstable bandwidth, then each such VPX has to be given a priority. The allocation of burstable bandwidth depends on this burst priority. The priority varies from P0 to P4 with P0 being the highest priority and P4 being the lowest.

Let us take a case where there are 2 VPX, namely VPX1 and VPX2. The minimum bandwidth allocated to VPX1 and VPX2 is 4 Gbps and 2 Gbps respectively with a burstable bandwidth of 2 Gbps and 1 Gbps each. The following table depicts the parameters:

VPX Name	Parameter	Value
VPX1	Minimum assured bandwidth	4Gbps
-	-	Maximum Burstable bandwidth
-	-	2Gbps
-	-	Priority
-	-	P0
VPX2	Minimum assured bandwidth	2Gbps
-	-	Maximum Burstable bandwidth
-	-	1Gbps
-	-	Priority
-	-	P1

In this case, let us assume that the total licensed bandwidth is 8 Gbps. If both the VPX instances are bursting to their maximum burstable limits, that is:

1. VPX1 is using its maximum burstable bandwidth, that is 2 Gbps then it is using a total of $4 + 2 = 6$ Gbps
2. VPX2 is using its maximum burstable bandwidth, that is 1 Gbps then it is using a total of $2 + 1 = 3$ Gbps

In this case the maximum bandwidth that is used is more than the licensed capacity of 8 Gbps. So to bring down the usage to a bandwidth within the licensed capacity, one of the VPX would have to give up its burstable bandwidth. In this case since VPX2 has lower priority than VPX1, so it gives up its 1 Gbps burstable bandwidth. VPX1 would continue to burst as it has higher priority than VPX2. In all such scenarios, it is made sure that the minimum guaranteed bandwidth is always honored.

Checking the throughput and data consumption statistics

You can check individual VPX's throughput and data consumption statistics in graphs. To access the graphs, follow these steps:

1. From the SDX Management Service, go to **Configuration > Citrix ADC > Instances** page.
2. Select a VPX instance and then click the **Action drop** list.
3. From the list select either **Throughput Statistics** or **Data Usage Statistics**.

The graphs provide you to check the data consumption and throughput statistics for various periods of time, like:

- Last 1 hour
- Last 1 day
- Last 1 week
- Last 1 month, and
- Previous month

You can also select a specific time period in the graph by adjusting the slider at the bottom of the graph. Move your mouse over the lines in the graph to check the data consumption or throughput data for a specific time.

The following illustration shows a sample graph of throughput data for 1 week:

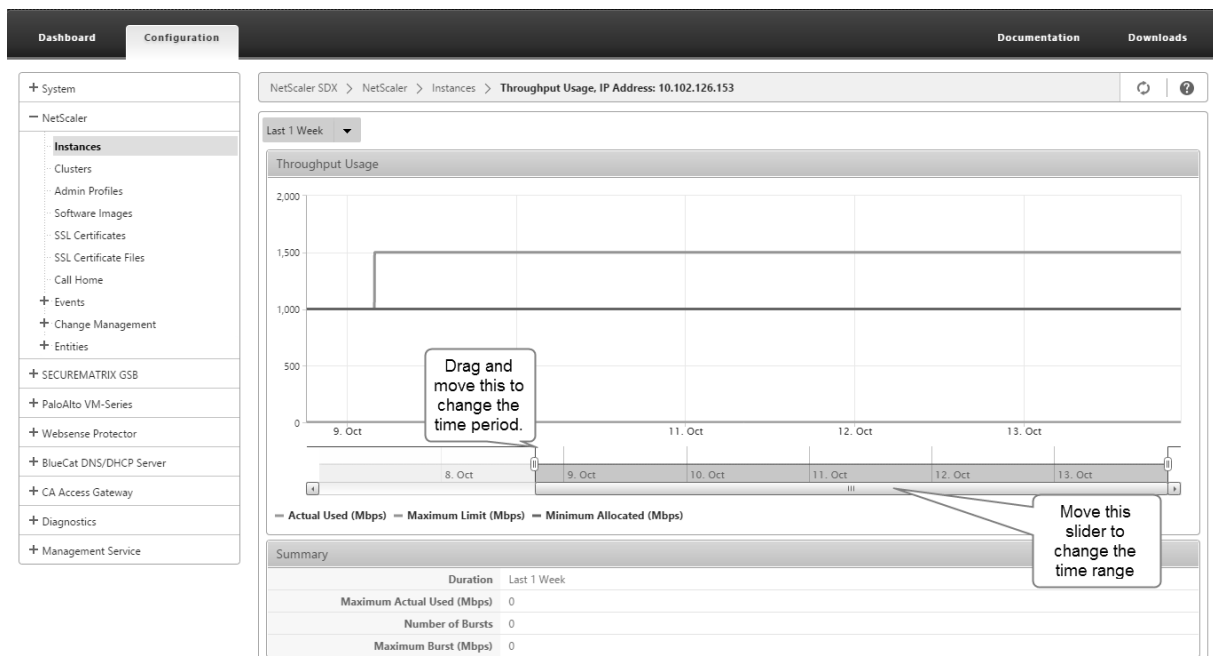

Configuring and Managing Citrix® ADC instances

September 27, 2025

After you have provisioned Citrix ADC instances on your appliance, you are ready to configure and manage the instances. Begin by creating a subnet IP (SNIP) address and then saving the configuration. You can then perform basic management tasks on the instances. Check to see if you have to apply the administration configuration.

If a task that you need to perform is not described below, see the list of tasks at the left.

Warning:

Make sure that you modify the provisioned network interfaces or VLANs of an instance using the Management Service instead of performing the modifications directly on the instance.

Creating a SNIP Address on a Citrix ADC instance

You can assign a SNIP address to the Citrix ADC instances after it is provisioned on the SDX appliance.

A SNIP is used in connection management and server monitoring. It is not mandatory to specify a SNIP when you initially configure the NetScaler SDX appliance. You can assign SNIP to the Citrix ADC instance from the Management Service.

To add a SNIP Address on a Citrix ADC instance

1. On the Configuration tab, in the navigation pane, click Citrix ADC.
2. In the details pane, under Citrix ADC Configuration, click Create IP.
3. In the Create Citrix ADC IP dialog box, specify values for the following parameters.
 - IP Address: specify the IP address assigned as the SNIP address.
 - Netmask: specify the subnet mask associated with the SNIP address.
 - Type: By default the value is SNIP.
 - Save Configuration: Specify whether the configuration should be saved on the Citrix ADC. Default value is false.
 - Instance IP Address: Specify the IP address of the Citrix ADC instance.
4. Click Create, and then click Close.

Saving the Configuration

You can save the running configuration of a Citrix ADC instance from the Management Service.

To save the configuration on a Citrix ADC instance

1. On the Configuration tab, in the navigation pane, click Citrix ADC.
2. In the details pane, under Citrix ADC Configuration, click Save Configuration.
3. In the Save Configuration dialog box, in Instance IP Address, select the IP addresses of the Citrix ADC instances whose configuration you want to save.
4. Click OK, and then click Close.

Managing a Citrix ADC instance

The Management Service lets you perform the following operations on the Citrix ADC instances, both from the Citrix ADC instances pane in the Configuration tab and in the Citrix ADC instances gadget on the Home page.

Start a Citrix ADC instance:

Start any Citrix ADC instance from the Management Service user interface. When the Management Service UI forwards this request to the Management Service, it starts the Citrix ADC instance.

Shut down a Citrix ADC instance:

Shut down any Citrix ADC instance from the Management Service user interface. When the Management Service UI forwards this request to the Management Service, it stops the Citrix ADC instance.

Reboot a Citrix ADC instance:

Restart the Citrix ADC instance.

Delete a Citrix ADC instance:

If you do not want to use a Citrix ADC instance, you can delete that instance by using the Management Service. Deleting an instance permanently removes the instance and its related details from the database of the SDX appliance.

To start, stop, delete, or restart a Citrix ADC instance

1. On the Configuration tab, in the navigation pane, click Citrix ADC instances.
2. In the Citrix ADC instances pane, select the Citrix ADC instance on which you want to perform the operation, and then click Start or Shut Down or Delete or Reboot.
3. In the Confirm message box, click Yes.

Removing Citrix ADC instance Files

You can remove any Citrix ADC instance files, such as XVAs, builds, documentation, SSL keys or SSL certificates, from the appliance.

To remove Citrix ADC instance files

1. On the Configuration tab, in the navigation pane, expand Citrix ADC Configuration, and then click the file that you want to remove.
2. In the details pane, select the file name, and then click Delete.

Applying the Administration Configuration

At the time of provisioning a VPX instance, the Management Service creates some policies, instance administration (admin) profile, and other configuration on the VPX instance. If the Management Service fails to apply the admin configuration at this time due to any reason (for example, the Management Service and the VPX instance are on different subnetworks and the router is down or if the Management Service and VPX instance are on the same subnet but traffic has to pass through an external switch and one of the required links is down), you can explicitly push the admin configuration from the Management Service to the VPX instance at any time.

To apply the admin configuration on a Citrix ADC instance

1. On the Configuration tab, in the navigation pane, click Citrix ADC.
2. In the details pane, under Citrix ADC Configuration, click Apply Admin Configuration.
3. In the Apply Admin Configuration dialog box, in Instance IP Address, select the IP address of the VPX instance on which you want to apply the admin configuration.
4. Click OK.

Installing and Managing SSL Certificates

September 27, 2025

The process of installing SSL certificates involves uploading the certificate and key files to the NetScaler SDX appliance, and then installing the SSL certificate on the Citrix ADC instances.

Uploading the Certificate File to the SDX Appliance

For any SSL transaction, the server needs a valid certificate and the corresponding private and public key pair. The certificate file must be present on the SDX appliance when you install the SSL certificate on the Citrix® ADC instances. You can also download the SSL Certificate files to a local computer as a backup.

In the SSL Certificates pane, you can view the following details.

- **Name**

The name of the certificate file.

- **Last Modified**

The date when the certificate file was last modified.

- **Size**

The size of the certificate file in bytes.

To upload SSL certificate files to the SDX appliance

1. In the navigation pane, expand Management Service, and then click SSL Certificate Files.
2. In the SSL Certificates pane, click Upload.
3. In the Upload SSL Certificate dialog box, click Browse and select the certificate file you want to upload.
4. Click Upload. The certificate file appears in the SSL Certificates pane.

To create a backup by downloading an SSL certificate file

1. In the SSL Certificates pane, select the file that you want to download, and then click Download.
2. In the message box, from the Save list, select Save as.
3. In the Save As message box, browse to the location where you want to save the file, and then click Save.

Uploading SSL Key Files to the SDX Appliance

For any SSL transaction, the server needs a valid certificate and the corresponding private and public key pair. The key file must be present on the SDX appliance when you install the SSL certificate on the Citrix ADC instances. You can also download the SSL key files to a local computer as a backup.

In the SSL Keys pane, you can view the following details.

- **Name**

The name of the key file.

- **Last Modified**

The date when the key file was last modified.

- **Size**

The size of the key file in bytes.

To upload SSL key files to the SDX appliance

1. In the navigation pane, expand Management Service, and then click SSL Certificate Files.
2. In the SSL Certificate pane, on the SSL Keys tab, click Upload.
3. In the Upload SSL Key File dialog box, click Browse and select the key file you want to upload.
4. Click Upload to upload the key file to the SDX appliance. The key file appears in the SSL Keys pane.

To create a backup by downloading an SSL key file

1. In the SSL Certificate pane, on the SSL Keys tab, select the file that you want to download, and then click Download.
2. In the message box, from the Save list, select Save as.
3. In the Save As message box, browse to the location where you want to save the file, and then click Save.

Installing an SSL Certificate on a Citrix ADC instance

The Management Service lets you install SSL certificates on one or more Citrix ADC instances. Before you begin installing the SSL certificate, make sure that you have uploaded the SSL certificate and key files to the SDX appliance.

To install SSL certificates on a Citrix ADC instance

1. In the navigation pane, click Citrix ADC.
2. In the details pane, under Citrix ADC Configuration, click Install SSL Certificates.
3. In the Install SSL Certificates dialog box, specify values for the following parameters. (*) indicates required fields.

- **Certificate File:** specify the file name of the valid certificate. The certificate file must be present on the SDX appliance.
- **Key File:** specify the file name of the private-key used to create the certificate. The key file must be present on the SDX appliance.
- **Certificate Name:** specify the name of the certificate-key pair to be added to the Citrix ADC. Maximum length: 31
- **Certificate Format:** specify the format of the SSL certificate supported on the Citrix ADC. A NetScaler SDX appliance supports the PEM and DER formats for SSL certificates.
- **Password:** Specify the pass-phrase that was used to encrypt the private-key. This option can be used to load encrypted private-keys. Max length: 32.
Note: Password protected private key is supported only for the PEM format.
- **Save Configuration:** specify whether the configuration needs to be saved on the Citrix ADC. Default value is false.
- **Instance IP Address:** specify the IP addresses of the Citrix ADC instances on which you want to install the SSL certificate.

4. Click OK, and then click Close.

Updating an SSL Certificate on a Citrix ADC instance

You can update some parameters, such as the certificate file, key file, and certificate format of an SSL certificate that is installed on a Citrix ADC instance. You cannot modify the IP address and certificate name.

To update the SSL certificate on a Citrix ADC instance

1. In the navigation pane, expand Citrix ADC, and then click SSL Certificates.
2. In the SSL Certificates pane, click Update.
3. In the Modify SSL Certificate dialog box, set the following parameters:
 - **Certificate File:** the file name of the valid certificate. The certificate file must be present on the SDX appliance.
 - **Key File:** the file name of the private-key used to create the certificate. The key file must be present on the SDX appliance.
 - **Certificate Format:** the format of the SSL certificate supported on the NetScaler SDX appliance. The appliance supports the PEM and DER formats for SSL certificates.

- Password: the pass-phrase that was used to encrypt the private-key. This option can be used to load encrypted private-keys. Maximum length: 32 characters.

Note: Password protected private key is supported only for the PEM format.

- Save Configuration: specify whether the configuration needs to be saved on the SDX appliance. Default value is false.
- No Domain Check: Do not check the domain name while updating the certificate.

4. Click OK, and then click Close.

Polling for SSL Certificates on the Citrix ADC instances

If you add a new SSL certificate directly on a Citrix ADC instance after logging on to that instance, the Management Service is not aware of this new certificate. To avoid this, specify a polling interval after which the Management Service will poll all the Citrix ADC instances to check for new SSL certificates. You can also perform a poll at any time from the Management Service if, for example, you want to immediately get a list of all the SSL certificates from all the Citrix ADC instances.

To configure a polling interval

1. In the navigation pane, expand Citrix ADC, and then click SSL Certificates.
2. In the SSL Certificates pane, click Configure Polling Interval.
3. In the Configure Polling Interval dialog box, set the following parameters:
 - Polling Interval: the time after which the Management Service polls the Citrix ADC instances.
 - Interval Unit: the unit of time. Possible values: Hours, Minutes. Default: Hours.
4. Click OK, and then click Close.

To perform an immediate poll

1. In the navigation pane, expand Citrix ADC, and then click SSL Certificates.
2. In the SSL Certificates pane, click Poll Now.
3. In the Confirm dialog box, click Yes. The SSL Certificates pane is refreshed and new certificates, if any, appear in the list.

Allowing L2 Mode on a Citrix® ADC instance

September 27, 2025

In Layer 2 (L2) mode, a Citrix ADC instance acts as a learning bridge and forwards all packets for which it is not the destination. Some features, such as Cloud Bridge, require that L2 mode be enabled on the Citrix ADC instance. With L2 mode enabled, the instance can receive and forward packets for MAC addresses other than its own MAC address. However, if a user wants to enable L2 mode on a Citrix ADC instance running on a NetScaler SDX appliance, the administrator must first allow L2 mode on that instance. If you allow L2 mode, you must take precautions to avoid bridging loops.

Precautions:

1. On a given 1/x interface, untagged packets must be allowed on only one instance. For all other instances enabled on the same interface, you must select Tagged.

Note:

Citrix recommends that you select Tagged for all interfaces assigned to instances in L2 mode. Note that if you select tagged, you cannot receive untagged packets on that interface.

If you have selected Tagged for an interface assigned to an instance, log on to that instance and configure a 802.1q VLAN to receive packets on that interface.

2. For 1/x and 10/x interfaces that are shared by Citrix ADC instances on which L2 mode is allowed, make sure that the following conditions are met:
 - VLAN filtering is enabled on all the interfaces.
 - Each interface is on a different 802.1q VLAN.
 - Only one instance can receive untagged packets on the interface. If that interface is assigned to other instances, you must select Tagged on that interface for those instances.
3. If you allow untagged packets for an instance on a 1/x interface, and L2 mode is allowed for that instance, no other instance (with L2 mode allowed or disallowed) can receive untagged packets on that interface.
4. If you allow untagged packets for an instance on a 1/x interface, and L2 mode is not allowed for that instance, no instance with L2 mode allowed can receive untagged packets on that interface.
5. If you have provisioned an instance (for example VPX1) in L2 mode on a 0/x interface, and the same interface is also assigned to another instance (for example VPX2), select Tagged for all other interfaces (1/x and 10/x) that are assigned to the second instance (VPX2).

Note: If L2 mode is enabled on a Citrix ADC instance, and both of the management interfaces (0/1 and 0/2) are associated with that instance, only one of the management interfaces can be associated with

another Citrix ADC instance on which L2 mode is enabled. You cannot associate both management interfaces with more than one Citrix ADC instance on which L2 mode is enabled.

To allow L2 mode on an instance

1. In the Provision ADC Wizard or the Modify ADC Wizard, on the Network Settings page, select Allow L2 Mode.
Note: You can activate the Allow L2 Mode setting on an instance when you provision the instance, or while the instance is running.
2. Follow the instructions in the wizard.
3. Click Finish, and then click Close.

Configuring VMACs on an Interface

September 27, 2025

A Citrix® ADC instance uses Virtual MACs (VMACs) for high availability (active-active or active-standby) configurations. A Virtual MAC address (VMAC) is a floating entity shared by the primary and the secondary nodes in a high availability setup.

In a high availability setup, the primary node owns all the floating IP addresses, such as the MIP, SNIP, and VIP addresses. The primary node responds to Address Resolution Protocol (ARP) requests for these IP addresses with its own MAC address. As a result, the ARP table of an external device (for example, an upstream router) is updated with the floating IP address and the primary node's MAC address.

When a failover occurs, the secondary node takes over as the new primary node. It then uses Gratuitous ARP (GARP) to advertise the floating IP addresses that it acquired from the primary. However, the MAC address that the new primary advertises is the MAC address of its own interface.

Some devices (notably a few routers) do not accept the GARP messages generated by the NetScaler SDX appliance. Such devices retain the old IP to MAC mapping advertised by the old primary node, and a site can go down as a result.

You can overcome this problem by configuring a VMAC on both nodes of an HA pair. Both nodes then possess identical MAC addresses. Therefore, when failover occurs, the MAC address of the secondary node remains unchanged, and the ARP tables on the external devices do not need to be updated.

Configuring a VMAC is a two-step process:

1. Configure VMAC on the SDX Management Service. You add a VRID for an interface or an LA channel. Configure VMAC on the SDX Management Service.
2. Configure VMAC on the Citrix instance. For information see the [Configure VMAC on Channel](#) group support article.

Configure VMAC on the SDX Management Service

To configure VMAC, add a IPv4 or IPv6 VRID to an interface or LA channel from the Management Service. The Management Service internally generates a VMAC. Specify the same VRID when you configure active-active mode on the Citrix ADC instance.

Keep the following points in mind:

1. Add a VRID from the Management Service and specify the same VRID in the Citrix ADC instance. If you add a VRID directly in the Citrix ADC instance, the instance cannot receive a packet that has a VMAC address as the destination MAC address.
2. You cannot use the same VRID on different instances running in the same SDX appliance.
3. You can add or delete the VRIDs for an interface assigned to an instance while the Instance is running.
4. In an active-active configuration, you can specify more than one VRID for an interface assigned to an instance.
5. A maximum of 86 VMACs are allowed on a 10G interface, and a maximum of 16 VMACs on a 1G interface. If no more VMAC filters are available, reduce the number of VRIDs on another instance.

You can add a VRID at the time of adding a NetScaler VPX instance, or you can modify an existing Citrix ADC instance to add a VRID.

To add an IPv4 or IPv6 VRID to an interface or LA channel

1. While adding a VPX instance on SDX, under **Network Settings**, select **Data Interfaces**. For more information about how to add a VPX instance on SDX, see [Add a Citrix ADC instance](#).
2. From the **Interfaces** drop-down menu, select the interface or the LA channel.
3. Under VMAC settings, and set one or both of the following values:
 - VRID IPv4—The IPv4 VRID that identifies the VMAC. Possible values: 1–255.
 - VRID IPv6—The IPv6 VRID that identifies the VMAC. Possible values: 1–255.

Note: Use a comma to separate multiple VRIDs. For example, 12,24.
4. Click **Add** to add the **VMAC** settings to the interface.
5. Click **Finish**, and then click **Close**.

Add Data Interface

Interfaces*

LA/1 (LACP) ▼

The option "Allow Untagged Traffic" needs to be always enabled on a

Allow Untagged Traffic

VLANs

100-110,142,151-155

MAC Address Mode*

Default ▼

▼ VMAC Settings (IPv4 and IPv6 VRIDs to configure Virtual MAC)

VRID IPv4

2,10,111

VRID IPv6

2,10,111

Add
Close

If the instance is already provisioned, to add an IPv4 or IPv6 VRID, follow these steps.

1. From the SDX Management Service, go to **Configuration > Citrix ADC > Instances**.
2. Select the instance and click **Edit**.
3. Under **Data Interfaces**, select the interface and click edit.
4. Under VMAC settings, set the VRID values. Click **Add** and then click **Done**.

Generating Partition MAC Addresses to Configure Admin Partition on a Citrix® ADC instance in the SDX Appliance

September 27, 2025

A Citrix ADC instance on a NetScaler SDX appliance can be partitioned into logical entities called admin

partitions. Each partition can be configured and used as a separate Citrix ADC instance. For more information about admin partitions, see [Admin Partitioning](#).

For using admin partitions with a shared VLAN configuration, you need a virtual MAC address for each partition. Such a virtual MAC address is called a partition MAC (PMAC) address, and it is used for classifying traffic received on a shared VLAN. This PMAC address is used across all the shared VLANs bound to that partition.

You must generate and configure the PMAC address by using the Management Service user interface, before using the admin partition. Management Service enables you to generate partition MAC addresses by:

- Using a base MAC address
- Specifying custom MAC addresses
- Randomly generating MAC addresses

Note

After generating the partition MAC addresses, you must restart the Citrix ADC instance before configuring the admin partitions.

To generate the partition MAC addresses by using a base MAC address:

1. On the **Configuration** tab, in the left pane, expand **Citrix ADC**, and then click **Instances**.
2. In the **Instances** pane, select the Citrix ADC instance for which you want to generate the partition MAC addresses.
3. In the **Action** drop-down list, click **Partition MACs**.
4. In the **Partition MACs** pane, click **Generate**.
5. In the **Generate Partition MACs** dialog box, in the **Generation Method** section, select **Using Base Address**.
6. In the **Base MAC Address** field, enter the base MAC address.
7. In the **Increment By** field, enter the value by which the base MAC address should be incremented for each subsequent MAC address.
For example, if you have specified the base MAC address as 00:A1:C9:11:C8:11 and the increment value as 2, the next MAC address is generated as 00:A1:C9:11:C8:13.
8. In the **Count** field, enter the number of partition MAC addresses you want to generate.
9. Click **Generate**.

To generate the partition MAC addresses by specifying custom MAC addresses:

1. On the **Configuration** tab, in the left pane, expand **Citrix ADC**, and then click **Instances**.
2. In the **Instances** pane, select the Citrix ADC instance for which you want to generate the partition MAC addresses.
3. In the **Action** drop-down list, click **Partition MACs**.
4. In the **Partition MACs** pane, click **Generate**.

5. In the **Generate Partition MACs** dialog box, in the **Generation Method** section, select **User Specified**.
6. In the **MAC Addresses** field, enter a MAC address.
7. Click the + icon, and then enter the next MAC address. Repeat to specify additional custom MAC addresses.
8. Click **Generate**.

To randomly generate the partition MAC addresses:

1. On the **Configuration** tab, in the left pane, expand **Citrix ADC**, and then click **Instances**.
2. In the **Instances** pane, select the Citrix ADC instance for which you want to generate the partition MAC addresses.
3. In the **Action** drop-down list, click **Partition MACs**.
4. In the **Partition MACs** pane, click **Generate**.
5. In the **Generate Partition MACs** dialog box, in the **Generation Method** section, select **Random**.
6. In the **Count** field, enter the number of partition MAC addresses you want to generate.
7. Click **Generate**.

After you have generated partition MAC addresses in SDX appliance, use the generated partition MAC addresses to configure admin partitions on the Citrix ADC instance.

Change Management for VPX Instances

September 27, 2025

You can track any changes to the configuration on a NetScaler VPX instance from the Management Service. The details pane lists the device name with IP address, date and time when it was last updated, and whether there is any difference between the saved configuration and the running configuration. Select a device to view its running configuration, saved configuration, history of configuration changes, and any difference between the configurations before and after an upgrade. You can download the configuration of a VPX instance to your local computer. By default, the Management Service polls all the instances every 24 hours, but you can change this interval. You can create an audit template by copying the commands from an existing configuration file. You can later use this template to find any changes in the configuration of an instance and take corrective action if required.

To view change management for VPX instances

1. On the Configuration tab, navigate to Citrix® ADC > Change Management.
2. In the Change Management pane, select a VPX instance, and then from the Action list, select one of the following:

- Running Configuration—Displays the running configuration of the selected VPX instance in a new window.
- Saved Configuration—Displays the saved configuration of the selected VPX instance in a new window.
- Saved Vs. Running Diff—Displays the saved configuration, the running configuration, and the corrective command (the difference).
- Revision History Diff—Displays the difference between the base configuration file and the second configuration file.
- Pre vs. Post Upgrade Diff—Displays the difference in the configuration before and after an upgrade, and the corrective command (the difference).
- Template Diff—Displays the difference between the saved or running configuration and the template. You can save this difference as a batch file. To apply the configuration from the template to the instance, apply this batch file to the instance.
- Download—Downloads the configuration of the selected VPX instance and saves it on a local device.

To poll for updates to the configuration of any of the Citrix ADC instances

1. On the Configuration tab, navigate to Citrix ADC > Change Management.
2. In the Change Management pane, from the Action list, select one of the following:
 - Poll Now—Management Service performs an immediate poll for updates to the configuration (ns.conf) of any of the VPX instances installed on the appliance.
 - Configure Polling Interval—Time after which the Management Service polls for updates to the configuration (ns.conf) of any of the VPX instances installed on the appliance. The default polling interval is 24 hours.

To configure an audit template for a Citrix ADC instance

1. Open an existing configuration file and copy its list of commands.
2. On the Configuration tab, navigate to Citrix ADC > Change Management > Audit Templates.
3. In the details pane, click Add.
4. In the Add Template dialog box, add a name and description for the template.
5. In the Command text box, paste the list of commands that you copied from the configuration file.
6. Click Create, and then click Close.

Monitoring Citrix® ADC instances

September 27, 2025

A high-level view of the performance of the appliance and the VPX instances provisioned on the appliance are displayed on the Monitoring page of the Management Service user interface. After provisioning and configuring the Citrix ADC instance, you can perform various tasks to monitor the Citrix ADC instance.

Viewing the properties of VPX instances

The Management Service user interface displays the list and description of all the VPX instances provisioned on the SDX appliance. Use the Citrix ADC instances pane to view details, such as the instance name and IP address, CPU and memory utilization, number of packets received and transmitted on the instance, the throughput and total memory assigned to the instance.

Clicking the IP address of the VPX instance opens the configuration utility (GUI) of that instance in a new tab or browser.

To view the properties of VPX instances

1. On the Configuration tab, in the left pane, expand Citrix ADC Configuration, and then click Instances.

Note: You can also view the properties of a VPX instance from the Home tab.

2. In the Citrix ADC instance pane, you can view the following details for the Citrix ADC instance:
 - Name
The host name assigned to the Citrix ADC instance while provisioning.
 - VM State
The state of the virtual machine.
 - Citrix ADC State
The state of the Citrix ADC instance.
 - IP Address
The IP address of the Citrix ADC instance. Clicking the IP address opens the GUI of this instance in a new tab or browser.

- Rx (Mbps)
The packets received on the Citrix ADC instance.
 - Tx (Mbps)
The packets transmitted by the Citrix ADC instance.
 - HTTP Req/s
The total number of HTTP requests received on the Citrix ADC instance every second.
 - CPU Usage (%)
The percentage of CPU utilization on the Citrix ADC.
 - Memory Usage (%)
The percentage of memory utilization on the Citrix ADC.
3. Click the arrow next to the name of a Citrix ADC instance to view the properties of that instance, or click Expand All to view the properties of all the Citrix ADC instances. You can view the following properties:
- Netmask
The netmask IP address of the Citrix ADC instance.
 - Gateway
The IP address of the default gateway, the router that forwards traffic outside of the subnet in which the instance is installed.
 - Packets per second
The total number of packets passing every second.
 - NICs
The names of the network interface cards used by the Citrix ADC instance, along with the virtual function assigned to each interface.
 - Version
The build version, build date, and time of the Citrix ADC software currently running on the instance.
 - Host Name
The host name of the Citrix ADC instance.
 - Total Memory (GB)
The total memory being assigned to the Citrix ADC instance.

- **Throughput (Mbps)**
The total throughput of the Citrix ADC instance.
- **Up Since**
The date and time since when the instance has been continuously in the UP state.
- **#SSL Chips**
The total number of SSL chips assigned to the instance.
- **Peer IP address**
The IP address of the peer of this Citrix ADC instance if it is in an HA setup.
- **Status**
The status of the operations being performed on a Citrix ADC instance, such as status of whether inventory from the instance is completed or whether reboot is in progress.
- **HA Master State**
The state of the device. The state indicates whether the instance is configured in a stand-alone or primary setup or is part of a high availability setup. In a high availability setup, the state also displays whether it is in primary or secondary mode.
- **HA Sync Status**
The mode of the HA sync status, such as enabled or disabled.
- **Description**
The description entered while provisioning the Citrix ADC instance.

Viewing the Running and Saved Configuration of a Citrix ADC instance

By using the Management Service you can view the currently running configuration of a Citrix ADC instance. You can also view the saved configuration of a Citrix ADC instance and the time when the configuration was saved.

To view the running and saved configuration of a Citrix ADC instance

1. On the Configuration tab, in the left pane, expand Citrix ADC Configuration, and then click Instances.
2. In the Citrix ADC instances pane, click the Citrix ADC instance for which you want to view the running or saved configuration.

3. To view the running configuration, click Running Configuration, and to view the saved configuration, click Saved Configuration.
4. In the Citrix ADC Running Config window or the Citrix ADC Saved Config window, you can view the running or saved configuration of the Citrix ADC instance.

Pinging a Citrix ADC instance

You can ping a Citrix ADC instance from the Management Service to check whether the device is reachable.

To ping a Citrix ADC instance

1. On the Configuration tab, in the left pane, expand Citrix ADC Configuration, and then click Instances.
2. In the Citrix ADC instances pane, click the Citrix ADC instance you want to ping, and then click Ping. In the Ping message box, you can view whether the ping is successful.

Tracing the Route of a Citrix ADC instance

You can trace the route of a packet from the Management Service to a Citrix ADC instance by determining the number of hops used to reach the instance.

To trace the route of a Citrix ADC instance

1. On the Configuration tab, in the left pane, expand Citrix ADC Configuration, and then click Instances.
2. In the Citrix ADC instances pane, click the Citrix ADC instance you want to trace, and then click TraceRoute. In the Traceroute message box, you can view the route to the Citrix ADC.

Rediscovering a Citrix ADC instance

You can rediscover a Citrix ADC instance when you need to view the latest state and configuration of a Citrix ADC instance.

During rediscovery, the Management Service fetches the configuration. By default, the Management Service schedules devices for rediscovery once every 30 minutes.

To rediscover a Citrix ADC instance

1. On the Configuration tab, in the left pane, expand Citrix ADC Configuration, and then click Instances.
2. In the Citrix ADC instances pane, click the Citrix ADC instance you want to rediscover, and then click Rediscover.
3. In the Confirm message box, click Yes.

Using Logs to Monitor Operations and Events

September 27, 2025

Use audit and task logs to monitor the operations performed on the Management Service and on the NetScaler SDX instances. You can also use the events log to track all events for tasks performed on the Management Service and the Citrix Hypervisor.

Viewing the audit logs

All operations performed by using the Management Service are logged in the appliance database. Use audit logs to view the operations that a Management Service user has performed, the date and time of each operation, and the success or failure status of the operation. You can also sort the details by user, operation, audit time, status, and so on by clicking the appropriate column heading.

Pagination is supported in the Audit Log pane. Select the number of records to display on a page. By default, 25 records are displayed on a page.

To view audit logs, follow these steps:

1. In the navigation pane, expand System, and then click Audit.
2. In the Audit Log pane, you can view the following details.
 - User Name: the Management Service user who has performed the operation.
 - IP Address: the IP address of the system on which the operation was performed.
 - Port: the port at which the system was running when the operation was performed.
 - Resource Type: the type of resource used to perform the operation, such as xen_vpx_image and login.
 - Resource Name: the name of the resource used to perform the operation, such as vpx_image_name and the user name used to log in.
 - Audit Time: the time when the audit log was generated.
 - Operation: the task that was performed, such as add, delete, and log out.

- Status: the status of the audit, such as Success or Failed.
 - Message: a message describing the cause of failure if the operation has failed and status of the task, such as Done, if the operation was successful.
3. To sort the logs by a particular field, click the heading of the column.

Viewing Task Logs

Use task logs to view and track tasks, such as upgrading instances and installing SSL certificates, that are executed by the Management Service on the Citrix® ADC instances. The task log lets you view whether a task is in progress or has failed or has succeeded.

Pagination is supported in the Task Log pane. Select the number of records to display on a page. By default, 25 records are displayed on a page.

To view the task log, follow these steps:

1. In the navigation pane, expand Diagnostics, and then click Task Log.
2. In the Task Log pane, you can view the following details.
 - Name: the name of the task that is being executed or has already been executed.
 - Status: the status of the task, such as In progress, Completed, or Failed.
 - Executed By: the Management Service user who has performed the operation.
 - Start Time: the time at which the task started.
 - End Time: the time at which the task ended.

Viewing Task Device Logs

Use task device logs to view and track tasks being performed on each SDX instance. The task device log lets you view whether a task is in progress or has failed or has succeeded. It also displays the IP address of the instance on which the task is performed.

To view the task device log, follow these steps:

1. In the navigation pane, expand Diagnostics, and then click Task Log.
2. In the Task Log pane, double-click the task to view the task device details.
3. In the Task Device Log pane, to sort the logs by a particular field, click the heading of the column.

Viewing Task Command Logs

Use task command logs to view the status of each command of a task executed on a Citrix ADC instance. The task command log lets you view whether a command has been successfully executed or has failed. It also displays the command that is executed and the reason why a command has failed.

To view the task command log, follow these steps:

1. In the navigation pane, expand Diagnostics, and then click Task Log.
2. In the Task Log pane, double-click the task to view the task device details.
3. In the Task Device Log pane, double-click the task to view the task command details.
4. In the Task Command Log pane, to sort the logs by a particular field, click the heading of the column.

Viewing Events

Use the Events pane in the Management Service user interface to monitor the events generated by the Management Service for tasks performed on the Management Service.

To view the events, follow these steps:

1. Navigate to **System > Events**.
2. In the Events pane, you can view the following details.
 - Severity: the severity of an event, which could be critical, major, minor, clear, and information.
 - Source: the IP address on which the event is generated.
 - Date: the date when the event is generated.
 - Category: the category of event, such as PolicyFailed and DeviceConfigChange.
 - Message: the message describing the event.
3. To sort the events by a particular field, click the heading of the column.

Use Cases for Citrix NetScaler SDX Appliances

September 27, 2025

For networking components (such as firewalls and Application Delivery Controllers), support for multi-tenancy has historically involved the ability to carve a single device into multiple logical partitions. This approach allows different sets of policies to be implemented for each tenant without the need for numerous, separate devices. Traditionally, however it is severely limited in terms of the degree of isolation that is achieved.

By design, the SDX appliance is not subject to the same limitations. In the SDX architecture, each instance runs as a separate virtual machine (VM) with its own dedicated Citrix ADC kernel, CPU resources, memory resources, address space, and bandwidth allocation. Network I/O on the SDX appliance not

only maintains aggregate system performance but also enables complete segregation of each tenant's data-plane and management-plane traffic. The management plane includes the 0/x interfaces. The data plane includes the 1/x and 10/x interfaces. A data plane can also be used as a management plane.

The primary use cases for an SDX appliance are related to consolidation, reducing the number of networks required while maintaining management isolation. Following are the basic consolidation scenarios:

- Consolidation when the Management Service and the Citrix® ADC instances are in the same network.
- Consolidation when the Management Service and the Citrix ADC instances are in different networks but all the instances are in the same network.
- Consolidation across security.
- Consolidation with dedicated interfaces for each instance.
- Consolidation with sharing of a physical port by more than one instance.

Consolidation When the Management Service and the Citrix® ADC instances are in the Same Network

September 27, 2025

A simple type of consolidation case on the SDX appliance is configuration of the Management Service and the Citrix ADC instances as part of the same network. This use case is applicable if the appliance administrator is also the instance administrator and your organization's compliance requirement does not specify that separate management networks are required for the Management Service and the NSIP addresses of the different instances. The instances can be provisioned in the same network (for management traffic), but the VIP addresses can be configured in different networks (for data traffic), and thus in different security zones.

In the following example, the Management Service and the Citrix ADC instances are part of the 10.1.1.x network. Interfaces 0/1 and 0/2 are the management interfaces, 1/1 to 1/8 are 1G data interfaces, and 10/1 to 10/4 are 10G data interfaces. Each instance has its own dedicated physical interface. Therefore, the number of instances is limited to the number of physical interfaces available on the appliance. By default, VLAN filtering is enabled on each interface of the SDX appliance, and that restricts the number of VLANs to 32 on a 1G interface and 63 on a 10G interface. VLAN filtering can be enabled and disabled for each interface. Disable VLAN filtering to configure up to 4096 VLANs per interface on each instance. In this example, VLAN filtering is not required because each instance has its own dedicated interface. For more information about VLAN filtering, see the **VLAN filtering** section in [Manage and monitor the SDX appliance](#).

The following figure illustrates the above use case.

Figure 1. Network topology of an SDX appliance with Management Service and NSIPs for instances in the same network

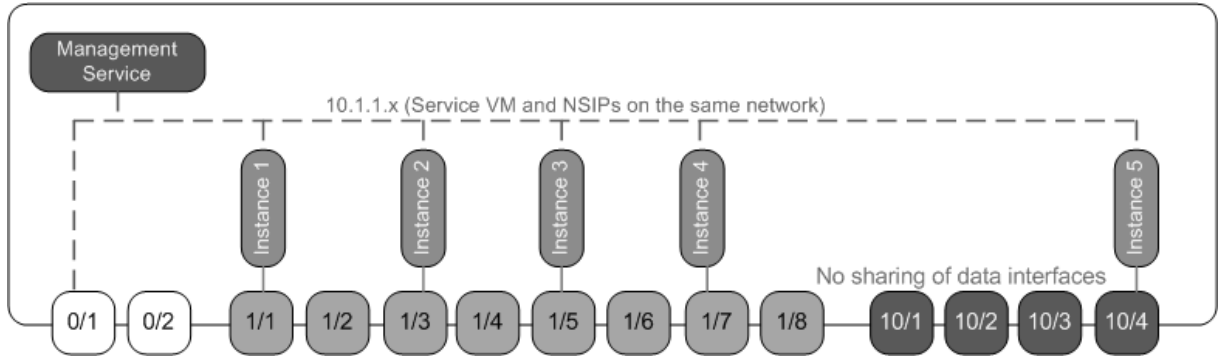

The following table lists the names and values of the parameters used for provisioning Citrix ADC instance 1 in the above example.

Parameter Name	Values for Instance 1
Name	vpx8
IP Address	10.1.1.2
Netmask	255.255.255.0
Gateway	10.1.1.1
XVA File	NS-VPX-XEN-10.0-51.308.a_nc.xva
Feature License	Platinum
Admin Profile	ns_nsroot_profile
User Name	vpx8
Password	Sdx
Confirm Password	Sdx
Shell/Sftp/Scp Access	True
Total Memory (MB)	2048
#SSL Chips	1
Throughput (Mbps)	1000
Packets per second	1000000
CPU	Shared
Interface	0/1 and 1/1

Provision Citrix ADC instance 1 as shown in this example

1. On the Configuration tab, in the navigation pane, expand Citrix ADC Configuration, and then click Instances.
2. In the Citrix ADC instances pane, click Add.
3. In the Provision Citrix Wizard follow the instructions in the wizard to specify the parameter values shown in the above table.
4. Click Create, and then click Close. The Citrix ADC instance you provisioned appears in the Citrix ADC instances pane.

Consolidation When the Management Service and the Citrix® ADC instances are in Different Networks

September 27, 2025

In certain cases, the appliance administrator might allow other administrators to perform administration tasks on individual instances. This can be safely done by giving an individual instance administrator login rights to just that instance. But, for security reasons, the appliance administrator might not want to allow the instance to be on the same network as the Management Service. This is a very common scenario in service provider environments, and it is becoming increasingly common in enterprises as they adopt virtualization and cloud architectures.

In the following example, the Management Service is in the 10.1.1.x network and the Citrix ADC instances are in the 10.1.2.x network. Interfaces 0/1 and 0/2 are the management interfaces, 1/1 to 1/8 are 1G data interfaces, and 10/1 to 10/4 are 10G data interfaces. Each instance has its own dedicated administrator and its own dedicated physical interface. Therefore, the number of instances is limited to the number of physical interfaces available on the appliance. VLAN filtering is not required, because each instance has its own dedicated interface. Optionally, disable VLAN filtering to configure up to 4096 VLANs per instance per interface. In this example, you do not need to configure an NSVLAN, because instances are not sharing a physical interface and there are no tagged VLANs. For more information about NSVLANs, see the **Add a Citrix ADC instance** section in [Provisioning Citrix ADC instances](#).

The following figure illustrates the above use case.

Figure 1. Network topology of an SDX appliance with Management Service and NSIPs for Instances in different networks

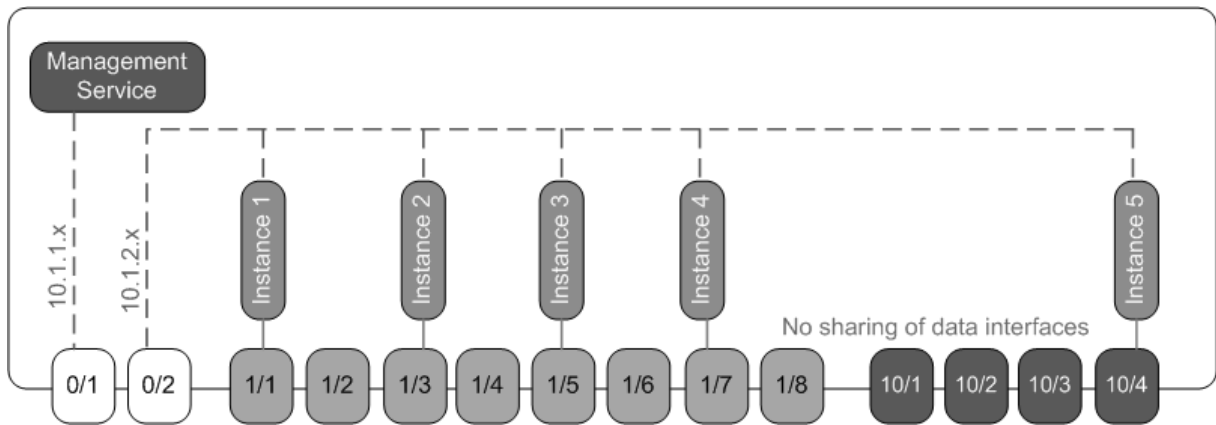

As the appliance administrator, you have the option to keep the traffic between the Management Service and the NSIP addresses on the SDX appliance, or to force the traffic off the device if, for example, you want traffic to go through an external firewall or some other security intermediary and then return to the appliance.

The following table lists the names and values of the parameters used for provisioning Citrix ADC instance 1 in this example.

Parameter Name	Values for Instance 1
Name	vpx1
IP Address	10.1.2.2
Netmask	255.255.255.0
Gateway	10.1.2.1
XVA File	NS-VPX-XEN-10.0-51.308.a_nc.xva
Feature License	Platinum
Admin Profile	ns_nsroot_profile
User Name	vpx1
Password	Sdx
Confirm Password	Sdx
Shell/Sftp/Scp Access	True
Total Memory (MB)	2048
#SSL Chips	1
Throughput (Mbps)	1000
Packets per second	1000000

Parameter Name	Values for Instance 1
CPU	Shared
Interface	0/2 and 1/1

To provision Citrix ADC instance 1 as shown in this example

1. On the Configuration tab, in the navigation pane, expand Citrix ADC Configuration, and then click Instances.
2. In the Citrix ADC instances pane, click Add.
3. In the Provision Citrix ADC Wizard follow the instructions in the wizard to set the parameters to the values shown in the above table.
4. Click Create, and then click Close. The Citrix ADC instance you provisioned appears in the Citrix ADC instances pane.

Consolidation Across Security Zones

September 27, 2025

An SDX appliance is often used for consolidation across security zones. The DMZ adds an extra layer of security to an organization's internal network, because an attacker has access only to the DMZ, not to the internal network of the organization. In high-compliance environments, a single Citrix® ADC instance with VIP addresses in both the DMZ and an internal network is generally not acceptable. With SDX, you can provision instances hosting VIP addresses in the DMZ, and other instances hosting VIP addresses in an internal network.

In some cases, you might need separate management networks for each security zone. In such cases, you have to put the NSIP addresses of the instances in the DMZ on one network, and put the NSIP addresses of the instances with VIPs in the internal network on a different management network. Also, in many cases, communication between the Management Service and the instances might need to be routed through an external device, such as a router. You can configure firewall policies to control the traffic that is sent to the firewall and to log the traffic.

The SDX appliance has two management interfaces (0/1 and 0/2) and, depending on the model, up to eight 1G data ports and eight 10G data ports. You can also use the data ports as management ports (for example, when you need to configure tagged VLANs, because tagging is not allowed on the management interfaces). If you do so, the traffic from the Management Service must leave the appliance and then return to the appliance. You can route this traffic or, optionally, specify an NSVLAN

on an interface assigned to the instance. If the instances are configured on a management interface that is common with the Management Service, the traffic between the Management Service and Citrix ADC instances does not have to be routed, unless your setup explicitly requires it.

Note Tagging is supported in Citrix Hypervisor version 6.0.

Consolidation with Dedicated Interfaces for Each Instance

September 27, 2025

In the following example, the instances are part of multiple networks. Interface 0/1 is assigned to the Management Service, which is part of the internal 10.1.1.x network. Citrix ADC instances 2 and 3 are part of the 10.1.200.x network (VLAN 100), and Citrix ADC instances 4 and 5 are part of the 10.1.3.x network (VLAN 200).

Optionally, you can configure an NSVLAN on all of the instances.

The following figure illustrates the above use case.

Figure 1. Network topology of an SDX appliance with Citrix® ADC instances in multiple networks

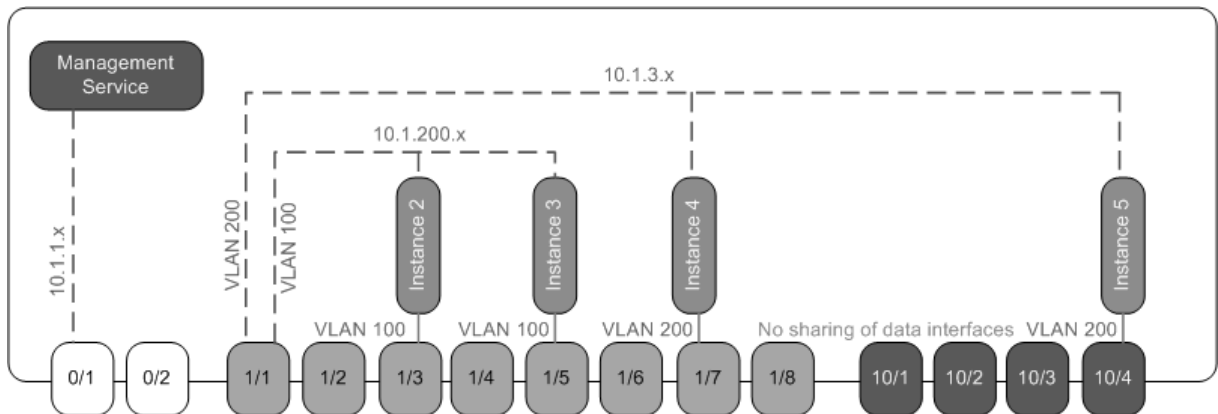

The SDX appliance is connected to a switch. Make sure that VLAN IDs 100 and 200 are configured on the switch port to which port 1/1 on the appliance is connected.

The following table lists the names and values of the parameters used for provisioning Citrix ADC instances 5 and 3 in this example.

Parameter Name	Values for Instance 5	Values for Instance 3
Name	vp5	vp3
IP Address	10.1.3.2	10.1.200.2
Netmask	255.255.255.0	255.255.255.240

Parameter Name	Values for Instance 5	Values for Instance 3
Gateway	10.1.3.1	10.1.200.1
XVA File	NS-VPX-XEN-10.0-51.308.a_nc.xva	NS-VPX-XEN-10.0-51.308.a_nc.xva
Feature License	Platinum	Platinum
Admin Profile	ns_nsroot_profile	ns_nsroot_profile
User Name	vpx5	vpx3
Password	Sdx	root
Confirm Password	Sdx	root
Shell/Sftp/Scp Access	True	True
Total Memory (MB)	2048	2048
#SSL Chips	1	1
Throughput (Mbps)	1000	1000
Packets per second	1000000	1000000
CPU	Shared	Shared
Interface	1/1 and 10/4	1/1 and 1/5
NSVLAN	200	100
Add (interface)	1/1	1/1
Tagged Interface	Select Tagged	Select Tagged

To provision Citrix ADC instances 5 and 3 as shown in this example

1. On the Configuration tab, in the navigation pane, expand Citrix ADC Configuration, and then click Instances.
2. In the Citrix ADC instances pane, click Add.
3. In the Provision Citrix ADC Wizard follow the instructions in the wizard to set the parameters to the values shown in the above table.
4. Click Create, and then click Close. The Citrix ADC instance you provisioned appears in the Citrix ADC instances pane.

Consolidation With Sharing of a Physical Port by More Than One Instance

September 27, 2025

You can enable and disable VLAN filtering on an interface as required. For example, if you need to configure more than 100 VLANs on an instance, assign a dedicated physical interface to that instance and disable VLAN filtering on that interface. Enable VLAN filtering on instances that share a physical interface, so that traffic for one instance is not seen by the other instance.

Note

VLAN filtering is not a global setting on the appliance. You enable or disable VLAN filtering on an interface, and the setting applies to all instances associated with that interface. If VLAN filtering is disabled, you can configure up to 4096 VLANs. If VLAN filtering is enabled, you can configure up to 63 tagged VLANs on a 10G interface and up to 32 tagged VLANs on a 1G interface.

In the following example, the instances are part of multiple networks.

- Interface 1/1 is assigned as a management interface to all the instances. Interface 0/1 is assigned to the Management Service, which is part of the internal 10.1.1.x network.
- Citrix ADC instances 2 and 3 are in the 10.1.200.x network, and instances 4, 5, 6, and 7 are in the 10.1.3.x network. Instances 2 and 3 each have a dedicated physical interface. Instances 4 and 7 share physical interface 1/7, and instances 5 and 6 share physical interface 10/4.
- VLAN filtering is enabled on interface 1/7. Traffic for Instance 4 is tagged for VLAN 4, and traffic for Instance 7 is tagged for VLAN 7. As a result, traffic for Instance 4 is not visible to Instance 7, and vice versa. A maximum of 32 VLANs can be configured on interface 1/7.
- VLAN filtering is disabled on interface 10/4, so you can configure up to 4096 VLANs on that interface. Configure VLANs 500-599 on Instance 5 and VLANs 600-699 on Instance 6. Instance 5 can see the broadcast and multicast traffic from VLAN 600-699, but the packets are dropped at the software level. Similarly, Instance 6 can see the broadcast and multicast traffic from VLAN 500-599, but the packets are dropped at the software level.

The following figure illustrates the above use case.

Figure 1. Network topology of an SDX appliance with Management Service and Citrix® ADC instances distributed across networks

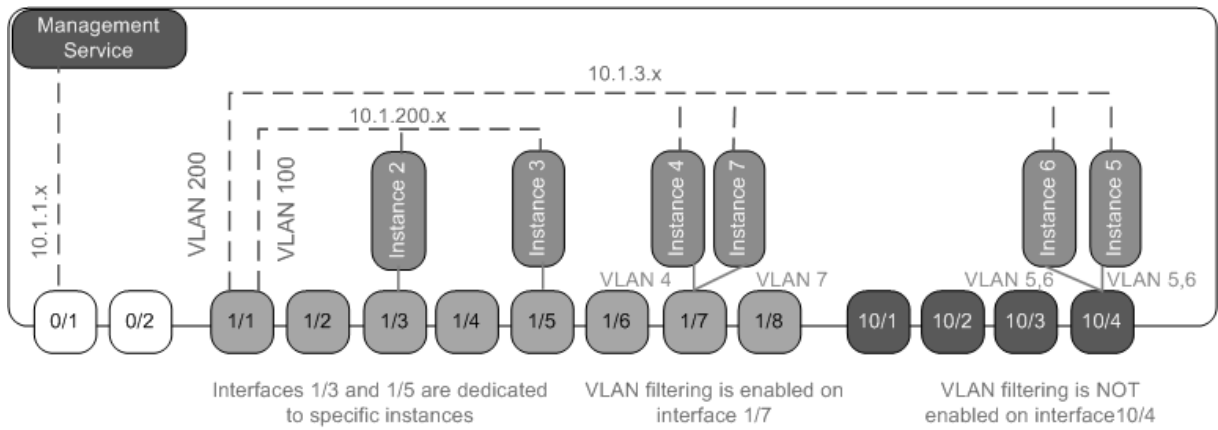

The following table lists the names and values of the parameters used for provisioning Citrix ADC instances 7 and 4 in this example.

Parameter Name	Values for Instance 7	Values for Instance 4
Name	vpx7	vpx4
IP Address	10.1.3.7	10.1.3.4
Netmask	255.255.255.0	255.255.255.240
Gateway	10.1.3.1	10.1.3.1
XVA File	NS-VPX-XEN-10.0-51.308.a_nc.xva	NS-VPX-XEN-10.0-51.308.a_nc.xva
Feature License	Platinum	Platinum
Admin Profile	ns_nsroot_profile	ns_nsroot_profile
User Name	vpx4	vpx4
Password	Sdx	Sdx
Confirm Password	Sdx	Sdx
Shell/Sftp/Scp Access	True	True
Total Memory (MB)	2048	2048
#SSL Chips	1	1
Throughput (Mbps)	1000	1000
Packets per second	1000000	1000000
CPU	Shared	Shared
Interface	1/1 and 1/7	1/1 and 1/7
NSVLAN	200	200

To provision Citrix ADC instances 7 and 4 in this example

1. On the Configuration tab, in the navigation pane, expand Citrix ADC Configuration, and then click Instances.
2. In the Citrix ADC instances pane, click Add.
3. In the Provision Citrix ADC Wizard follow the instructions in the wizard to set the parameters to the values shown in the above table.
4. Click Create, and then click Close. The Citrix ADC instance you provisioned appears in the Citrix ADC instances pane.

NITRO API

September 27, 2025

The NetScaler SDX NITRO protocol allows you to configure and monitor the SDX appliance programmatically.

NITRO exposes its functionality through Representational State Transfer (REST) interfaces. Therefore, NITRO applications can be developed in any programming language. Additionally, for applications that must be developed in Java or .NET or Python, the NITRO protocol is exposed as relevant libraries that are packaged as separate Software Development Kits (SDKs).

Note: You must have a basic understanding of the SDX appliance before using NITRO.

To use the NITRO protocol, the client application needs the following:

- Access to a SDX appliance.
- To use REST interfaces, you must have a system to generate HTTP or HTTPS requests (payload in JSON format) to the SDX appliance. You can use any programming language or tool.
- For Java clients, you must have a system where Java Development Kit (JDK) 1.5 or above version is available. The JDK can be downloaded from <http://www.oracle.com/technetwork/java/javase/downloads/index.html>.
- For .NET clients, you must have a system where .NET framework 3.5 or above version is available. The .NET framework can be downloaded from <http://www.microsoft.com/downloads/en/default.aspx>.
- For Python clients, you must have a system where Python 2.7 or above version and the Requests library (available in <NITRO_SDK_HOME>/lib) is installed.

Obtaining the NITRO Package

September 27, 2025

The NITRO package is available as a tar file on the Downloads page of the SDX appliance's configuration utility. You must download and un-tar the file to a folder on your local system. This folder is referred to as `<NITRO_SDK_HOME>` in this documentation.

The folder contains the NITRO libraries in the `lib` subfolder. The libraries must be added to the client application classpath to access NITRO functionality. The `<NITRO_SDK_HOME>` folder also provides samples and documentation that can help you understand the NITRO SDK.

Note:

- The REST package contains only documentation for using the REST interfaces.
- For the Python SDK, the library must be installed on the client path. For installation instructions, read the `\<NITRO_SDK_HOME\>/README.txt` file.

.NET SDK

September 27, 2025

SDX NITRO APIs are categorized depending on the scope and purpose of the APIs into system APIs and configuration APIs. You can also troubleshoot NITRO operations.

System APIs

The first step towards using NITRO is to establish a session with the SDX appliance and then authenticate the session by using the administrator's credentials.

You must create an object of the `nitro_service` class by specifying the IP address of the appliance and the protocol to connect to the appliance (HTTP or HTTPS). You then use this object and log on to the appliance by specifying the user name and the password of the administrator.

Note: You must have a user account on that appliance. The configuration operations that you can perform are limited by the administrative role assigned to your account.

The following sample code connects to a SDX appliance with IP address 10.102.31.16 by using HTTPS protocol:

```
`` pre codeblock
//Specify the IP address of the appliance and service type
nitro_service nitroservice = new nitro_service ("10.102.31.16", "https");

//Specify the login credentials
nitroservice.login("nsroot", "verysecret");
```

```
1 Note: You must use the
2 nitro\_service object in all further NITRO operations on the appliance.
3
4 To disconnect from the appliance, invoke the logout() method as follows
5   :
6   `` pre codeblock
7   nitroservice.logout();
```

Configuration APIs

The NITRO protocol can be used to configure resources of the SDX appliance.

The APIs to configure a resource are grouped into packages or namespaces that have the format `com.citrix.sdx.nitro.resource.config.<resource_type>`. Each of these packages or namespaces contain a class named `<resource_type>` that provides the APIs to configure the resource.

For example, the NetScaler resource has the `com.citrix.sdx.nitro.resource.config.ns` package or namespace.

A resource class provides APIs to perform other operations such as creating a resource, retrieving resources and resource properties, updating a resource, deleting resources, and performing bulk operations on resources.

Creating a Resource

To create a new resource (for example, a Citrix® ADC instance) on the SDX appliance:

1. Set the value for the required properties of the resource by using the corresponding property name. The result is a resource object that contains the details required for the resource.
Note: These values are set locally on the client. The values are not reflected on the appliance till the object is uploaded.
2. Upload the resource object to the appliance, using the static `add()` method.

The following sample code creates a Citrix ADC instance named "ns_instance" on the SDX appliance:

```
`` pre codeblock
ns newns = new ns();
```

```
//Set the properties of the NetScaler locally
newns.name = "ns_instance";
newns.ip_address = "10.70.136.5";
newns.netmask = "255.255.255.0";
newns.gateway = "10.70.136.1";
newns.image_name = "nsvpx-9.3.45_nc.xva";
newns.profile_name = "ns_nsroot_profile";
newns.vm_memory_total = 2048;
newns.throughput = 1000;
newns.pps = 1000000;
newns.license = "Standard";
newns.username = "admin";
newns.password = "admin";

int number_of_interfaces = 2;
network_interface[] interface_array = new network_interface[number_of_interfaces];

//Adding 10/1
interface_array[0] = new network_interface();
interface_array[0].port_name = "10/1";

//Adding 10/2
interface_array[1] = new network_interface();
interface_array[1].port_name = "10/2";

newns.network_interfaces = interface_array;

//Upload the Citrix ADC instance
ns result = ns.add(nitroservice, newns);
```

```
1  ### Retrieve Resource Details
2
3  To retrieve the properties of a resource on the SDX appliance, do the
   following:
4
5  1. Retrieve the configurations from the appliance by using the get()
   method. The result is a resource object.
6  2. Extract the required property from the object by using the
   corresponding property name.
7
8  The following sample code retrieves the details of all NetScaler®
   resources:
9
10  ``` pre codeblock
11  //Retrieve the resource object from the SDX appliance
12  ns[] returned_ns = ns.get(nitroservice);
13
14  //Extract the properties of the resource from the object
```

```

15 Console.WriteLine(returned_ns[i].ip_address);
16 Console.WriteLine(returned_ns[i].netmask);

```

Retrieve Resource Statistics

A SDX appliance collects statistics on the usage of its features. You can retrieve these statistics using NITRO.

The following sample code retrieves statistics of a Citrix ADC instance with ID 123456a:

```

```

ns obj = new ns();
obj.id = "123456a";
ns stats = ns.get(nitroservice, obj);
Console.WriteLine("CPU Usage:" + stats.ns_cpu_usage);
Console.WriteLine("Memory Usage:" + stats.ns_memory_usage);
Console.WriteLine("Request rate/sec:" + stats.http_req);

```

```

```

1  ### Updating a Resource
2
3  To update the properties of an existing resource on the appliance, do
   the following:
4
5  1. Set the id property to the ID of the resource to be updated.
6  2. Set the value for the required properties of the resource by using
   the corresponding property name. The result is a resource object.
7     Note: These values are set locally on the client. The values are
   not reflected on the appliance till the object is uploaded.
8  3. Upload the resource object to the appliance, using the update()
   method.
9
10 The following sample code updates the name of the Citrix ADC instance
   with ID 123456a to 'ns\_instance\_new':
11
12 ``` pre codeblock
13 ns update_obj = new ns();
14
15 //Set the ID of the NetScaler to be updated
16 update_obj.id = "123456a";
17
18 //Get existing NetScaler details
19 update_obj = ns.get(nitroservice, update_obj);
20
21 //Update the name of the NetScaler to "ns_instance_new" locally
22 update_obj.name = "ns_instance_new";
23
24 //Upload the updated NetScaler details
25 ns result = ns.update(nitroservice, update_obj);

```

Deleting a Resource

To delete an existing resource, invoke the static method `delete()` on the resource class, by passing the ID of the resource to be removed, as an argument.

The following sample code deletes a Citrix ADC instance with ID 1:

```
“ pre codeblock
ns obj = new ns();
obj.id = “123456a”;
ns.delete(nitroservice, obj);
```

```
1  ### Bulk Operations
2
3  You can query or change multiple resources simultaneously and thus
   minimize network traffic. For example, you can add multiple
   NetScaler SDX appliances in the same operation.
4
5  Each resource class has methods that take an array of resources for
   adding, updating, and removing resources. To perform a bulk
   operation, specify the details of each operation locally and then
   send the details at one time to the server.
6
7  To account for the failure of some operations within the bulk operation
   , NITRO allows you to configure one of the following behaviors:
8
9  - **Exit.** When the first error is encountered, the execution stops.
   The commands that were executed before the error are committed.
10 - **Continue.** All the commands in the list are executed even if some
   commands fail.
11
12 Note: You must configure the required behavior while establishing a
   connection with the appliance, by setting the
13 onerror param in the
14 nitro\_service() method.
15
16 The following sample code adds two NetScalers in one operation:
17
18 `` pre codeblock
19 ns[] newns = new ns[2];
20
21 //Specify details of first NetScaler
22 newns[0] = new ns();
23 newns[0].name = "ns_instance1";
24 newns[0].ip_address = "10.70.136.5";
25 newns[0].netmask = "255.255.255.0";
26 newns[0].gateway = "10.70.136.1";
27 ...
28 ...
29
30 //Specify details of second NetScaler
31 newns[1] = new ns();
```

```
32 newns[1].name = "ns_instance2";
33 newns[1].ip_address = "10.70.136.8";
34 newns[1].netmask = "255.255.255.0";
35 newns[1].gateway = "10.70.136.1";
36 ...
37 ...
38
39 //upload the details of the NetScalers to the NITRO server
40 ns[] result = ns.add(nitroservice, newns);
```

Exception Handling

The errorcode field indicates the status of the operation.

- An errorcode of 0 indicates that the operation is successful.
- A non-zero errorcode indicates an error in processing the NITRO request.

The error message field provides a brief explanation and the nature of the failure.

All exceptions in the execution of NITRO APIs are caught by the `com.citrix.sdx.nitro.exception.nitro_exception` class. To get information about the exception, you can use the `getErrorCode()` method.

For a more detailed description of the error codes, see the API reference available in the `<NITRO_SDK_HOME>/doc` folder.

REST Web Services

September 27, 2025

REST (Representational State Transfer) is an architectural style based on simple HTTP requests and responses between the client and the server. REST is used to query or change the state of objects on the server side. In REST, the server side is modeled as a set of entities where each entity is identified by a unique URL.

Each resource also has a state on which the following operations can be performed:

- **Create.** Clients can create new server-side resources on a “container” resource. You can think of container resources as folders, and child resources as files or subfolders. The calling client provides the state for the resource to be created. The state can be specified in the request by using XML or JSON format. The client can also specify the unique URL that will identify the new object. Alternatively, the server can choose and return a unique URL identifying the created object. The HTTP method used for create requests is POST.

- **Read.** Clients can retrieve the state of a resource by specifying its URL with the HTTP GET method. The response message contains the resource state, expressed in JSON format.
- **Update.** You can update the state of an existing resource by specifying the URL that identifies that object and its new state in JSON or XML, using the PUT HTTP method.
- **Delete.** You can destroy a resource that exists on the server-side by using the DELETE HTTP method and the URL identifying the resource to be removed.

In addition to these four CRUD operations (Create, Read, Update, and Delete), resources can support other operations or actions. These operations use the HTTP POST method, with the request body in JSON specifying the operation to be performed and parameters for that operation.

SDX NITRO APIs are categorized depending on the scope and purpose of the APIs into system APIs and configuration APIs.

System APIs

The first step towards using NITRO is to establish a session with the SDX appliance and then authenticate the session by using the administrator's credentials.

You must specify the username and password in the login object. The session ID that is created must be specified in the request header of all further operations in the session.

Note: You must have a user account on that appliance. The configurations that you can perform are limited by the administrative role assigned to your account.

To connect to a SDX appliance with IP address 10.102.31.16 by using the HTTPS protocol:

- **URL** `https://10.102.31.16/nitro/v2/config/login/`
- **HTTP Method** POST
- **Request**

- **Header**

```
pre codeblock Content-Type:application/vnd.com.citrix.sdx.  
login+json
```

Note: Content types such as 'application/x-www-form-urlencoded' that were supported in earlier versions of NITRO can also be used. You must make sure that the payload is the same as used in earlier versions. The payloads provided in this documentation are only applicable if the content type is of the form 'application/vnd.com.citrix.sdx.login+json'.

- **Payload**

```
pre codeblock { "login": { "username":"nsroot", "password":"  
verysecret"} }
```

- **Response Payload**

- **Header**

```
pre codeblock HTTP/1.0 201 Created Set-Cookie: NITRO_AUTH_TOKEN=##87305E9C51B06C848F0942; path=/nitro/v2
```

Note: You must use the session ID in all further NITRO operations on the appliance.

Note: By default, the connection to the appliance expires after 30 minutes of inactivity. You can modify the timeout period by specifying a new timeout period (in seconds) in the login object. For example, to modify the timeout period to 60 minutes, the request payload is:

```
pre codeblock { "login": { "username":"nsroot", "password":"verysecret", "timeout":3600 } }
```

You can also connect to the appliance to perform a single operation, by specifying the username and password in the request header of the operation. For example, to connect to an appliance while creating a Citrix® ADC instance:

- **URL**

- **HTTP Method**

- **Request**

- **Header**

```
pre codeblock X-NITRO-USER:nsroot X-NITRO-PASS:verysecret Content-Type:application/vnd.com.citrix.sdx.ns+json
```

- **Payload**

```
pre codeblock { "ns": { ... } }
```

- **Response.**

- **Header**

```
pre codeblock HTTP/1.0 201 Created
```

To disconnect from the appliance, use the DELETE method:

- **URL**

- **HTTP Method** DELETE

- **Request**

- **Header**

```
pre codeblock Cookie:NITRO_AUTH_TOKEN=tokenvalue Content-Type:application/vnd.com.citrix.sdx.login+json
```

Configuration APIs

The NITRO protocol can be used to configure resources of the SDX appliance.

Each SDX resource has a unique URL associated with it, depending on the type of operation to be performed. URLs for configuration operations have the format: `http://<IP>/nitro/v2/config/<resource_type>`

Creating a Resource

To create a new resource (for example, a Citrix ADC instance) on the SDX appliance, specify the resource name and other related arguments in the specific resource object. For example, to create a Citrix ADC instance named `vp1`:

- **URL**
- **HTTP Method**
- **Request**

- **Header**

```
pre codeblock Cookie:NITRO_AUTH_TOKEN=tokenvalue Content-Type:application/vnd.com.citrix.sdx.ns+json
```

- **Payload**

```
pre codeblock { "ns": { "name":"vp1", "ip_address":"192.168.100.2", "netmask":"255.255.255.0", "gateway":"192.168.100.1", "image_name":"nsvpx-9.3-45_nc.xva", "vm_memory_total":2048, "throughput":1000, "pps":1000000, "license":"Standard", "profile_name":"ns_nsroot_profile", "username":"admin", "password":"admin", "network_interfaces": [ { "port_name":"10/1" } , { "port_name":"10/2" } ] } }
```

Retrieving Resource Details and Statistics

SDX resource details can be retrieved as follows:

- To retrieve details of a specific resource on the SDX appliance, specify the id of the resource in the URL.
- To retrieve the properties of resources on the basis of some filter, specify the filter conditions in the URL.

The URL has the form: `http://<IP>/nitro/v2/config/<resource_type>?filter=<property1>:<value>,<property2>:<value>`

- If your request is likely to result in a large number of resources returned from the appliance, you can retrieve these results in chunks by dividing them into “pages” and retrieving them page by page.

For example, assume that you want to retrieve all Citrix ADC instances on a SDX that has 53 of them. Instead of retrieving all 53 in one big response, you can configure the results to be divided into pages of 10 Citrix ADC instances each (6 pages total), and retrieve them from the server page by page.

You specify the page count with the `pagesize` query string parameter and use the `pageno` query string parameter to specify the page number that you want to retrieve.

The URL has the form: `http://<IP>/nitro/v2/config/<resource_type>?pageno=<value>&pagesize=<value>`

You do not have to retrieve all the pages, or retrieve the pages in order. Each request is independent, and you can even change the `pagesize` setting between requests.

Note: If you want to have an idea of the number of resources that are likely to be returned by a request, you can use the `count` query string parameter to ask for a count of the resources to be returned, rather than the resources themselves. To get the number of Citrix ADC instances available, the URL would be

`http://<IP>/nitro/v2/config/<resource_type>?count=yes`

To retrieve the configuration information for the Citrix ADC instance with ID 123456a:

- **URL**
- **HTTP Method** GET

Updating a Resource

To update an existing SDX resource, use the PUT HTTP method. In the HTTP request payload, specify the name and the other arguments that have to be changed. For example, to change the name of Citrix ADC instance with ID 123456a to `vpx2`:

- **URL**
- **HTTP Method**
- **Request Payload**
 - **Header**

```
pre codeblock Cookie:NITRO_AUTH_TOKEN=tokenvalue Content-Type:application/vnd.com.citrix.sdx.ns+json
```
 - **Payload**

```
pre codeblock { "ns": { "name":"vpx2", "id":"123456a" } }
```

Deleting a Resource

To delete an existing resource, specify the name of the resource to be deleted in the URL. For example, to delete a Citrix ADC instance with ID 123456a:

- **URL**
- **HTTP Method**
- **Request**
 - **Header**

```
pre codeblock Cookie:NITRO_AUTH_TOKEN=tokenvalue Content-Type:application/vnd.com.citrix.sdx.ns+json
```

Bulk Operations

You can query or change multiple resources simultaneously and thus minimize network traffic. For example, you can add multiple NetScaler SDX appliances in the same operation. You can also add resources of different types in one request.

To account for the failure of some operations within the bulk operation, NITRO allows you to configure one of the following behaviors:

- **Exit.** When the first error is encountered, the execution stops. The commands that were executed before the error are committed.
- **Continue.** All the commands in the list are executed even if some commands fail.

Note: You must configure the required behavior in the request header using the X-NITRO-ONERROR parameter.

To add 2 Citrix ADC resources in one operation and continue if one command fails:

- **URL.**
- **HTTP Method.**
- **Request Payload.**
 - **Header**

```
pre codeblock Cookie:NITRO_AUTH_TOKEN=tokenvalue Content-Type:application/vnd.com.citrix.sdx.ns+json X-NITRO-ONERROR:continue
```

- **Payload**

```
pre codeblock { "ns": [ { "name":"ns_instance1", "ip_address":"10.70.136.5", "netmask":"255.255.255.0", "gateway":"10.70.136.1" } , { "name":"ns_instance2", "ip_address":"10.70.136.8", "netmask":"255.255.255.0", "gateway":"10.70.136.1" } ] }
```

To add multiple resources (Citrix ADC and two MPS users) in one operation and continue if one command fails:

- **URL.**
- **HTTP Method.** POST
- **Request Payload.**

- **Header**

```
pre codeblock Cookie:NITRO_AUTH_TOKEN=tokenvalue Content-Type:application/vnd.com.citrix.sdx.ns+json X-NITRO-ONERROR:continue
```

- **Payload**

```
pre codeblock { "ns": [ { "name":"ns_instance1", "ip_address":"10.70.136.5", "netmask":"255.255.255.0", "gateway":"10.70.136.1" } , { "name":"ns_instance2", "ip_address":"10.70.136.8", "netmask":"255.255.255.0", "gateway":"10.70.136.1" } ], "mpsuser": [ { "name":"admin", "password":"admin", "permission":"superuser" } , { "name":"admin", "password":"admin", "permission":"superuser" } ] }
```

Exception Handling

The errorcode field indicates the status of the operation.

- An errorcode of 0 indicates that the operation is successful.
- A non-zero errorcode indicates an error in processing the NITRO request.

The error message field provides a brief explanation and the nature of the failure.

How NITRO Works

September 27, 2025

The NITRO infrastructure consists of a client application and the NITRO Web service running on a NetScaler SDX appliance. The communication between the client application and the NITRO web service is based on REST architecture using HTTP or HTTPS.

Figure 1. NITRO execution flow

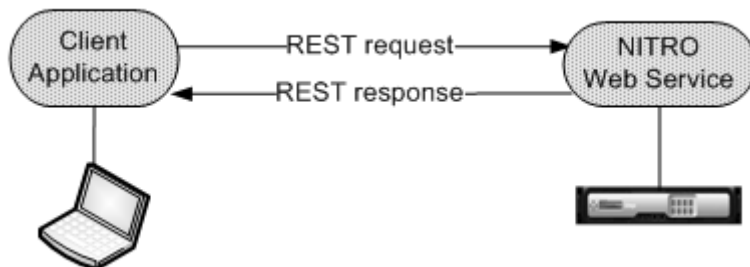

As shown in the above figure, a NITRO request is executed as follows:

1. The client application sends REST request message to the NITRO web service. When using the SDKs, an API call is translated into the appropriate REST request message.
2. The web service processes the REST request message.
3. The NITRO web service returns the corresponding REST response message to the client application. When using the SDKs, the REST response message is translated into the appropriate response for the API call.

To minimize traffic on the network, you retrieve the whole state of a resource from the server, make modifications to the state of the resource locally, and then upload it back to the server in one network transaction.

Note: Local operations on a resource (changing its properties) do not affect its state on the server until the state of the object is explicitly uploaded.

NITRO APIs are synchronous in nature. This means that the client application waits for a response from the NITRO web service before executing another NITRO API.

Java SDK

September 27, 2025

SDX NITRO APIs are categorized depending on the scope and purpose of the APIs into system APIs and configuration APIs. You can also troubleshoot NITRO operations.

System APIs

The first step towards using NITRO is to establish a session with the SDX appliance and then authenticate the session by using the administrator's credentials.

You must create an object of the `nitro_service` class by specifying the IP address of the appliance and the protocol to connect to the appliance (HTTP or HTTPS). You then use this object and log on to the appliance by specifying the user name and the password of the administrator.

Note: You must have a user account on that appliance. The configuration operations that you can perform are limited by the administrative role assigned to your account.

The following sample code connects to a SDX appliance with IP address 10.102.31.16 by using HTTPS protocol:

```
“ pre codeblock
//Specify the IP address of the appliance and service type
nitro_service nitroservice = new nitro_service (“10.102.31.16”, “https”);

//Specify the login credentials
nitroservice.login(“nsroot”, “verysecret”);
```

```
1 Note: You must use the
2 nitro\_service object in all further NITRO operations on the appliance.
3
4 To disconnect from the appliance, invoke the logout() method as follows
5   :
6   `` pre codeblock
7   nitroservice.logout();
```

Configuration APIs

The NITRO protocol can be used to configure resources of the SDX appliance.

The APIs to configure a resource are grouped into packages or namespaces that have the format `com.citrix.sdx.nitro.resource.config.<resource_type>`. Each of these packages or namespaces contain a class named `<resource_type>` that provides the APIs to configure the resource.

For example, the NetScaler resource has the `com.citrix.sdx.nitro.resource.config.ns` package or namespace.

A resource class provides APIs to perform other operations such as creating a resource, retrieving resource details and statistics, updating a resource, deleting resources, and performing bulk operations on resources.

Creating a Resource

To create a new resource (for example, a Citrix® ADC instance) on the SDX appliance, do the following:

1. Set the value for the required properties of the resource by using the corresponding property name. The result is a resource object that contains the details required for the resource.
Note: These values are set locally on the client. The values are not reflected on the appliance till the object is uploaded.
2. Upload the resource object to the appliance, using the static add() method.

The following sample code creates a Citrix ADC instance named “ns_instance” on the SDX appliance:

```
“ pre codeblock
ns newns = new ns();

//Set the properties of the NetScaler locally
newns.set_name(“ns_instance”);
newns.set_ip_address(“10.70.136.5”);
newns.set_netmask(“255.255.255.0”);
newns.set_gateway(“10.70.136.1”);
newns.set_image_name(“nsvpx-9.3.45_nc.xva”);
newns.set_profile_name(“ns_nsroot_profile”);
newns.set_vm_memory_total(new Double(2048));
newns.set_throughput(new Double(1000));
newns.set_pps(new Double(1000000));
newns.set_license(“Standard”);
newns.set_username(“admin”);
newns.set_password(“admin”);

int number_of_interfaces = 2;
network_interface[] interface_array = new network_interface[number_of_interfaces];

//Adding 10/1
interface_array[0] = new network_interface();
interface_array[0].set_port_name(“10/1”);

//Adding 10/2
interface_array[1] = new network_interface();
interface_array[1].set_port_name(“10/2”);

newns.set_network_interfaces(interface_array);

//Upload the Citrix ADC instance
ns result = ns.add(nitroservice, newns);
```

```
1  ### Retrieving Resource Details
2
3  To retrieve the properties of a resource on the SDX appliance, do the
   following:
4
```

```

5 1. Retrieve the configurations from the appliance by using the get()
   method. The result is a resource object.
6 2. Extract the required property from the object by using the
   corresponding property name.
7
8 The following sample code retrieves the details of all NetScaler®
   resources:
9
10 ``` pre codeblock
11 //Retrieve the resource object from the SDX appliance
12 ns[] returned_ns = ns.get(nitroservice);
13
14 //Extract the properties of the resource from the object
15 System.out.println(returned_ns[i].get_ip_address());
16 System.out.println(returned_ns[i].get_netmask());

```

Retrieving Resource Statistics

A SDX appliance collects statistics on the usage of its features. You can retrieve these statistics using NITRO.

The following sample code retrieves statistics of a Citrix ADC instance with ID 123456a:

```

``` pre codeblock
ns obj = new ns();
obj.set_id("123456a");
ns stats = ns.get(nitroservice, obj);
System.out.println("CPU Usage:" + stats.get_ns_cpu_usage());
System.out.println("Memory Usage:" + stats.get_ns_memory_usage());
System.out.println("Request rate/sec:" + stats.get_http_req());

```

```

1 ### Updating a Resource
2
3 To update the properties of an existing resource on the appliance, do
 the following:
4
5 1. Set the id property to the ID of the resource to be updated.
6 2. Set the value for the required properties of the resource by using
 the corresponding property name. The result is a resource object.
7 Note: These values are set locally on the client. The values are
 not reflected on the appliance till the object is uploaded.
8 3. Upload the resource object to the appliance, using the update()
 method.
9
10 The following sample code updates the name of the Citrix ADC instance
 with ID 123456a to 'ns_instance_new':
11
12 ``` pre codeblock
13 ns update_obj = new ns();

```

```

14
15 //Set the ID of the NetScaler to be updated
16 update_obj.set_id("123456a");
17
18 //Get existing NetScaler details
19 update_obj = ns.get(nitroservice, update_obj);
20
21 //Update the name of the NetScaler to "ns_instance_new" locally
22 update_obj.set_name("ns_instance_new");
23
24 //Upload the updated NetScaler details
25 ns result = ns.update(nitroservice, update_obj);

```

## Deleting a Resource

To delete an existing resource, invoke the static method `delete()` on the resource class, by passing the ID of the resource to be removed, as an argument.

The following sample code deletes a Citrix ADC instance with ID 1:

```

““ pre codeblock
ns obj= new ns();
obj.set_id("123456a");
ns.delete(nitroservice, obj);

```

```

1 ### Bulk Operations
2
3 You can query or change multiple resources simultaneously and thus
 minimize network traffic. For example, you can add multiple
 NetScaler SDX appliances in the same operation.
4
5 Each resource class has methods that take an array of resources for
 adding, updating, and removing resources. To perform a bulk
 operation, specify the details of each operation locally and then
 send the details at one time to the server.
6
7 To account for the failure of some operations within the bulk operation
 , NITRO allows you to configure one of the following behaviors:
8
9 - **Exit.** When the first error is encountered, the execution stops.
 The commands that were executed before the error are committed.
10 - **Continue.** All the commands in the list are executed even if some
 commands fail.
11
12 Note: You must configure the required behavior while establishing a
 connection with the appliance, by setting the
13 onerror param in the
14 nitro_service() method.
15
16 The following sample code adds two NetScalers in one operation:

```

```

17
18 ``` pre codeblock
19 ns[] newns = new ns[2];
20
21 //Specify details of first NetScaler
22 newns[0] = new ns();
23 newns[0].set_name("ns_instance1");
24 newns[0].set_ip_address("10.70.136.5");
25 newns[0].set_netmask("255.255.255.0");
26 newns[0].set_gateway("10.70.136.1");
27 ...
28 ...
29 ...
30
31 //Specify details of second NetScaler
32 newns[1] = new ns();
33 newns[1].set_name("ns_instance2");
34 newns[1].set_ip_address("10.70.136.8");
35 newns[1].set_netmask("255.255.255.0");
36 newns[1].set_gateway("10.70.136.1");
37 ...
38 ...
39
40 //upload the details of the NetScalers to the NITRO server
41 ns[] result = ns.add(nitroservice, newns);

```

## Exception Handling

The errorcode field indicates the status of the operation.

- An errorcode of 0 indicates that the operation is successful.
- A non-zero errorcode indicates an error in processing the NITRO request.

The error message field provides a brief explanation and the nature of the failure.

All exceptions in the execution of NITRO APIs are caught by the `com.citrix.sdx.nitro.exception.nitro_exception` class. To get information about the exception, you can use the `getErrorCode()` method.

For a more detailed description of the error codes, see the API reference available in the <NITRO\_SDK\_HOME>/doc folder.



© 2025 Cloud Software Group, Inc. All rights reserved. This document is subject to U.S. and international copyright laws and treaties. No part of this document may be reproduced in any form without the written authorization of Cloud Software Group, Inc. This and other products of Cloud Software Group may be covered by registered patents. For details, please refer to the Virtual Patent Marking document located at <https://www.cloud.com/legal>. Citrix, the Citrix logo, NetScaler, and the NetScaler logo and other marks appearing herein are either registered trademarks or trademarks of Cloud Software Group, Inc. and/or its subsidiaries in the United States and/or other countries. Other marks are the property of their respective owner(s) and are mentioned for identification purposes only. Please refer to Cloud SG's Trademark Guidelines and Third Party Trademark Notices (<https://www.cloud.com/legal>) for more information.