



# NetScaler SDX 13.1

## Contents

<b>Introduction</b>	<b>4</b>
<b>Release Notes</b>	<b>4</b>
<b>Get started with the Management Service user interface</b>	<b>5</b>
<b>Data governance</b>	<b>10</b>
<b>Introduction to NetScaler Console service connect for NetScaler SDX appliances</b>	<b>13</b>
<b>Single bundle upgrade</b>	<b>16</b>
<b>Upgrading a NetScaler instance</b>	<b>18</b>
<b>Manage and monitor the SDX appliance</b>	<b>21</b>
<b>SDX administrative domains</b>	<b>27</b>
<b>Managing RAID disk allocation on the SDX 22000 platform</b>	<b>29</b>
<b>SDX Licensing Overview</b>	<b>33</b>
<b>SDX resource visualizer</b>	<b>36</b>
<b>Manage interfaces</b>	<b>37</b>
<b>Jumbo Frames on SDX Appliances</b>	<b>40</b>
<b>Configuring SNMP on SDX Appliances</b>	<b>54</b>
<b>Configure syslog notifications</b>	<b>60</b>
<b>Configuring Mail Notifications</b>	<b>61</b>
<b>Configure SMS notifications</b>	<b>62</b>
<b>Monitor and manage the real-time status of entities configured on an SDX appliance</b>	<b>63</b>
<b>Monitoring and Managing Events Generated on NetScaler instances</b>	<b>68</b>
<b>Call Home support for NetScaler instances on an SDX appliance</b>	<b>75</b>
<b>System health monitoring</b>	<b>77</b>
<b>Configuring System Notification Settings</b>	<b>80</b>

<b>Enable and disable features from the Management Service</b>	<b>81</b>
<b>Configure the Management Service</b>	<b>81</b>
<b>Configure authentication and authorization settings</b>	<b>85</b>
<b>Configuring the external authentication server</b>	<b>90</b>
<b>Configure link aggregation from the Management Service</b>	<b>96</b>
<b>Configuring a channel from the Management Service</b>	<b>97</b>
<b>Access control lists</b>	<b>99</b>
<b>Set up a cluster of NetScaler instances</b>	<b>105</b>
<b>Configuring cluster link aggregation</b>	<b>109</b>
<b>Configure SSL ciphers to securely access the Management Service</b>	<b>113</b>
<b>Back up and restore the configuration data of the SDX appliance</b>	<b>121</b>
<b>Perform an appliance reset</b>	<b>125</b>
<b>Cascading external authentication servers</b>	<b>129</b>
<b>Unlock a user</b>	<b>130</b>
<b>Provision NetScaler instances</b>	<b>131</b>
<b>Manage crypto capacity</b>	<b>146</b>
<b>Provision third-party virtual machines</b>	<b>152</b>
<b>SECUREMATRIX GSB</b>	<b>153</b>
<b>Trend Micro InterScan Web Security</b>	<b>157</b>
<b>Websense Protector</b>	<b>159</b>
<b>BlueCat DNS/DHCP</b>	<b>163</b>
<b>CA Access Gateway</b>	<b>166</b>
<b>Palo Alto Networks VM-Series</b>	<b>168</b>
<b>Deploy a Citrix SD-WAN VPX instance on a NetScaler SDX appliance</b>	<b>171</b>

<b>Bandwidth Metering in SDX</b>	<b>175</b>
<b>Configure and manage NetScaler instances</b>	<b>179</b>
<b>Install and manage SSL certificates</b>	<b>182</b>
<b>Allow L2 mode on a NetScaler instance</b>	<b>186</b>
<b>Configuring a Virtual MAC on an interface</b>	<b>187</b>
<b>Generate partition MAC addresses to configure an admin partition on a NetScaler instance in the SDX appliance</b>	<b>189</b>
<b>Change management for VPX instances</b>	<b>191</b>
<b>Monitor NetScaler instances</b>	<b>193</b>
<b>Use logs to monitor operations and events</b>	<b>196</b>
<b>Use cases for NetScaler SDX appliances</b>	<b>199</b>
<b>Consolidation when the Management Service and the NetScaler instances are in the same network</b>	<b>199</b>
<b>Consolidation when the Management Service and the NetScaler instances are in different networks</b>	<b>201</b>
<b>Consolidation across security zones</b>	<b>203</b>
<b>Consolidation with dedicated interfaces for each instance</b>	<b>204</b>
<b>Consolidation with sharing of a physical port by more than one instance</b>	<b>206</b>
<b>NITRO API</b>	<b>208</b>
<b>Obtaining the NITRO Package</b>	<b>209</b>
<b>.NET SDK</b>	<b>209</b>
<b>REST web services</b>	<b>214</b>
<b>How NITRO Works</b>	<b>223</b>
<b>Java SDK</b>	<b>224</b>

## Introduction

August 1, 2023

The NetScaler SDX appliance is a multitenant platform on which you can provision and manage multiple NetScaler virtual machines (instances). The SDX appliance addresses cloud computing and multitenancy requirements by allowing a single administrator to configure and manage the appliance and delegate the administration of each hosted instance to tenants. The SDX appliance enables the appliance administrator to provide each tenant the following benefits:

- One complete instance. Each instance has the following privileges:
  - Dedicated CPU and memory resources
  - A separate space for entities
  - The independence to run the release and build of their choice
  - Lifecycle independence
- A completely isolated network. Traffic meant for a particular instance is sent only to that instance.

The SDX appliance provides a Management Service that is preprovisioned on the appliance. The Management Service provides a user interface (HTTP and HTTPS modes) and an API to configure, manage, and monitor the appliance, the Management Service, and the instances. A Citrix self-signed certificate is prepackaged for HTTPS support. Citrix recommends that you use the HTTPS mode to access the Management Service user interface.

## Release Notes

August 1, 2023

Release notes describe the enhancements, changes, bug fixes, and known issues for a particular release or build of the NetScaler software. The NetScaler SDX release notes are covered as a part of the ADC release notes.

For detailed information about SDX 13.1 enhancements, known issues, and bug fixes, see [ADC release notes](#).

## Get started with the Management Service user interface

October 20, 2023

To begin configuring, managing, and monitoring the appliance, the Management Service, and the virtual instances, connect to the Management Service user interface by using a browser. Then provision the virtual instances on the appliance.

You can connect to the Management Service user interface by using one of the following supported browsers:

- Internet Explorer
- Google Chrome
- Apple Safari
- Mozilla Firefox

### Log on to the Management Service user interface

1. In your Web browser address field, type one of the following:

`http://Management Service IP Address`

or

`https://Management Service IP Address`

2. In the Login page, in **User Name** and **Password**, type the user name and password of the Management Service. The default user name is `nsroot`. If the default password does not work, try typing the serial number of the appliance. The serial number bar code is available at the back of the appliance. After you log in with the default credentials for the first time, you must change your default `nsroot` password. For information about changing the admin password, see [Changing the Password of the Default User Account](#).
3. Click Show Options, and then do the following:
  - a) In the **Start in** list, select the page that must be displayed immediately after you log on to the user interface. The available options are Home, Monitoring, Configuration, Documentation, and Downloads. For example, if you want the Management Service to display the Configuration page when you log on, select **Configuration** in the **Start in** list.
  - b) In **Timeout**, type the length of time (in minutes, hours, or days) after which you want the session to expire. The minimum timeout value is 15 minutes.

The **Start in** and **Timeout** settings persist across sessions. Their default values are restored only after you clear the cache.

4. Click **Login** to log on to the Management Service user interface.

## Initial setup wizard

You can use the Setup Wizard to complete all the first time configurations in a single flow.

You can use the wizard to configure network configuration details and system settings, change the default administrative password, and manage and update licenses.

You can also use this wizard to modify the network configuration details that you specified for the SDX appliance during initial configuration.

To access the wizard, navigate to **Configuration > System** and, under **Set Up Appliance**, click **Setup Wizard**. Enter values for the following parameters.

- **Interface:** Management interface that connects the appliance to a management workstation or network. Possible values: 0/1, 0/2. Default: 0/1.
- **Gateway:** IP address of the router that forwards traffic out of the appliance's subnet.
- Select the IPv4 check box if you want to use the IPv4 address for the Management Service and enter the details for the following parameters:
  - **Appliance Management IP:** The IPv4 address that is used to access the Management Service by using a Web browser.
  - **Netmask:** The subnet mask in which the SDX appliance is located.
- **DNS:** IPv4 address of the primary DNS server. IPv6 addresses are not supported for the primary DNS server.
- Select the IPv6 check box if you want to use the IPv6 address for the Management Service and enter the details for the following parameters:
  - **Management Service IP Address:** The IPv6 address that is used to access the Management Service by using a Web browser.
  - **Gateway IPv6 Address:** The IPv4 address of the router that forwards traffic out of the appliance's subnet.
- Select **Additional DNS** to add DNS server IP addresses as an extra DNS server apart from the primary DNS server. The IP addresses can be either IPv4 or IPv6.

← Network Configuration

**Management Service**

Interface\*  
0/1

Gateway\*  
10 . 102 . 103 . 1

IPv4

Appliance Management IP\*  
10 . 102 . 103 . 239

Netmask\*  
255 . 255 . 255 . 0

DNS  
10 . 140 . 50 . 5

IPv6  
 Additional DNS

**Appliance Supportability**

Configure Appliance supportability

OK Close

### Important!

Citrix recommends that you keep Appliance Supportability disabled for improved security. To disable appliance supportability, navigate to **System > Network Configuration** and clear the **Configure Appliance supportability** check box.

Under **System Settings**, you can specify that the Management Service and a NetScaler instance must communicate with each other only over a secure channel. You can also restrict access to the Management Service user interface. Clients can log on the Management Service user interface only by using https.

You can modify the time zone of the Management Service and the Citrix Hypervisor. The default time zone is UTC. You can change the Administrative password by selecting the **Change Password** check box and typing the new password.

Under Manage Licenses you can manage and allocate licenses. You can use your hardware serial number (HSN) or your license access code to allocate your licenses. Alternatively, if a license is already present on your local computer, you can upload it to the appliance.

Select the licenses on the appliance and click **Done** to complete the initial configuration.

### Provision instances on an SDX appliance

You can provision one or more NetScaler or third-party instances on the SDX appliance by using the Management Service. The number of instances that you can install depends on the license you have purchased. If the number of instances added is equal to the number specified in the license, the Management Service does not allow provisioning more instances.



For information about provisioning third-party instances, see [Third-Party Virtual Machines](#).

## Console access

You can access the console of NetScaler instances, the Management Service, Citrix Hypervisor, and third party VMs from the Management Service interface. This access is helpful in debugging and troubleshooting the instances hosted on the SDX appliance.

To access the console of VMs, navigate to the instance listing, select the VM from the list, and in the **Action** list, click **Console Access**.

To access the console of Management Service or Citrix Hypervisor, navigate to **Configuration > System**, and under **Console Access**, click **Management Service** or **Citrix Hypervisor** link.

Note: Internet Explorer browser does not support console access. Citrix recommends using the console access feature through Management Service HTTPS sessions only.

## Management Service statistics

The dashboard now includes Management Service Statistics for monitoring the use of memory, CPU, and disk resources by the Management Service on the SDX appliance.

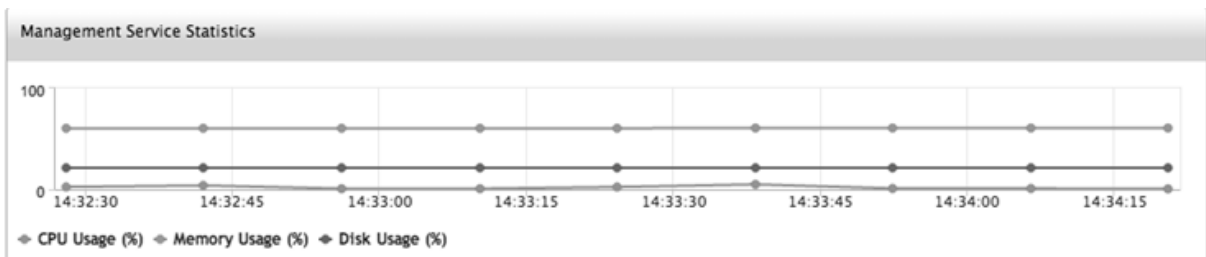

## Single sign-on to the Management Service and the NetScaler instances

After logging on to the Management Service by using your user credentials, you do not have to provide the user credentials again for logging on to an instance. By default, the **Timeout** value is set to 30 minutes and the configuration tab is opened in a new browser window.

## Manage the Home page

The Management Service Home page provides you with a high-level view of the performance of the SDX appliance and the instances provisioned on your appliance. The information about the SDX appliance and instance is displayed in gadgets that you can add and remove depending on your requirement.

The following gadgets are available on the Home page by default.

- **System Resources:** Displays the total number of CPU cores, total number of SSL chips, number of free SSL chips, total memory, and free memory on the appliance.

---

**System CPU	Memory Usage (%):** Displays the percentage of CPU and memory utilization of the appliance in graphical format.
--------------	---

---

- 
- **System WAN/LAN Throughput (Mbps):** Displays the total throughput of the SDX appliance for incoming and outgoing traffic in a graph that is plotted in real time and updated at regular intervals.
- **NetScaler instances:** Displays the properties of the NetScaler instances. The properties displayed are Name, VM State, Instance State, IP Address, Rx (Mbps), Tx (Mbps), HTTP Req/s, and CPU Usage (%) and Memory Usage (%).  
Note: On the first logon, the Home page does not display any data related to the NetScaler instances because you have not provisioned any instances on your appliance.
- **Health Monitoring Events:** Displays the last 25 events, with their severity, message, and the date and time that the event occurred.

You can do the following on the Home page:

- View and hide NetScaler instance details

You can view and hide the details of a particular NetScaler instance by clicking the name of the instance in the Name column.

You can also click Expand All to expand all the instance nodes and Collapse All to collapse all the instance nodes.

- Add and remove gadgets

You can also add gadgets to view other system information.

To add these gadgets, click the arrow («) button at the top right corner of the Home page, enter keywords in the search box, and then click Go. The allowed characters are: a-z, A-Z, 0–9, ^, \$, \*, and \_. Click Go without typing any characters in the search box to display all the gadgets that are available. After the gadget is displayed, click Add to dashboard.

Currently, you can add the following gadgets to the Home page:

- **Hypervisor Details:** The Hypervisor Details gadget displays details about Citrix Hypervisor uptime, edition, version, iSCSI Qualified Name (IQN), product code, serial number, build date, and build number.

- **Licenses:** The Licenses gadget displays the following details: the SDX hardware platform, the maximum number of instances supported on the platform, the maximum supported throughput in Mbps, and the available throughput in Mbps.

If you remove a gadget that is available on the Home page by default, you can add them back to the Home page by searching for the gadget.

## Ports

The following ports must be open on the SDX appliance for it to function properly.

---

Type	Port	Details
TCP	80	Used for incoming HTTP (GUI and NITRO) requests. One of the primary interfaces to access the SDX Management Service interface.
TCP	443	Used for incoming secured HTTP (GUI and NITRO) requests. One of the primary interfaces to access the SDX Management Service interface.
TCP	22	Used for SSH and SCP access to the SDX Management Service interface.
UDP	162	The SDX Management Service interface listens for SNMP traps from the NetScaler instances hosted on the SDX appliance.
UDP	161	The SDX Management Service interface listens for SNMP walks/get requests.

---

## Data governance

August 1, 2023

## What is a NetScaler Console service connect?

NetScaler Application Delivery Management (ADM) Service Connect is a feature to enable seamless onboarding of NetScaler SDX appliances onto NetScaler Console service. This feature lets the NetScaler SDX appliance automatically securely connect with the NetScaler Console service and send system, usage and telemetry data to it. Based on this data, you get insights and recommendations for your NetScaler infrastructure on NetScaler Console service.

By using the NetScaler Console service connect feature and onboarding your NetScaler SDX appliances to NetScaler Console service, you can manage all your NetScaler and NetScaler Gateway assets whether on-premises or in the cloud. In addition, you benefit from access to a rich set of visibility features that help in quick identification of performance issues, high resource usage, critical errors, and so on. NetScaler Console service provides a wide range of capabilities for your NetScaler instances and applications. For more information on NetScaler Console service, see [NetScaler Application Delivery Management Service](#).

### Important

- This document pertains to NetScaler SDX appliances. For more information on NetScaler appliance, see [Introduction to NetScaler Console service connect for NetScaler appliances](#).
- NetScaler Gateway also supports the NetScaler Console service connect feature. For better ease, the NetScaler Gateway appliance is not called explicitly in the consecutive sections.

### Note:

NetScaler Console service connect feature has been released for NetScaler instances, and NetScaler Gateway instances. However, the corresponding functionality on the NetScaler Console service is available in the upcoming release. The value of this feature will be unleashed soon with the NetScaler Console service release. Citrix will update this note when it happens.

The benefits of this new capability can be used once released on NetScaler Console service.

## What is NetScaler Console service?

NetScaler Console service is a cloud-based solution that helps you manage, monitor, orchestrate, automate, and troubleshoot your NetScaler SDX instances by providing you analytical insights and curated machine learning based recommendations about NetScaler SDX instances and about application health, performance, and security. For more information, see [NetScaler Console service Overview](#).

## How the NetScaler Console service connect is enabled?

NetScaler Console service connect is enabled by default, after you install or upgrade NetScaler SDX to release 13.1.

## What data is captured using NetScaler Console service connect?

The following details are captured using NetScaler Console service connect:

- **NetScaler SDX details**
  - Management IP address
  - Platform description
  - Platform type
  - Host name
  - System ID
  - Encoded serial ID
  - Version
  - Serial ID
  - Host ID
  - Type
  - Build type
- **Key usage metrics**
  - Management CPU percentage
  - Memory usage percentage
  - CPU usage percentage
  - System uptime
  - System date time

## How the data is used?

By collecting the data, NetScaler can provide timely and in-depth insights about your NetScaler SDX installations, which include the following:

- **Key metrics.** Details of key metrics pertaining to CPU, memory, throughput, SSL throughput, and highlight anomalous behavior on NetScaler SDX instances.
- **Critical errors.** Any critical errors that might have occurred on your NetScaler instances.
- **Deployment advisory.** Identify NetScaler instances that are deployed in standalone mode but have high throughput and are vulnerable to a single point of failure.

### **How long the collected data is retained?**

Any Data collected is retained for no longer than 13 months.

If you decide to terminate the use of the service by disabling the NetScaler Console service connect feature from the NetScaler, any previously collected data is deleted after a period of 30 days.

### **Where the data is stored and how secure is it?**

All data collected by NetScaler Console service connect is stored in one of the three regions—United States, European Union, and Australia and New Zealand (ANZ). For more information, see [Geographical Considerations](#).

The data is stored securely with strict tenant isolation at the database layer.

### **How to disable NetScaler Console service connect?**

If you want to disable data collection through NetScaler Console service connect, see [How to enable and disable NetScaler Console service connect](#).

## **Introduction to NetScaler Console service connect for NetScaler SDX appliances**

March 7, 2024

NetScaler Console service is a cloud-based solution that helps you manage, monitor, orchestrate, automate, and troubleshoot your NetScaler SDX appliances. It also provides analytical insights and curated machine learning based recommendations for your applications health, performance, and security. For more information, see [NetScaler Console service](#).

NetScaler Application Delivery Management (ADM) service connect is a feature to enable seamless onboarding of NetScaler SDX appliances onto NetScaler Console service. This feature helps NetScaler SDX appliances and NetScaler Console service to function as a holistic solution, which offers customers multi fold benefits.

NetScaler Console service connect feature lets the NetScaler SDX instance automatically connect with NetScaler Console service and send system, usage, and telemetry data to it. Using this data, the NetScaler Console service gives you some insights and recommendations on your NetScaler SDX infrastructure - like quick identification of performance issues, and high resource usage.

To harness the power of NetScaler Console service, you can choose to onboard your NetScaler SDX appliances to NetScaler Console service. The onboarding process uses ADM service connect, and makes the experience seamless and faster for you.

#### Points to note

- NetScaler Console service connect is now available on NetScaler MPX, SDX, and VPX instances, and NetScaler Gateway appliances.
- NetScaler Console service connect is not yet available on the NetScaler Console service.

For more information, see [Data governance](#).

### **How does NetScaler Console service connect support with NetScaler Console service?**

Here is a high-level workflow of how the NetScaler Console service connect feature on NetScaler interacts with NetScaler Console service.

1. NetScaler Console service connect feature on NetScaler SDX appliance auto connects with NetScaler Console service using a periodic probe request.
2. This request has system, usage and telemetry data, using which the NetScaler Console service gives you some insights and recommendations on your NetScaler infrastructure - like quick identification of performance issues, and high resource usage.
3. You can view the insights and recommendations and decide to onboard your NetScaler SDX appliances to the NetScaler Console service to start managing your NetScaler SDX appliances.
4. When you decide to onboard, the NetScaler Console service connect feature helps complete the onboarding seamlessly.

### **What versions of NetScaler is NetScaler Console service connect supported on?**

NetScaler Console service connect is supported on all NetScaler platforms and all appliance models (MPX, VPX, and SDX). Starting from NetScaler release 13.0 build 64.xx, NetScaler Console service connect is enabled by default for NetScaler SDX appliances.

### **How to enable NetScaler Console service connect?**

If you are an existing NetScaler customer, and upgrade to NetScaler release 13.0 build 64.xx, NetScaler Console service connect is enabled by default as part of the upgrade process.

If you are a new NetScaler customer, installing NetScaler release 13.0 build 64.xx, NetScaler Console service connect is enabled by default as part of the install process.

### Note

Unlike the new NetScaler appliances, existing NetScaler SDX appliances find the route through Citrix Insight Service (CIS) or Call Home.

## How to enable and disable NetScaler Console service connect?

You can enable and disable NetScaler Console service connect from CLI, GUI, or NITRO API methods.

### Using the CLI

To enable the NetScaler Console service connect by using the CLI

At the command prompt, type:

```
1 set autoreg_setting autoreg=true
```

To disable the NetScaler Console service connect by using the CLI

At the command prompt, type:

```
1 set autoreg_setting autoreg=false
```

To display NetScaler Console service connect settings by using the CLI

```
1 show autoreg_setting
2
3         autoreg: true
4
5     is_banner_displayed: true
6
7 Done
```

### Using the GUI

To disable the NetScaler Console service connect by using the NetScaler GUI

1. Navigate to **System**. On the **System** page, click **Configure NetScaler Console service connect** under **System Settings** section.
2. On the **Configure ADM Parameters** page, clear **Enable NetScaler Console service connect**, and click **OK**.





### Using the NITRO API

You can disable NetScaler Console service connect by using the NITRO command.

```
curl -X PUT -H "Content-Type:application/json" http://192.0.2.10/nitro/v1/config/sdx_autoreg -d '{ "sdx_autoreg":{ "autoreg":"false" } } ' -u nsroot:Test@1
```

### NetScaler Console built-in agent behavior

From NetScaler release 13.0 build 61.xx and higher, NetScaler SDX instances have built in agent with ADM service connect functionality. The NetScaler Console built-in agent available on NetScaler SDX instances starts like an active daemon and communicates with ADM service. After communication with ADM service is established, the built-in agent auto-upgrades itself to the latest software version regularly.

### References

For more information on NetScaler Console service connect, see the following topics:

- Data governance: [Data governance](#).
- NetScaler Console service: [NetScaler Application Delivery Management Service](#).

### Single bundle upgrade

October 9, 2023

**Note:** The NetScaler Console service connect is enabled by default, after you install or upgrade the NetScaler SDX appliance to release 13.1. For more details, see [Data governance](#) and [NetScaler Console service connect](#).

The single bundle upgrade, available from 11.0 and later releases, combines all the components except the NetScaler VPX instance image and LOM firmware in a single image file. This file is called the SDX image.

### Note

From release 12.0 build 57.19, lights out management (LOM) firmware is added to the SBI, and Citrix customers don't have to upgrade the LOM separately. The LOM firmware is not written by Citrix.

Using this image, you can upgrade all the components in a single step, eliminating the chances of incompatibility between various components. A single bundle upgrade also ensures that your appliance is always running a version that Citrix has tested and supports. Because all the SDX components are combined in a single file, the SDX image file is larger than the Management Service image file.

The file name of the image is of the format `build-sdx-13.1-<build_number>.tgz`. After the Management Service is upgraded to SDX 13.1 the new GUI does not display the options to upload the Citrix Hypervisor image file, supplemental packs, or hotfixes. The options are missing because SDX 13.1 does not support upgrading individual components.

### Points to note

- The single bundle upgrade is a multi-step process that might take up to 90 mins.
- First, the Management Service is upgraded to the newer, provided version. During the upgrade, connectivity to the Management Service might be lost. Reconnect to the Management Service to monitor the status of the upgrade.
- Next, the new Management Service upgrades the Citrix Hypervisor and completes the remainder of the appliance upgrade. Management Service from release 11.0 and later can perform the full Citrix Hypervisor upgrade.
- Do not restart the appliance during the Citrix Hypervisor upgrade.
- Citrix recommends that you use a Citrix Hypervisor serial console (or LOM console) to monitor the Citrix Hypervisor upgrade.

### Upgrade the entire appliance to 13.1

**Note:** The upgrade process reboots the entire SDX appliance, including all VPX instances, multiple times. Before performing this procedure, if the VPX instances are in an HA setup, fail over all primary HA nodes to the secondary node. If you do not have an HA deployment, plan for the downtime accordingly.

#### To upgrade the appliance:

1. Upload the single bundle image file, navigate to **Configuration > Management Service > Software Images**, and then click **Upload**.
2. Navigate to **Configuration > System > System Administration**.
3. In the System Administration group, click **Upgrade Appliance**.  
The upgrade process takes a few minutes.

Before the upgrade, the Management Service displays the following information:

- Single bundle image file name.
- The current version of SDX running on your appliance.
- The selected version to which the appliance is to be upgraded.
- Approximate time to upgrade the appliance.
- Miscellaneous information.

Before clicking **Upgrade Appliance**, make sure that you have reviewed all the information displayed on the screen. You cannot abort the upgrade process once it starts.

### Supported upgrade paths

	11.1	12.0	12.1	13.0	13.1	14.1
10.5 or 11.0	Y	Y	Y	N*	N*	N*
11.1–65.x and later	NA	Not recommended	12.1-56.x and later	Y	Y	Y
12.1	NA	NA	Not recommended	Y	Y	Y

\*From 10.5, 11.0, and 11.1 older builds, you must first upgrade to release 11.1 or 12.1, and then upgrade to release 13.0, 13.1, or 14.1.

### Related information

[NetScaler SDX hardware-software compatibility matrix](#)

[Demystifying the NetScaler SDX appliance upgrade process](#)

## Upgrading a NetScaler instance

August 1, 2023

### Notes

- The NetScaler Console service connect is enabled by default, after you install or upgrade the NetScaler SDX appliance to release 13.1. For more details, see [Data governance](#) and [NetScaler Console service connect](#).
- The NetScaler SDX appliance upgrade process requires a single reboot instead of two reboots from version 13.1 build 37.x onwards.

The process of upgrading the NetScaler instances involves uploading the build file, and then upgrading the NetScaler instance.

### Important

Downgrading an ADC instance using the Management Service is not supported. Use the instance CLI to downgrade.

Upload the NetScaler software images to the NetScaler SDX appliance before upgrading the NetScaler instances. For installing a new instance, you need the NetScaler XVA file.

In the **Software Images** pane, you can view the following details.

- **Name:** Name of the NetScaler instance software image file. The file name contains the release number and build number. For example, the file name build-10-53.5\_nc.tgz refers to release 10 build 53.5.
- **Last Modified:** Date when the file was last modified.
- **Size:** Size, in MB, of the file.

### To upload a software image

1. In the navigation pane, expand NetScaler, and then click **Software Images**.
2. In the **Software Images** pane, click **Upload**.
3. In the **Upload NetScaler Software Image** dialog box, click **Browse** and select the NetScaler image file that you want to upload.
4. Click **Upload**. The image file appears in the NetScaler Software Images pane.

### To create a backup by downloading a build file

1. In the Software Images pane, select the file you want to download, and then click **Download**.
2. In the message box, from the **Save** list, select **Save as**.
3. In the Save As message box, browse to the location where you want to save the file, and then click **Save**.

### To upload an XVA file

1. In the navigation pane, expand NetScaler, and then click **Software Images**.
2. In the Software Images pane, on the **XVA Files** tab, click **Upload**.
3. In the **Upload NetScaler XVA File** dialog box, click **Browse** and select the NetScaler XVA file you want to upload.
4. Click **Upload**. The XVA file appears in the **XVA Files** pane.

### To create a backup by downloading an XVA file

1. In the XVA Files pane, select the file you want to download, and then click **Download**.
2. In the message box, from the Save list, select **Save as**.
3. In the **Save As** message box, browse to the location where you want to save the file, and then click **Save**.

### Upgrade NetScaler VPX instances

You can use the Management Service to upgrade one or more of the VPX instances running on the appliance. Before upgrading an instance, make sure that you have uploaded the correct build to the SDX appliance.

Before you start upgrading any instance, ensure that you understand the licensing framework and types of licenses. A software edition upgrade (such as from a standard edition to the enterprise edition or from an enterprise edition to the platinum edition) might require new licenses. Also note the following:

- To prevent any loss of configuration, save the configuration on each instance before you upgrade any instances.
- You can also upgrade an individual instance from the Instances node. To do so, select the instance from the Instances node. In the details pane, select the instance, and then in the Actions drop down menu, click Upgrade.

#### Important

If you use the SDX Management Service and not the VPX GUI to upgrade VPX instances, the upgrade images are part of the backup file and allow you to restore the instance smoothly.

### To upgrade VPX instances

1. On the **Configuration** tab, in the navigation pane, click **NetScaler**.
2. In the details pane, under **NetScaler Configuration**, click **Upgrade**.

3. In the **Upgrade NetScaler** dialog box, in **Software Image**, select the NetScaler upgrade build file of the version to which you want to upgrade.
4. From the **Instance IP Address** drop-down list, select the IP addresses of the instances that you want to upgrade.
5. Click **OK**, and then click Close.

### Related information

[NetScaler SDX hardware-software compatibility matrix](#)

[Demystifying the NetScaler SDX appliance upgrade process](#)

## Manage and monitor the SDX appliance

December 12, 2023

After your NetScaler SDX appliance is up and running, you can perform various tasks to manage and monitor the appliance from the Management Service user interface.

### Modify the network configuration of the SDX appliance

You can modify the network configuration details that you provided for the SDX appliance during initial configuration.

To modify the network configuration of the SDX appliance, click **System**. In the **System** pane, under the **Setup Appliance** group, click **Network Configuration** and enter the details in the wizard.

**Note:** On **Network Configuration**, when you enable access to the Citrix Hypervisor, a warning message “Access will be disabled automatically after six hours” is displayed.

### Change the password of the default user account

The default user account provides complete access to all features of the NetScaler SDX appliance. To preserve security, use the default admin account only when necessary. Only individuals whose duties require full access must know the password for the default admin account. Citrix recommends changing the default admin password frequently. If you lose the password, you can reset the password to the default by reverting the appliance settings to factory defaults, and you can then change the password.

To change the password of the default user account, click **System > User Administration > Users**. Select a user and click **Edit** to change the password.

### **Modify the time zone on the appliance**

You can modify the time zone of the Management Service and the Citrix Hypervisor. The default time zone is UTC.

To modify the time zone, click **System** and in the **System Settings** group, click **Change Time Zone**.

### **Modify the host name of the appliance**

You can change the host name of the Management Service by navigating to **System > System Settings > Change Hostname**.

The Citrix Hypervisor host name will be backed up and restored during the backup/restore operation. During configuration reset, the Citrix Hypervisor host name will be reset to the default value “netscaler-sdx”.

### **VLAN filtering**

VLAN filtering provides segregation of data between VPX instances that share a physical port. For example, if you have configured two VPX instances on two different VLANs and you enable VLAN filtering, one instance cannot view the other instance’s traffic. If VLAN filtering is disabled, all the instances can see the tagged or untagged broadcast packets, but the packets are dropped at the software level. If VLAN filtering is enabled, each tagged broadcast packet reaches only the instance that belongs to the corresponding tagged VLAN. If none of the instances belong to the corresponding tagged VLAN, the packet is dropped at the hardware level (NIC).

If VLAN filtering is enabled on an interface, a limited number of tagged VLANs can be used on that interface. 63 tagged VLANs on a 10G interface and 32 tagged VLANs on a 1G interface. A VPX instance receives only the packets that have the configured VLAN IDs. Restart the VPX instances associated with an interface if you change the state of the VLAN filter from DISABLED to ENABLED on that interface.

VLAN filtering is enabled by default on the SDX appliance. If you disable VLAN filtering on an interface, you can configure up to 4096 VLANs on that interface.

**Note:** VLAN filtering can be disabled only on an SDX appliance running Citrix Hypervisor version 6.0.

To enable VLAN filtering on an interface, click **System > Interfaces**. Select an interface and click **VLAN Filter** and enter the details to enable VLAN filtering.

### **Configure clock synchronization**

When you enable Network Time Protocol (NTP) sync, the Management Service is restarted. You can configure your SDX appliance to synchronize its local clock with an NTP server. As a result, the clock

on the SDX appliance has the same date and time settings as the other servers on your network. The clock synchronization configuration does not change if the appliance is restarted, upgraded, or downgraded. However, the configuration does not get propagated to the secondary NetScaler instance in a high availability setup.

The clock is synchronized immediately if you add an NTP server or change any of the authentication parameters. You can also explicitly enable and disable NTP synchronization.

Note: If you do not have a local NTP server, you can find a list of public, open access, NTP servers at the official NTP site,

<http://www.ntp.org>. Before configuring your NetScaler to use a public NTP server, be sure to read the Rules of Engagement page (link included on all Public Time Servers pages).

To configure an NTP server, click **System > NTP Servers**.

### To enable NTP synchronization

1. In the navigation pane, expand **System**, and then click **NTP Servers**.
2. In the details pane, click **NTP Synchronization**.
3. In the **NTP Synchronization** dialog box, select **Enable NTP Sync**.
4. Click **OK**, and then click **Close**.

### To modify authentication options

1. In the navigation pane, expand **System**, and then click **NTP Servers**.
2. In the details pane, click **Authentication Parameters**.
3. In the **Modify Authentication Options** dialog box, set the following parameters:
  - **Authentication**—Enable NTP authentication. Possible values: YES, NO. Default: YES.
  - **Trusted Key IDs**—The trusted key IDs. While adding an NTP server, you select a key identifier from this list. Minimum value: 1. Maximum value: 65534.
  - **Revoke Interval**—The interval between rerandomization of certain cryptographic values used by the Autokey scheme, as a power of 2, in seconds. Default value: 17 ( $2^{17}=36$  hours).
  - **Automax Interval**—The interval between regeneration of the session key list used with the Autokey protocol, as a power of 2, in seconds. Default value: 12 ( $2^{12}=1.1$  hours).
4. Click **OK**, and then click **Close**.

### View the properties of the SDX appliance

View system properties such as the number of CPU cores and SSL chips, total available memory and free memory, and various product details on the **Configuration** tab.



To view the properties of the SDX appliance, click the **Configuration** tab.

You can view the following information about system resources, Hypervisor, License, and System:

**System Resources:**

- **Total CPU Cores:** The number of CPU cores on the SDX appliance.
- **Total SSL Chips:** The total number of SSL chips on the SDX appliance.
- **Free SSL chips:** The total number of SSL chips that have not been assigned to an instance.
- **Total Memory (GB):** Total appliance memory in GB.
- **Free Memory (GB):** Free appliance memory in GB.

**Hypervisor Information:**

- **Uptime:** Time since the appliance was last restarted, in number of days, hours, and minutes.
- **Edition:** The edition of the Citrix Hypervisor that is installed on the SDX appliance.
- **Version:** The version of the Citrix Hypervisor that is installed on the SDX appliance.
- **iSCSI IQN:** The iSCSI Qualified Name.
- **Product Code:** Product code of Citrix Hypervisor.
- **Serial Number:** Serial number of Citrix Hypervisor.
- **Build Date:** Build date of Citrix Hypervisor.
- **Build Number:** Build number of Citrix Hypervisor.
- **Supplemental Pack:** Version of the supplemental pack installed on the SDX appliance.

**License Information:**

- **Platform:** Model number of the hardware platform, based on the installed license.
- **Maximum Instances:** The maximum number of instances that you can set up on the SDX appliance, based on the installed license.
- **Available Instances (Shared):** The number of instances that can be configured depending on the number of CPU cores that are still available.
- **Maximum Throughput (Mbps):** The maximum throughput that can be achieved on the appliance, based on the installed license.
- **Available Throughput (Mbps):** The available throughput based on the installed license.

**System Information:**

- **Platform:** Model number of the hardware platform.

- **Product:** Type of NetScaler product.
- **Build:** NetScaler release and build running on the SDX appliance.
- **IP Address:** IP address of the Management Service.
- **Host ID:** Citrix Hypervisor host ID.
- **System ID:** Citrix Hypervisor system ID.
- **Serial Number:** Citrix Hypervisor serial number.
- **System Time:** System time displayed in Day Month Date Hours:Min:Sec Timezone Year format.
- **Uptime:** Time since the Management Service was last restarted, in the number of days, hours, and minutes.
- **BIOS version:** BIOS version.

### **View real-time appliance throughput**

The total throughput of the SDX appliance for incoming and outgoing traffic is plotted in real time in a graph that is updated at regular intervals. By default, throughputs for both incoming and outgoing traffic are plotted together on the graph.

To view the throughput of the SDX appliance, on the GUI click **Dashboard** and check **System Throughput (Mbps)**.

### **View real-time CPU and memory usage**

You can view a graph of CPU and memory usage of the appliance. The graph is plotted in real time and updated at regular intervals.

To view the CPU and memory usage of the SDX appliance, on the GUI click **Dashboard** and check **Management Service Statistics**.

### **View CPU usage for all cores**

You can view the usage of each CPU core on the SDX appliance.

The **CPU Core Usage** pane displays the following details:

- **Core Number:** The CPU core number on the appliance.
- **Physical CPU:** The physical CPU number of that core.
- **Hyper Threads:** The hyper threads associated with that CPU core.

- **Instances:** The instances that are using that CPU core.
- **Average Core Usage:** The average core usage, expressed as a percentage.

To view the CPU usage for all the cores on the SDX appliance, on the GUI click **Dashboard** and check **System CPU Usage (%)**.

### **Install an SSL certificate on the SDX appliance**

The SDX appliance is shipped with a default SSL certificate. For security reasons, you might want to replace this certificate with your own SSL certificate. To do so, you must first upload your SSL certificate to the Management Service and then install the certificate. Installing an SSL certificate terminates all current client sessions with the Management Service. Log on to the Management Service for any additional configuration tasks.

To install an SSL certificate, click **System**. In the **Set Up Appliance** group, click **Install SSL Certificate** and enter the details in the wizard.

### **View the SSL certificate on the Management Service**

The Management Service uses an SSL certificate for secure client connections. View the details of this certificate, such as validity status, issuer, subject, days to expire, valid from and to dates, version, and serial number.

To view the SSL certificate, click **System** and in the **Set Up Appliance** group, click **View SSL Certificate**.

### **SSL certificates and keys for NetScaler instances**

Separate views of SSL certificates and keys for NetScaler instances provide enhanced usability. Use a new Management Service node, SSL Certificate Files, to upload and manage the SSL certificates and corresponding public and private key pairs that can be installed on NetScaler instances.

To access the SSL certificates and keys for NetScaler instances, navigate to **Configuration > NetScaler > SSL Certificate Files**.

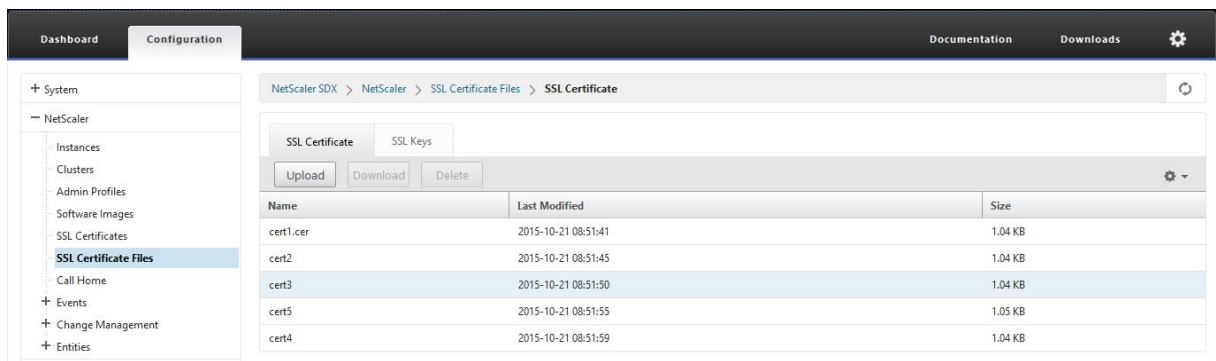

## Modify system settings

For security reasons, you can specify that the Management Service and a VPX instance must communicate with each other only over a secure channel. You can also restrict access to the Management Service user interface. Clients can log on the Management Service user interface only by using https.

To modify system settings, click **Configuration > System** and in the System Settings group, click **Change System Settings**.

## Restart the appliance

The Management Service provides an option to restart the SDX appliance. During the restart, the appliance shuts down all hosted instances, and then restarts the Citrix Hypervisor. When the Citrix Hypervisor restarts, it starts all hosted instances along with the Management Service.

To restart the appliance, click **Configuration > System** and in the System Administration group, click **Reboot Appliance**.

## Shut down the appliance

You can shut down the SDX appliance from the Management Service.

To shut down the appliance, click **Configuration > System**, and in the System Administration group, click **Shut Down Appliance**.

## SDX administrative domains

August 1, 2023

SDX administrative domains feature helps you to create multiple administrative domains. You can use the administrative domains to segregate resources for different departments. Administrative domains can therefore improve control over resources, and the resources can be distributed among various domains for optimal use.

An SDX appliance is shipped with fixed resources, such as CPU cores, data throughput, memory, disk space, SSL chips, and a specific number of instances that can be provisioned. The number of instances that you can create depends on the license.

An SDX appliance supports up to three levels of administrative domains. When the appliance is shipped, all the resources are allocated to the owner.

Any administrative domains that you create are subdomains of the owner domain. In each case, the subdomain's resources are allocated from the parent domain's pool of resources. The users in an administrative domain have access to that domain's resources. They do not have access to the resources of other domains at the same hierarchical level, nor to the parent-domain resources that have not been allocated to their domain. However, users in a parent domain can access the resources of that domain's subdomains.

### Examples of allocating resources to subdomains

Table 1 lists the resources of the default root domain. The SDX administrator can allocate these resources to subdomains. In this case, the administrator can allocate a maximum of, for example, 10 CPU cores and 840 GB of disk space.

Table 1. Owner Resources

---

CPU core	10
Throughput (Mbps)	18500
Memory (MB)	87300
Disk Space (GB)	840
SSL Chips	36
Instances	36

---

Table 2 lists the resources allocated a subdomain named *Test*. This subdomain has been allocated 5 of its parent domain's 10 CPU cores, leaving 5 cores that can be allocated to other subdomains of the Owner.

Table 2. Test Domain's Resources

---

CPU core	5
Throughput (Mbps)	1024
Memory (MB)	2048
Disk Space (GB)	40
SSL Chips	8
Instances	4

---

When creating subdomains, the *Test* domain administrator can allocate only the resources listed in Table 2. The *Test* domain can have only one level of subdomains, because only three levels of domains can be created.

The following figure shows another example of resource allocation among subdomains, using different values from the ones listed in tables 1 and 2.

To create an administrative domain, navigate to **Configuration > System > Administrative Domain** and select the options that you want. Follow the on-screen instructions. Once a new domain is created, log in to this domain by using the Management Service's login page and provide the domain name and user name. For example, if you created a domain named *NewDomain* with a user *NewUser* then login as *NewDomain\NewUser*.

### Assign users to domains

When a subdomain is created, two user groups are automatically created: an admin group and a read-only group. By default, each user is the part of the admin group. A user can be added to multiple groups.

## Managing RAID disk allocation on the SDX 22000 platform

August 1, 2023

NetScaler SDX 22040/22060/22080/22100/22120 appliances now include a Redundant Array of Independent Disks (RAID) controller, which can support up to eight physical disks. Multiple disks provide not only performance gains, but also enhanced reliability. Reliability is especially important for an SDX appliance, because the appliance hosts many virtual machines, and a disk failure affects multiple virtual machines. The RAID controller on the Management Service supports the RAID 1 configuration,

which implements disk mirroring. That is, two disks maintain the same data. If a disk in the RAID 1 array fails, its mirror immediately supplies all needed data.

RAID 1 disk mirroring combines two physical drives in one logical drive. The usable capacity of a logical drive is equivalent to the capacity of one of its physical drives. Combining two 1-terabyte drives, for example, creates a single logical drive with a total usable capacity of 1 terabyte. This combination of drives appears to the appliance as a single logical drive.

The SDX appliance is shipped with a configuration that includes logical drive 0 and logical drive 1. Logical drive 0 is allocated for the Management Service and the Citrix Hypervisor and logical drive 1 is allocated for the NetScaler instances that you provision. To use more physical drives, you have to create new logical drives.

## View drive properties and operations

An SDX appliance supports a maximum of eight physical-drive slots, that is, a pair of four slots on each side of the appliance. You can insert physical drives into the slots. Before you can use a physical drive, you must make it part of a logical drive.

In the Management Service, the **Configuration > System > RAID** screen includes tabs for logical drives, physical drives, and storage repositories.

### Logical drives

On the **Configuration > System > RAID > Logical Drives** tab, you can view the name, state, size, of each logical drive, and information about its component physical drives. The following table describes the states of the virtual drive.

---

State	Description
Optimal	The virtual drive operating condition is good. All configured drives are online.
Degraded	The virtual drive operating condition is not optimal. One of the configured drives has failed or is offline.
Failed	The virtual drive has failed.
Offline	The virtual drive is not available to the RAID controller.

---

You can also view the details the physical drives associated with the logical drive by selecting the logical drive and clicking **Show Physical Drive**.

### To create a new logical drive

1. Navigate to **Configuration > System > RAID**, and select the **Logical Drives** tab.
2. Click **Add**.
3. In the **Create Logical Disk** dialog box, select two slots that contain operational physical drives, and then click **Create**.

### Physical drives

An SDX appliance supports a maximum of eight physical slots, that is, a pair of four slots on each side of the appliance. On the

**Configuration > System > RAID > Physical Drives** tab, you can view the following information:

- **Slot:**—Physical slot associated with the physical drive.
- **Size:**—Size of the physical drive.
- **Firmware State:**—State of the firmware. Possible Values:
  - **Online, spun up:**—Physical drive is up and is being controlled by RAID.
  - **Unconfigured (good):**—Physical drive is in good condition and can be added as a part of the logical drive pair.
  - **Unconfigured (bad):**—Physical drive is not in good condition and cannot be added as part of a logical drive.
- **Foreign State:**—Indicates if the disk is empty.
- **Logical Drive:**—Associated logical drive.

In the **Physical Drives** pane, you can perform the following actions on the physical drives:

- **Initialize:**—Initialize the disk. You can initialize the physical drive if it is not in good state and must be added as a part of the logical drive pair.
- **Rebuild:**—Initiate a rebuild of the drive. When a drive in a drive group fails, you can rebuild the drive by re-creating the data that was stored on the drive before it failed. The RAID controller re-creates the data stored on the other drives in the drive group.
- **Locate:**—Locate the drive on the appliance, indicated by causing the Drive Activity LED associated with the drive to blink.
- **Stop Locate:**—Stop locating the drive on the appliance.
- **Prepare to Remove:**—Deactivate the selected physical drive so that it can be removed.

### Storage repository

On the **Configuration > System > RAID > Storage Repository** tab, you can view the status of storage repositories on the SDX appliance. You can also view information about a storage-repository drive



that is not attached, and you can remove such a drive by selecting it and then clicking **Remove**. The **Storage Repository** tab displays the following information about each storage repository:

- **Name:**—Name of the storage repository drive.
- **Is Drive Attached:**—Whether the storage repository is attached or not. If the drive is not attached, you can click **Remove** to delete.
- **Size:**—Size of the storage repository.
- **Utilized:**—Amount of storage-repository space in use.

**Add a logical drive to the SDX 22000 appliance** To add an extra logical drive to the SDX 22000 platform:

1. Log on to the Management Service.
2. Navigate to **Configuration > System > RAID**.
3. On the back of the SDX 22000 appliance, insert the two blank SSDs in slot numbers 4 and 5. You can add the SSDs in a running system.  
**Note:** Make sure that the SSDs are NetScaler certified.
4. In the Management Service, navigate to **Configuration > System > RAID** and the **Physical Drives** tab. You would see the SSDs that you added.
5. Navigate to the **Logical Drive** tab and click **Add**.
6. In the **Create Logical Disk** page:
  - a) In the **First Slot** drop-down list, select 4.
  - b) In the **Second Slot** drop-down list, select 5.
  - c) Click **Create**.

**Note:** In Management Service, the slot number begins with zero. So the slot numbering in Management Service differs from the slot numbering on the physical appliance.

The logical drive is created and is listed under the **Logical Drive tab**. Click the refresh icon to update the order of the logical drives.

**Add a second logical drive on the SDX 22000 appliance** To add another logical drive, insert the SSDs in slot numbers 6 and 7. In the **Create Logical Disk** page, select 6 from the **First Slot** list, and select 7 from the **Second Slot** list.

**Replace a defective SSD drive with a blank SSD drive** To replace a defective SSD drive with a blank SSD drive:

1. Navigate to **Configuration > System > RAID**.
2. On the **Physical Drives** tab, select the defective drive that you want to replace.

3. Click **Prepare to Remove** to remove the drive.
4. Click the refresh icon to refresh the list of physical drives.
5. Physically remove the defective drive from the slot.
6. Insert the new Citrix verified SSD in the slot from where you removed the defective SSD.
7. In the Management Service, navigate to **Configuration > System > RAID**. The new SSD is listed in the **Physical Drives** section. The drive rebuild process starts automatically.

Click the refresh icon to check the status of the rebuild process. When the rebuild process is complete, you can see Online, Spun Up status in the **Firmware State** column.

## SDX Licensing Overview

December 12, 2023

In the NetScaler SDX Management Service, you can use your hardware serial number (HSN) or your license access code to allocate your licenses. The Management Service software internally fetches the serial number of your appliance, and Citrix sends the license access code by email when you purchase a license.

Alternatively, if a license is already present on your local computer, you can upload it to the appliance.

For all other functionality, such as returning or reallocating your license, you must use the licensing portal. Optionally, you can still use the licensing portal for license allocation. For more information, see [Manage Licenses on citrix.com](#).

For information about SDX licensing options, see:

- [Choosing the right platform and edition options](#).
- [Licensing models](#)

**Note:** Installing a perpetual or pooled license doesn't require a reboot of the SDX appliance.

### Prerequisites

To use the hardware serial number or license access code to allocate your licenses:

1. You must be able to access public domains through the appliance. For example, the appliance must be able to access [www.citrix.com](http://www.citrix.com). The license allocation software internally accesses the Citrix licensing portal for your license. To access a public domain, you must configure the Management Service IP address and set up a DNS server.
2. Your license must be linked to your hardware, or you must have a valid license access code.

## Allocating your license by using the Management Service

If your license is already linked to your hardware, the license allocation process can use the hardware serial number. Otherwise, you must type the license access code.

You can partially allocate licenses as required for your deployment. For example, if your license file contains 10 licenses, but your current requirement is for only six licenses, you can allocate six licenses now, and allocate more licenses later. You cannot allocate more than the total number of licenses present in your license file.

### To allocate your license

1. In a web browser, type the IP address of the Management Service of the SDX appliance (for example, <http://10.102.126.251>).
2. In **User Name** and **Password**, type the administrator credentials.
3. On the **Configuration** tab, navigate to **System > Licenses**.
4. In the details pane, click **Add License File**.

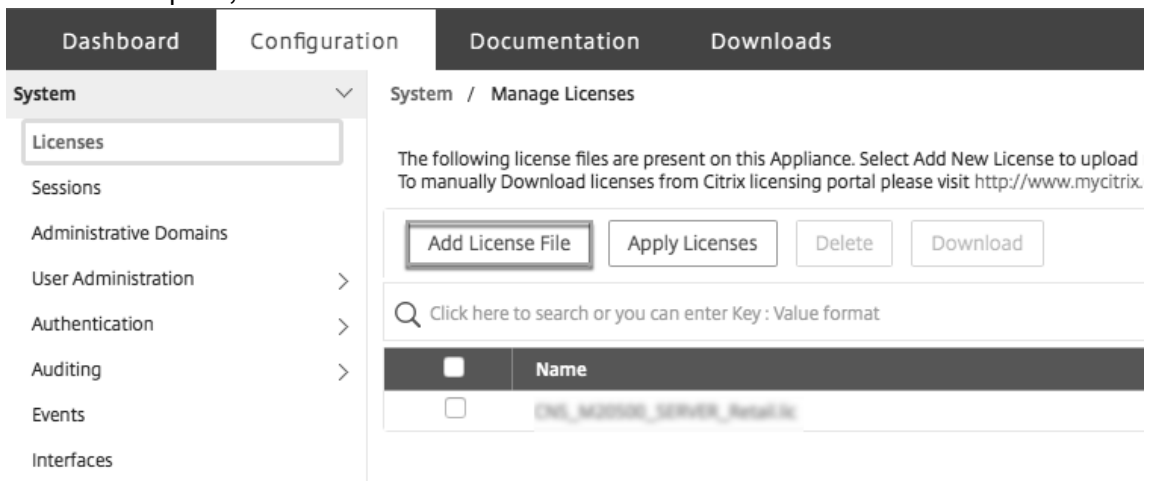

5. Next, select one of the options:
  - Upload license files from a local computer (this option is selected by default)
  - Use license access code
  - Use hardware serial number

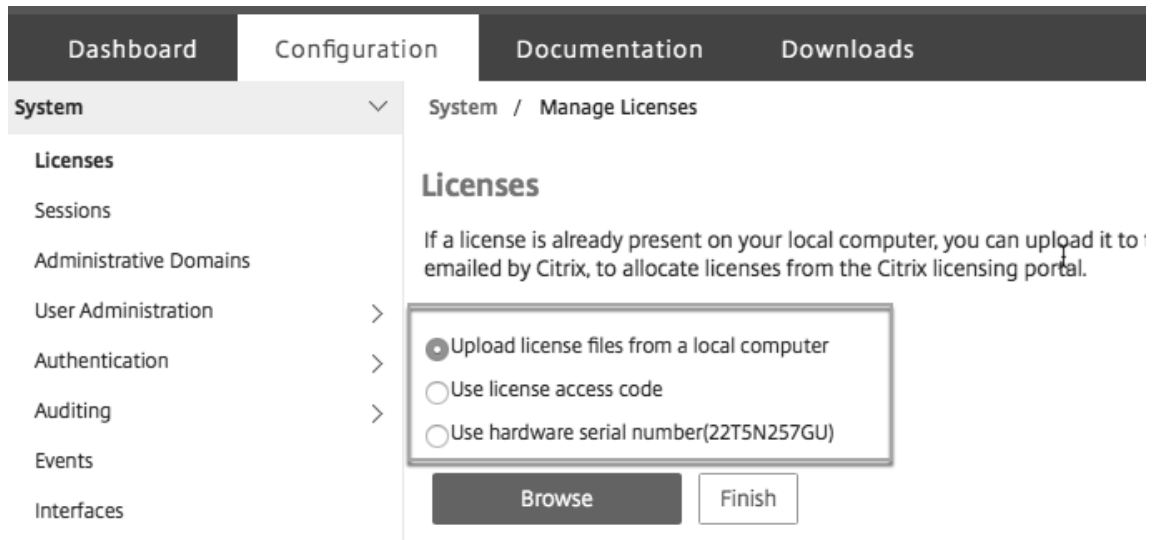

- **Upload license files from a local computer:** If you choose this option, click **Browse** to select the zero-capacity license from your local machine. Then, click **Finish**.
  1. Once the zero-capacity license is applied successfully, **License Mode** section appears on the **Licenses** page.
  2. You can choose either **Pooled Licenses** or **Self Managed Pool Licenses**.
  3. In the **Licensing Server Name or IP Address** field, enter the license server details.
  4. In the **Port Number** field, enter the license server port. Default value: 27000.
  5. Click **Get Licenses**.
  6. In the **Allocate Licenses** window, specify the required instances and bandwidth, and click **Allocate**.
  7. On the **Manage Licenses** page, you can view the details of the license server, license edition, and the allocated instances and bandwidth from the pool.

**Note:**

From NetScaler release 13.1 build 30.x onwards, NetScaler SDX appliance supports Self Managed Pool license. With this license, you can simplify and automate license file uploads to the license server. You can use NetScaler Console to create a licensing framework that comprises a common bandwidth or vCPU and instance pool.

- **Use license access code:** If you select this option, either provide the **LAC** in the **License Access Code** field, or select the check box to connect through a proxy server. Next, click **Get Licenses**.
  - Select the license file that you want to use to allocate your licenses.
  - In the **Allocate** column, enter the number of licenses to be allocated. Next, click **Download**.

If the license is downloaded, it appears under **License Files**. Select the license file and click **Apply Licenses**.

- **Use hardware serial number:** If you choose this option, the software internally fetches the serial number of your appliance and uses this number to display your licenses.
  - Click **Get Licenses**, or select the check box for **Connect through Proxy Server** and then click **Get Licenses**.

After you've downloaded the license file, select the license file and click **Apply Licenses**.

For information about pooled licensing, see [Upgrade a perpetual license in a NetScaler SDX to NetScaler pooled capacity](#).

## SDX resource visualizer

December 12, 2023

When a NetScaler instance is provisioned on a NetScaler SDX appliance, various resources such as CPU, throughput, memory need to be allocated to an instance. With current SDX, the information about various available resources is not displayed.

Using the resource visualizer, all the available resource which can be used to provision an instance are displayed in a single dashboard. All the available and used resources are shown in a graphical format. Resource visualizer also displays other parameters such as power supply status and temperature, apart from the resources that can be allocated.

The resource visualizer also displays the various resources that an instance is using. To see the various resources associated with an instance, click the instance name in the visualizer. The right hand side of the visualizer displays all the available and used resources in a graphical format.

The following illustration shows the details captured in the resource visualizer:

## Manage interfaces

August 1, 2023

In the **Interfaces** pane, you can display the mapping of the virtual interfaces on the VPX instances to the SDX appliance, and assign MAC addresses to the interfaces.

**Note:** Autonegotiation is not supported on an interface to which a direct attach cable (DAC) is connected.

In the list of Interfaces in the **Interfaces** pane, in the **State** column, UP indicates that the interface is receiving traffic normally. DOWN indicates a network issue because of which the interface is unable to send or receive traffic.

**Important:** Flow control is not recommended from connections over 1 GB.

### To configure an interface

1. On the **Configuration** tab, in the navigation pane, expand **System**, and then click **Interfaces**.

2. In the **Interfaces** pane, click the interface that you want to configure, and then click **Edit**.
3. In the **Configure Interface** window, specify values for the following parameters:
  - **Auto Negotiation**—Enable auto-negotiation. Possible values: ON, OFF. Default: ON.
  - **Speed**—Ethernet speed for the interface, in Mb/s. Possible values: 10, 100, 1000, and 10000.
  - **Duplex**—Type of duplex operation of the interface. Possible values: Full, Half, NONE. Default: NONE.
  - **Flow Control Auto Negotiation**—Automatically negotiate flow control parameters. Possible values: ON, OFF. Default: ON
  - **Rx Flow Control**—Enable Rx flow control. Possible values: ON, OFF. Default: ON
  - **Tx Flow Control**—Enable Tx flow control. Possible values: ON, OFF. Default: ON
4. Click **OK**, and then click **Close**.

### To reset the parameters of an interface to their default values

1. On the **Configuration** tab, in the navigation pane, expand **System**, and then click **Interfaces**.
2. In the **Interfaces** pane, click the interface that you want to reset, and then click **Reset**.

### Display the mapping of virtual interfaces on the VPX instance to the physical interfaces

In the NetScaler VPX instance, the GUI and the CLI display the mapping of the virtual interfaces on the instance to the physical interfaces on the appliance.

After logging on to the VPX instance, in the configuration utility, navigate to **Network**, and then click **Interfaces**. The virtual interface number on the instance and the corresponding physical interface number on the appliance appear in the **Description** field, as shown in the following figure:

In the CLI, type the `show interface` command. For example:

```

1 > show interface
2 1) Interface 10/3 (10G VF Interface, PF 10/4) #2
3 flags=0xe460 <ENABLED, UP, UP, HAMON, 802.1q>
4 MTU=1500, native vlan=1, MAC=6e:b6:f5:21:5d:db, uptime 43h03m35s
5 Actual: media FIBER, speed 10000, duplex FULL, fctl NONE, throughput
6 10000
7 RX: Pkts(2547925) Bytes(287996153) Errs(0) Drops(527183) Stalls(0)
8 TX: Pkts(196) Bytes(8532) Errs(0) Drops(0) Stalls(0)
9 NIC: InDisc(0) OutDisc(0) Fctls(0) Stalls(0) Hangs(0) Muted(0)
10 Bandwidth thresholds are not set.
11 ...
12 <!--NeedCopy-->
```

## Assigning a MAC address to an interface

While you are provisioning an ADC instance on an SDX appliance, the Citrix Hypervisor internally assigns a MAC address to a virtual interface associated with that instance. The same MAC address might be assigned to a virtual interface associated with another instance on the same appliance or on another appliance. To prevent the assignment of duplicate MAC addresses, you can enforce unique MAC addresses.

There are two ways of assigning a MAC address to an interface:

1. Assign a base MAC address and a range to an interface: The Management Service assigns a unique MAC address by using the base address and range.
2. Assign a global base MAC address: A global base MAC address applies to all interfaces. The Management Service then generates the MAC addresses for all interfaces. If you set the global base MAC address, the range for a 1G interface is set to 8. The range for a 10G interface is set to 64. See the following table for sample base MAC addresses if the global base MAC address is set to 00:00:00:00:00:00.

Physical Interface	Base MAC Address
0/1	00:00:00:00:00:00
0/2	00:00:00:00:00:08
1/1	00:00:00:00:00:10
1/2	00:00:00:00:00:18
1/3	00:00:00:00:00:20
1/4	00:00:00:00:00:28
1/5	00:00:00:00:00:30
1/6	00:00:00:00:00:38
1/7	00:00:00:00:00:40
1/8	00:00:00:00:00:48
10/1	00:00:00:00:00:50
10/2	00:00:00:00:00:90

Table 1. Example of Base MAC Addresses Generated from a Global Base MAC Address

The base MAC address for the management ports is for reference only. The Management Service generates MAC addresses, based on the base MAC address, for 1/x and 10/x ports only.

Note: You cannot assign a base MAC address to a channel.



To perform the various operations with MAC address, click **System > Interfaces**. Select an interface and then click **Edit**. Perform the MAC address operation, in the **Configure Interface** window.

### **Disable or enable the physical interfaces on the SDX appliance**

If you are not using any of the physical interfaces on the SDX appliance, you can disable the physical interface using the Management Service. This action is helpful for security purposes.

Note: By default, all the physical interfaces on the SDX appliance are enabled. Also, if an interface is used by a VPX or channel, you cannot disable the interface.

#### **To disable the physical interface:**

1. On the **Configuration** tab, in the navigation pane, expand **System**, and then click **Interfaces**.
2. In the **Interfaces** pane, select the interface that you want to disable.
3. In the **Action** drop-down list, click **Disable**.

If you want to use the disabled physical interface, you can enable the interface using the Management Service.

#### **To enable the disabled physical interface:**

1. On the **Configuration** tab, in the navigation pane, expand **System**, and then click **Interfaces**.
2. In the **Interfaces** pane, select the disable interface that you want to enable.
3. In the **Action** drop-down list, click **Enable**.

## **Jumbo Frames on SDX Appliances**

August 1, 2023

NetScaler SDX appliances support receiving and transmitting jumbo frames containing up to 9216 bytes of IP data. Jumbo frames can transfer large files more efficiently than it is possible with the standard IP MTU size of 1500 bytes.

A NetScaler SDX appliance can use jumbo frames in the following deployment scenarios:

- **Jumbo to Jumbo:** The appliance receives data as jumbo frames and sends it as jumbo frames.
- **Non-Jumbo to Jumbo:** The appliance receives data as non-jumbo frames and sends it as jumbo frames.
- **Jumbo to Non-Jumbo:** The appliance receives data as jumbo frames and sends it as non-jumbo frames.

The NetScaler instances provisioned on SDX appliance support jumbo frames in a load balancing configuration for the following protocols:

- TCP
- Any other protocol over TCP
- SIP

For more information about jumbo frames, see the use cases.

### Use Case: Jumbo to Jumbo Setup

Consider an example of a jumbo to jumbo setup in which SIP load balancing virtual server LBVS-1, configured on NetScaler instance NS1, is used to load balance SIP traffic across servers S1 and S2. The connection between client CL1 and NS1, and the connection between NS1 and the servers support jumbo frames.

Interface 10/1 of NS1 receives or sends traffic from or to client CL1. Interface 10/2 of NS1 receives or sends traffic from or to server S1 or S2. Interfaces 10/1 and 10/2 of NS1 are part of VLAN 10 and VLAN 20, respectively.

For supporting jumbo frames, the MTU is set to 9216 for interfaces 10/1, 10/2, and VLANs VLAN 10, VLAN 20.

All other network devices, including CL1, S1, S2, in this setup example are also configured for supporting jumbo frames.

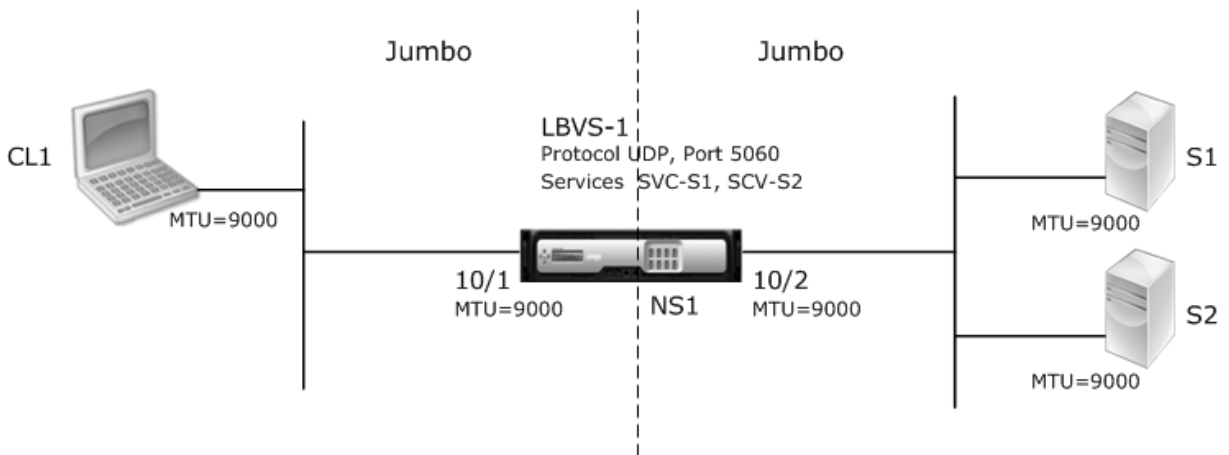

The following table lists the settings used in the example.

Entity	Name	Details
IP address of client CL1	CL1	192.0.2.10

Entity	Name	Details
IP address of servers	S1	198.51.100.19
		S2
MTUs specified for interfaces (by using the Management Service interface) and VLANs on NS1 (by using the CLI).	10/1	9000
		10/2
		VLAN 10
		VLAN 20
Services on NS1 representing servers	SVC-S1	IP address: 198.51.100.19; Protocol: SIP; Port: 5060
Services on NS1 representing servers	SVC-S2	IP address: 198.51.100.20; Protocol: SIP; Port: 5060
Load balancing virtual server on VLAN 10	LBVS-1	IP address: 203.0.113.15; Protocol: SIP; Port: 5060;SVC-S1, SVC-S2

Following is the traffic flow of CL1's request to NS1:

1. CL1 creates a 20000-byte SIP request for LBVS1.
2. CL1 sends the request data in IP fragments to LBVS1 of NS1. The size of each IP fragment is either equal to or less than the MTU (9000) set on the interface from which CL1 sends these fragments to NS1.
  - Size of the first IP fragment = [IP header + UDP header + SIP data segment] = [20 + 8 + 8972] = 9000
  - Size of the second IP fragment = [IP header + SIP data segment] = [20 + 8980] = 9000
  - Size of the last IP fragment=[IP header + SIP data segment] = [20 + 2048] = 2068
3. NS1 receives the request IP fragments at interface 10/1. NS1 accepts these fragments, because the size of each of these fragments is equal to or less than the MTU (9000) of interface 10/1.
4. NS1 reassembles these IP fragments to form the 27000-byte SIP request. NS1 processes this request.
5. LBVS-1's load balancing algorithm selects server S1.
6. NS1 sends the request data in IP fragments to S1. The size of each IP fragment is either equal or less than the MTU (9000) of the interface 10/2, from which NS1 sends these fragments to S1. The IP packets are sourced with a SNIP address of NS1.

- Size of the first IP fragment = [IP header + UDP header + SIP data segment] = [20 + 8 + 8972] = 9000
- Size of the second IP fragment = [IP header + SIP data segment] = [20 + 8980] = 9000
- Size of the last IP fragment=[IP header + SIP data segment] = [20 + 2048] = 2068

Following is the traffic flow of S1's response to CL1 in this example:

1. Server S1 creates a 30000-byte SIP response to send to the SNIP address of NS1.
2. S1 sends the response data in IP fragments to NS1. The size of each IP fragment is either equal to or less than the MTU (9000) set on the interface from which S1 sends these fragments to NS1.
  - Size of the first IP fragment = [IP header + UDP header + SIP data segment] = [20 + 8 + 8972] = 9000
  - Size of the second and third IP fragment = [IP header + SIP data segment] = [20 + 8980] = 9000
  - Size of the last IP fragment=[IP header + SIP data segment] = [20 + 3068] = 3088
3. NS1 receives the response IP fragments at interface 10/2. NS1 accepts these fragments, because the size of each fragment is equal to or less than the MTU (9000) of interface 10/2.
4. NS1 reassembles these IP fragments to form the 27000-byte SIP response. NS1 processes this response.
5. NS1 sends the response data in IP fragments to CL1. The size of each IP fragment is either equal or less than the MTU (9000) of the interface 10/1, from which NS1 sends these fragments to CL1. The IP fragments are sourced with LBVS-1's IP address. These IP packets are sourced from LBVS-1's IP address and destined to CL1's IP address.
  - Size of the first IP fragment = [IP header + UDP header + SIP data segment] = [20 + 8 + 8972] = 9000
  - Size of the second and third IP fragment = [IP header + SIP data segment] = [20 + 8980] = 9000

Size of the last IP fragment=[IP header + SIP data segment] = [20 + 3068] = 3088

### Configuration Tasks:

On the SDX Management Service, navigate to **Configuration > System > Interfaces** page. Select the required interface and click **Edit**. Set the MTU value and click **OK**.

### Example:

Set the MTU value for interface 10/1 as 9000 and for interface 10/2 as 9000.

Log on to the NetScaler instance and use the ADC command line interface to complete the remaining configuration steps.

The following table lists the tasks, commands, and examples for creating the required configuration on the NetScaler instances.

Tasks	ADC Command Syntax	Examples
Create VLANs and set the MTU of the desired VLANs for supporting jumbo frames.	<code>add vlan &lt;id&gt; -mtu &lt;positive_integer&gt;;show vlan &lt;id&gt;</code>	<code>add vlan 10 -mtu 9000; add vlan 20 -mtu 9000</code>
Bind interfaces to VLANs.	<code>bind vlan &lt;id&gt; -ifnum &lt;interface_name&gt;; show vlan &lt;id&gt;</code>	<code>bind vlan 10 -ifnum 10/1; bind vlan 20 -ifnum 10/2</code>
Add a SNIP address.	<code>add ns ip &lt;IPAddress&gt; &lt;netmask&gt; -type SNIP; show ns ip</code>	<code>add ns ip 198.51.100.18 255.255.255.0 -type SNIP</code>
Create services representing SIP servers.	<code>add service &lt;serviceName&gt; &lt;ip&gt; SIP_UDP &lt;port&gt;; show service &lt;name&gt;</code>	<code>add service SVC-S1 198.51.100.19 SIP_UDP 5060; dd service SVC-S2 198.51.100.20 SIP_UDP 5060</code>
Create SIP load balancing virtual servers and bind the services to it	<code>add lb vserver &lt;name&gt; SIP_UDP &lt;ip&gt; &lt;port&gt;; bind lb vserver &lt;vserverName&gt; &lt;serviceName&gt;; show lb vserver &lt;name&gt;</code>	<code>add lb vserver LBVS-1 SIP_UDP 203.0.113.15 5060; bind lb vserver LBVS-1 SVC-S1;bind lb vserver LBVS-1 SVC-S2</code>
<code>bind lb vserver LBVS-1 SVC-S2</code>	<code>save ns config;show ns config</code>	

### Use Case: Non-Jumbo to Jumbo Setup

Consider an example of a non-jumbo to jumbo setup in which the load balancing virtual server LBVS1, configured on a NetScaler instance NS1, is used to load balance traffic across servers S1 and S2. The connection between client CL1 and NS1 supports non-jumbo frames, and the connection between NS1 and the servers supports jumbo frames.

Interface 10/1 of NS1 receives or sends traffic from or to client CL1. Interface 10/2 of NS1 receives or sends traffic from or to server S1 or S2.

Interfaces 10/1 and 10/2 of NS1 are part of VLAN 10 and VLAN 20, respectively. For supporting only

non-jumbo frames between CL1 and NS1, the MTU is set to the default value of 1500 for both interface 10/1 and VLAN 10.

For supporting jumbo frames between NS1 and the servers, the MTU is set to 9000 for interface 10/2 and VLAN 20.

Servers and all other network devices between NS1 and the servers are also configured for supporting jumbo frames. Since HTTP traffic is based on TCP, MSSs are set accordingly at each end point for supporting jumbo frames:

- For the connection between CL1 and virtual server LBVS1 of NS1, the MSS on NS1 is set in a TCP profile, which is then bound to LBVS1.
- For the connection between a SNIP address of NS1 and S1, the MSS on NS1 is set in a TCP profile, which is then bound to the service (SVC-S1) representing S1 on NS1.

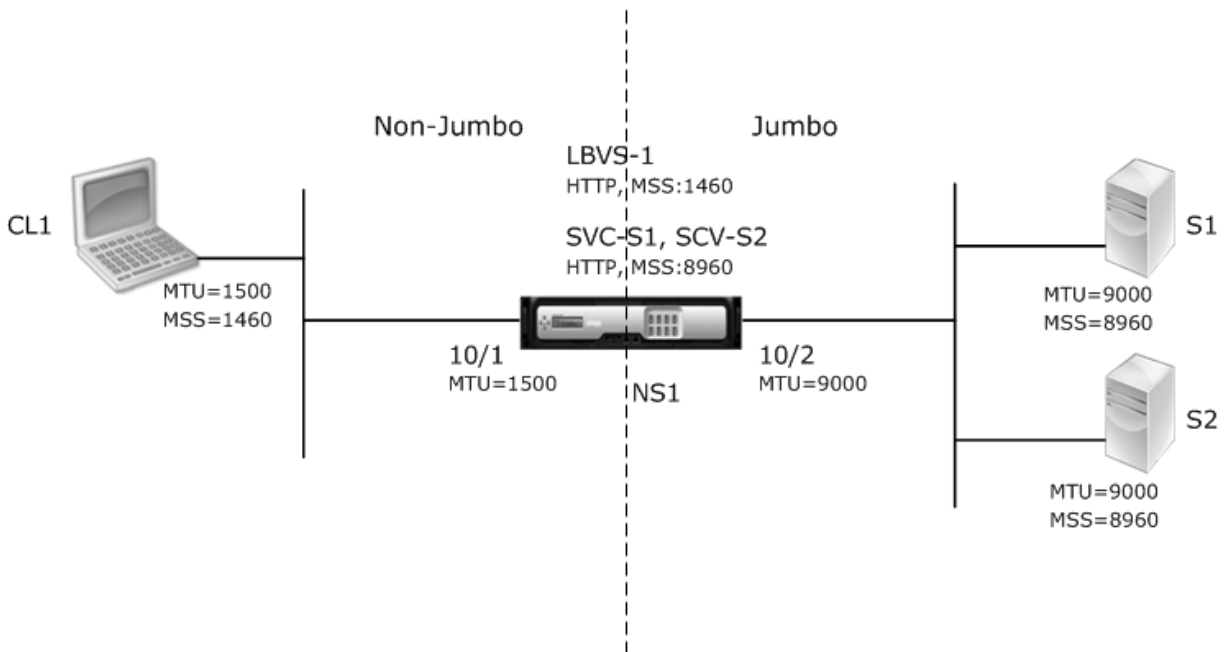

The following table lists the settings used in this example:

Entity	Name	Details
IP address of client CL1	CL1	192.0.2.10
IP address of servers	S1	198.51.100.19
	S2	
MTU for interface 10/1 (by using the Management Service interface).		1500
MTU set for interface 10/2 (by using the Management Service interface).		9000

Entity	Name	Details
MTU for VLAN 10 on NS1 (by using the ADC command line interface).		1500
MTU set for VLAN 20 on NS1 (by using the ADC command line interface).		9000
Services on NS1 representing servers	SVC-S1	IP address: 198.51.100.19; Protocol: HTTP; Port: 80; MSS: 8960 SVC-S2
Load balancing virtual server on VLAN 10	LBVS-1	IP address: 203.0.113.15; Protocol: HTTP; Port: 80. Bound services: SVC-S1, SVC-S2; MSS: 1460

Following is the traffic flow of CL1's request to S1 in this example:

1. Client CL1 creates a 200-byte HTTP request to send to virtual server LBVS-1 of NS1.
2. CL1 opens a connection to LBVS-1 of NS1. CL1 and NS1 exchange their respective TCP MSS values while establishing the connection.
3. Because NS1's MSS is larger than the HTTP request, CL1 sends the request data in a single IP packet to NS1.

1.

```

1 <div id="concept_57AEA1C9D3DA47948B6D834341388D29__d978e142">
2
3 Size of the request packet = [IP Header + TCP Header + TCP Request
4                               ] = [20 + 20 + 200] = 240
5 </div>
```

4. NS1 receives the request packet at interface 10/1 and then processes the HTTP request data in the packet.
5. LBVS-1's load balancing algorithm selects server S1, and NS1 opens a connection between one of its SNIP addresses and S1. NS1 and CL1 exchange their respective TCP MSS values while establishing the connection.
6. Because S1's MSS is larger than the HTTP request, NS1 sends the request data in a single IP packet to S1.
  - a) Size of the request packet = [IP Header + TCP Header + [TCP Request] = [20 + 20 + 200] = 240

Following is the traffic flow of S1's response to CL1 in this example:

1. Server S1 creates an 18000-byte HTTP response to send to the SNIP address of NS1.
2. S1 segments the response data into multiples of NS1's MSS and sends these segments in IP packets to NS1. These IP packets are sourced from S1's IP address and destined to the SNIP address of NS1.
  - Size of the first two packet = [IP Header + TCP Header + (TCP segment=NS1's MSS size)] = [20 + 20 + 8960] = 9000
  - Size of the last packet = [IP Header + TCP Header + (remaining TCP segment)] = [20 + 20 + 2080] = 2120
3. NS1 receives the response packets at interface 10/2.
4. From these IP packets, NS1 assembles all the TCP segments to form the HTTP response data of 18000 bytes. NS1 processes this response.
5. NS1 segments the response data into multiples of CL1's MSS and sends these segments in IP packets, from interface 10/1, to CL1. These IP packets are sourced from LBVS-1's IP address and destined to CL1's IP address.
  - Size of all the packet except the last = [IP Header + TCP Header + (TCP payload=CL1's MSS size)] = [20 + 20 + 1460] = 1500
  - Size of the last packet = [IP Header + TCP Header + (remaining TCP segment)] = [20 + 20 + 480] = 520

### Configuration Tasks:

On the SDX Management Service, navigate to **Configuration > System > Interfaces** page. Select the required interface and click **Edit**. Set the MTU value and click **OK**.

### Example:

Set the following MTU values:

- For 10/1 interface as 1500
- For 10/2 interface as 9000

Log on to the NetScaler instance and use the ADC command line interface to complete the remaining configuration steps.

The following table lists the tasks, commands, and examples for creating the required configuration on the NetScaler instances.



Tasks	ADC Command Line Syntax	Example
Create VLANs and set the MTU of the desired VLANs for supporting jumbo frames.	<pre>add vlan &lt;id&gt; -mtu &lt; positive_integer&gt;; show vlan &lt;id&gt;</pre>	<pre>add vlan 10 -mtu 1500; add vlan 20 -mtu 9000</pre>
Bind interfaces to VLANs.	<pre>bind vlan &lt;id&gt; -ifnum &lt;interface_name&gt;; show vlan &lt;id&gt;</pre>	<pre>bind vlan 10 -ifnum 10/1; bind vlan 20 -ifnum 10/2</pre>
Add a SNIP address.	<pre>add ns ip &lt;IPAddress&gt; &lt;netmask&gt; -type SNIP; show ns ip</pre>	<pre>add ns ip 198.51.100.18 255.255.255.0 -type SNIP</pre>
Create services representing HTTP servers	<pre>add service &lt; serviceName&gt; &lt;ip&gt; HTTP &lt;port&gt;; show service &lt;name&gt;</pre>	<pre>add service SVC-S1 198.51.100.19 http 80; add service SVC-S2 198.51.100.20 http 80</pre>
Create HTTP load balancing virtual servers and bind the services to it	<pre>add lb vserver &lt;name&gt; HTTP &lt;ip&gt; &lt;port&gt;; bind lb vserver &lt; vserverName&gt; &lt; serviceName&gt;; show lb vserver &lt;name &gt;</pre>	<pre>add lb vserver LBVS-1 http 203.0.113.15 80; bind lb vserver LBVS -1 SVC-S1</pre>
Create a custom TCP profile and set its MSS for supporting jumbo frames.	<pre>add tcpProfile &lt;name&gt; -mss &lt; positive_integer&gt;; show tcpProfile &lt;name &gt;</pre>	<pre>add tcpprofile NS1- SERVERS-JUMBO -mss 8960</pre>
Bind the custom TCP profile to the desired services.	<pre>set service &lt;Name&gt; - tcpProfileName &lt; string&gt;; show service &lt;name&gt;</pre>	<pre>set service SVC-S1 - tcpProfileName NS1- SERVERS-JUMBO; set service SVC-S2 - tcpProfileName NS1- SERVERS-JUMBO</pre>
Save the configuration	<pre>save ns config; show ns config</pre>	

**Use Case: Coexistence of Jumbo and Non-Jumbo flows on Same Set of Interfaces**

Consider an example in which load balancing virtual servers LBVS1 and LBVS2 are configured on NetScaler instance NS1. LBVS1 is used to load balance HTTP traffic across servers S1 and S2, and global is used to load balance traffic across servers S3 and S4.

CL1 is on VLAN 10, S1 and S2 are on VLAN20, CL2 is on VLAN 30, and S3 and S4 are on VLAN 40. VLAN 10 and VLAN 20 support jumbo frames, and VLAN 30 and VLAN 40 support only non-jumbo frames.

In other words, the connection between CL1 and NS1, and the connection between NS1 and server S1 or S2 support jumbo frames. The connection between CL2 and NS1, and the connection between NS1 and server S3 or S4 support only non-jumbo frames.

Interface 10/1 of NS1 receives or sends traffic from or to clients. Interface 10/2 of NS1 receives or sends traffic from or to the servers.

Interface 10/1 is bound to both VLAN 10 and VLAN 20 as a tagged interface. Interface 10/2 is bound to both VLAN 30 and VLAN 40 as a tagged interface.

For supporting jumbo frames, the MTU is set to 9216 for interfaces 10/1 and 10/2.

On NS1, the MTU is set to 9000 for VLAN 10 and VLAN 30 for supporting jumbo frames. The MTU is set to the default value of 1500 for VLAN 20 and VLAN 40 for supporting only non-jumbo frames.

The effective MTU on an ADC interface for VLAN tagged packets is of the MTU of the interface or the MTU of the VLAN, whichever is lower. For example:

- The MTU of interface 10/1 is 9216. The MTU of VLAN 10 is 9000. On interface 10/1, the MTU of VLAN 10 tagged packets is 9000.
- The MTU of interface 10/2 is 9216. The MTU of VLAN 20 is 9000. On interface 10/2, the MTU of VLAN 20 tagged packets is 9000.
- The MTU of interface 10/1 is 9216. The MTU of VLAN 30 is 1500. On interface 10/1, the MTU of VLAN 30 tagged packets is 1500.
- The MTU of interface 10/2 is 9216. The MTU of VLAN 40 is 1500. On interface 10/2, the MTU of VLAN 40 tagged packets is 9000.

CL1, S1, S2, and all network devices between CL1 and S1 or S2 are configured for jumbo frames.

Since HTTP traffic is based on TCP, MSSs are set accordingly at each end point for supporting jumbo frames.

- For the connection between CL1 and virtual server LBVS-1 of NS1, the MSS on NS1 is set in a TCP profile, which is then bound to LBVS1.
- For the connection between a SNIP address of NS1 and S1, the MSS on NS1 is set in a TCP profile, which is then bound to the service (SVC-S1) representing S1 on NS1.

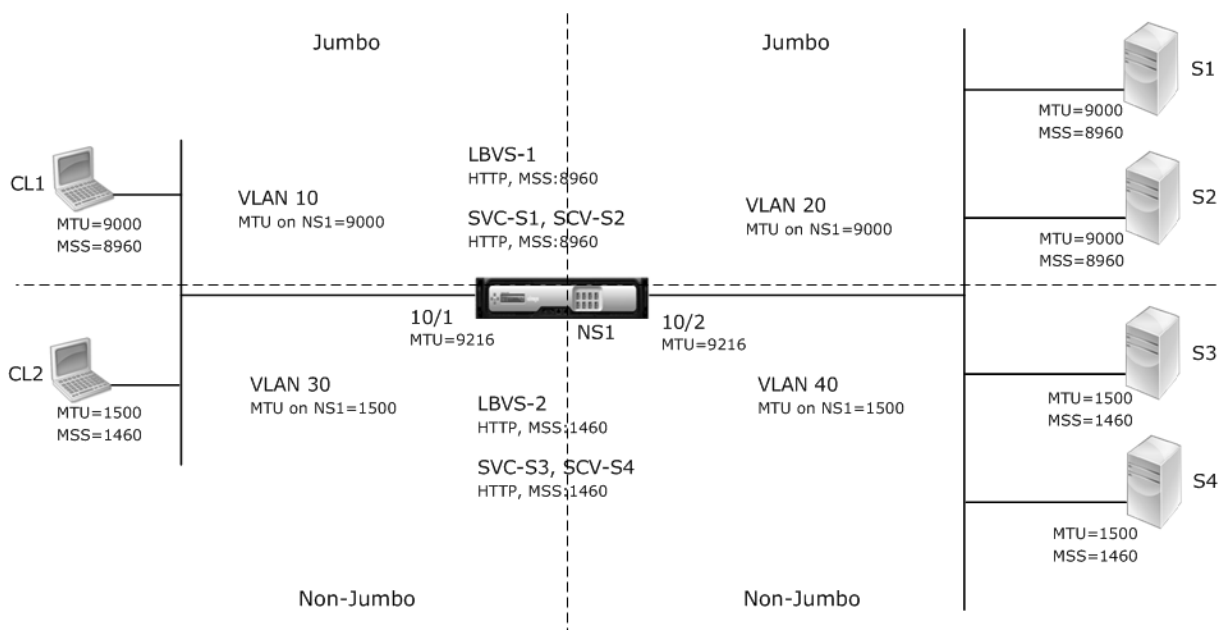

The following table lists the settings used in this example.

Entity	Name	Details
IP address of clients	CL1	192.0.2.10
	CL2	
IP address of servers	S1	198.51.100.19
	S2	
	S3	
	S4	
SNIP addresses on NS1		198.51.100.18; 198.51.101.18
MTU specified for interfaces and VLANs on NS1	10/1	9216
	10/2	
VLAN 10	9000	
VLAN 20	9000	
VLAN 30	9000	
VLAN 40	1500	
Default TCP profile	nstcp_default_profile	MSS: 1460
Custom TCP profile	ALL-JUMBO	MSS: 8960

Entity	Name	Details
Services on NS1 representing servers	SVC-S1	IP address: 198.51.100.19; Protocol: HTTP; Port: 80; TCP profile: ALL-JUMBO (MSS: 8960)
	SVC-S2	
	SVC-S3	
	SVC-S4	
Load balancing virtual servers on NS1	LBVS-1	IP address = 203.0.113.15; Protocol: HTTP; Port: 80. Bound services: SVC-S1, SVC-S2; TCP profile: ALL-JUMBO (MSS: 8960)
	LBVS-2	

---

Following is the traffic flow of CL1's request to S1:

1. Client CL1 creates a 20000-byte HTTP request to send to virtual server LBVS-1 of NS1.
2. CL1 opens a connection to LBVS-1 of NS1. CL1 and NS1 exchange their TCP MSS values while establishing the connection.
3. Because NS1's MSS value is smaller than the HTTP request, CL1 segments the request data into multiples of NS1's MSS and sends these segments in IP packets tagged as VLAN 10 to NS1.
  - Size of the first two packets = [IP Header + TCP Header + (TCP segment=NS1 MSS)] = [20 + 20 + 8960] = 9000
  - Size of the last packet = [IP Header + TCP Header + (remaining TCP segment)] = [20 + 20 + 2080] = 2120
4. NS1 receives these packets at interface 10/1. NS1 accepts these packets because the size of these packets is equal to or less than the effective MTU (9000) of interface 10/1 for VLAN 10 tagged packets.
5. From the IP packets, NS1 assembles all the TCP segments to form the 20000-byte HTTP request. NS1 processes this request.
6. LBVS-1's load balancing algorithm selects server S1, and NS1 opens a connection between one of its SNIP addresses and S1. NS1 and CL1 exchange their respective TCP MSS values while establishing the connection.
7. NS1 segments the request data into multiples of S1's MSS and sends these segments in IP packets tagged as VLAN 20 to S1.
  - Size of the first two packets = [IP Header + TCP Header + (TCP payload=S1 MSS)] = [20 + 20

$$+ 8960] = 9000$$

- Size of the last packet = [IP Header + TCP Header + (remaining TCP segment)] = [20 + 20 + 2080] = 2120

Following is the traffic flow of S1's response to CL1:

1. Server S1 creates a 30000-byte HTTP response to send to the SNIP address of NS1.
2. S1 segments the response data into multiples of NS1's MSS and sends these segments in IP packets tagged as VLAN 20 to NS1. These IP packets are sourced from S1's IP address and destined to the SNIP address of NS1.
  - Size of first three packet = [IP Header + TCP Header + (TCP segment=NS1's MSS size)] = [20 + 20 + 8960] = 9000
  - Size of the last packet = [IP Header + TCP Header + (remaining TCP segment)] = [20 + 20 + 3120] = 3160
3. NS1 receives the response packets at interface 10/2. NS1 accepts these packets, because their size is equal to or less than the effective MTU value (9000) of interface 10/2 for VLAN 20 tagged packets.
4. From these IP packets, NS1 assembles all the TCP segments to form the 30000-byte HTTP response. NS1 processes this response.
5. NS1 segments the response data into multiples of CL1's MSS and sends these segments in IP packets tagged as VLAN 10, from interface 10/1, to CL1. These IP packets are sourced from LBVS' s IP address and destined to CL1's IP address.
  - Size of first three packet = [IP Header + TCP Header + [(TCP payload=CL1's MSS size)] = [20 + 20 + 8960] = 9000
  - Size of the last packet = [IP Header + TCP Header + (remaining TCP segment)] = [20 + 20 + 3120] = 3160

### Configuration Tasks:

On the SDX Management Service, navigate to **Configuration > System > Interfaces** page. Select the required interface and click **Edit**. Set the MTU value and click **OK**.

### Example:

Set the following MTU values:

- For 10/1 interface as 9216
- For 10/2 interface as 9216

Log on to the NetScaler instance and use the ADC command line interface to complete the remaining configuration steps.

The following table lists the tasks, commands, and examples for creating the required configuration on the NetScaler instances.

Task	Syntax	Example
Create VLANs and set the MTU of the desired VLANs for supporting jumbo frames.	<pre>add vlan &lt;id&gt; -mtu &lt; positive_integer&gt;; show vlan &lt;id&gt;</pre>	<pre>add vlan 10 -mtu 9000 ;add vlan 20 -mtu 9000 ;add vlan 30 -mtu 1500 ;add vlan 40 -mtu 1500</pre>
Bind interfaces to VLANs.	<pre>bind vlan &lt;id&gt; -ifnum &lt;interface_name&gt;;show vlan &lt;id&gt;</pre>	<pre>bind vlan 10 -ifnum 10/1 -tagged;bind vlan 20 -ifnum 10/2 - tagged;bind vlan 30 - ifnum 10/1 -tagged ;bind vlan 40 -ifnum 10/2 -tagged</pre>
Add a SNIP address.	<pre>add ns ip &lt;IPAddress&gt; &lt;netmask&gt; -type SNIP ;show ns ip</pre>	<pre>add ns ip 198.51.100.18 255.255.255.0 -type SNIP;add ns ip 198.51.101.18 255.255.255.0 -type SNIP</pre>
Create services representing HTTP servers.	<pre>add service &lt; serviceName&gt; &lt;ip&gt; HTTP &lt;port&gt;;show service &lt;name&gt;</pre>	<pre>add service SVC-S1 198.51.100.19 http 80 ;add service SVC-S2 198.51.100.20 http 80 ;add service SVC-S3 198.51.101.19 http 80 ;add service SVC-S4 198.51.101.20 http 80</pre>
Create HTTP load balancing virtual servers and bind the services to it	<pre>add lb vserver &lt;name&gt; HTTP &lt;ip&gt; &lt;port&gt;;bind lb vserver &lt; vserverName&gt; &lt; serviceName&gt;;show lb vserver &lt;name&gt;</pre>	<pre>add lb vserver LBVS-1 http 203.0.113.15 80 ;bind lb vserver LBVS -1 SVC-S1;bind lb vserver LBVS-1 SVC-S2</pre>

Task	Syntax	Example
Create a custom TCP profile and set its MSS for supporting jumbo frames.	<code>add tcpProfile &lt;name&gt; -mss &lt;positive_integer&gt;;show tcpProfile &lt;name&gt;</code>	<code>add tcpprofile ALL-JUMBO -mss 8960</code>
Bind the custom TCP profile to the desired load balancing virtual server and services.	<code>set service &lt;Name&gt; -tcpProfileName &lt;string&gt;;show service &lt;name&gt;</code>	<code>set lb vserver LBVS-1 - tcpProfileName ALL-JUMBO;set service SVC-S1 - tcpProfileName ALL-JUMBO;set service SVC-S2 - tcpProfileName ALL-JUMBO</code>
Save the configuration	<code>save ns config; show ns config</code>	

## Configuring SNMP on SDX Appliances

August 1, 2023

You can configure an SNMP agent on the NetScaler SDX appliance to generate asynchronous events, which are called traps. The traps are generated whenever there are abnormal conditions on the SDX appliance. The traps are then sent to a remote device called a *trap listener*, which signals the abnormal condition on the SDX appliance.

In addition to configuring an SNMP trap destination, downloading MIB files, and configuring one or more SNMP managers, you can configure the NetScaler SDX appliance for SNMPv3 queries.

The following figure illustrates a network with an SDX appliance that has SNMP enabled and configured. In the figure, each SNMP network management application uses SNMP to communicate with the SNMP agent on the SDX appliance.

Figure 1. *SDX Appliance Supporting SNMP*

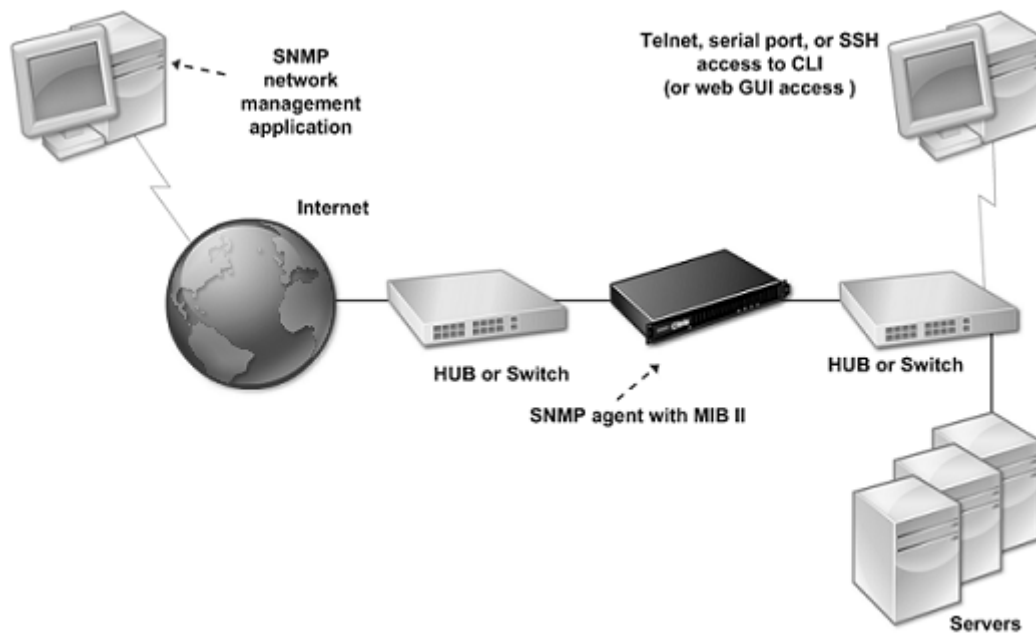

The SNMP agent on the SDX appliance generates traps that are compliant with SNMPv2 only. The supported traps can be viewed in the SDX MIB file. You can download this file from the Downloads page in the SDX user interface.

### To add an SNMP trap destination

1. On the configuration tab, in the navigation pane, expand **System > SNMP**, and then click SNMP Trap Destinations.
2. In the SNMP Trap Destinations pane, click Add.
3. In the Configure SNMP Trap Destination page, specify values for the following parameters:
  - Destination Server—IPv4 address of the trap listener to which to send the SNMP trap messages.
  - Port—UDP port at which the trap listener listens for trap messages. Must match the setting on the trap listener, or the listener drops the messages. Minimum value: 1. Default: 162.
  - Community—Password (string) sent with the trap messages, so that the trap listener can authenticate them. Can include letters, numbers, and hyphen (-), period (.) hash (#), space ( ), at (@), equals (=), colon (:), and underscore (\_) characters.  
Note: Specify the same community string on the trap listener device, or the listener drops the messages. Default: public.
4. Click Add, and then click Close. The SNMP trap destination that you added appears in the SNMP Traps pane.



To modify the values of the parameters of an SNMP trap destination, in the SNMP Trap Destinations pane, select the trap destination that you want to modify, and then click Modify. In the Modify SNMP Trap Destination dialog box, modify the parameters.

To remove an SNMP trap, in the SNMP Trap Destinations pane, select the trap destination that you want to remove, and then click Delete. In the Confirm message box, click to remove the SNMP trap destination.

## Downloading MIB Files

You must download the following file before you start monitoring an SDX appliance.

**SDX-MIB-smiv2.mib.** This file is used by SNMPv2 managers and SNMPv2 trap listeners.

The file includes a NetScaler enterprise MIB that provides SDX-specific events.

### To download MIB files

1. Log on to the Downloads page of the SDX appliance user interface.
2. Under SNMP Files, click SNMP v2 - MIB Object Definitions. You can open the file by using a MIB browser.

## Adding an SNMP Manager Community

Configure SNMP managers on the SDX appliance to query and monitor the appliance and managed devices hosted on the appliance. Also, you must provide the SNMP manager with the required appliance-specific information. For an IPv4 SNMP manager you can specify a host name instead of the manager's IP address. If you do so, you must add a DNS name server that resolves the host name of the SNMP manager to its IP address.

Configure at least one SNMP manager. If you do not configure an SNMP manager, the appliance does not accept or respond to SNMP queries from any IP address on the network. If you configure one or more SNMP managers, the appliance accepts and responds only to SNMP queries from those specific IP addresses.

### To configure an SNMP manager

1. On the Configuration tab, in the navigation pane, expand System, and then expand SNMP.
2. Click Managers.
3. In the details pane, click Add.
4. In the Create SNMP Manager Community page, set the following parameters:

- **SNMP Manager**—IPv4 address of the SNMP manager. Alternatively, instead of an IPv4 address, you can specify a host name that has been assigned to an SNMP manager. If you do so, you must add a DNS name server that resolves the host name of the SNMP manager to its IP address.
  - **Community**—The SNMP community string. Can consist of 1 to 31 characters that include uppercase and lowercase letters, numbers, and the hyphen (-), period (.) pound (#), at (@), equals (=), colon (:), and underscore (\_) characters.
  - Select the **Enable Management Network** check box to specify the SNMP managers by using the netmask.
  - In the **Netmask** field, enter the netmask of the SNMP community.
5. Click Add, and then click Close.

### Configuring the SDX Appliance for SNMPv3 Queries

SNMPv3 is based on the basic structure and architecture of SNMPv1 and SNMPv2. However, SNMPv3 enhances the basic architecture to incorporate administration and security capabilities, such as authentication, access control, data integrity check, data origin verification, message timeliness check, and data confidentiality.

The NetScaler SDX appliance supports the following entities that enable you to implement the security features of SNMPv3:

- SNMP Views
- SNMP Users

These entities function together to implement the SNMPv3 security features. Views are created to allow access to subtrees of the MIB.

### Adding an SNMP Manager

Configure the SDX appliance to allow the appropriate SNMP managers to query it. Also provide the SNMP manager with the required appliance-specific information. For an IPv4 SNMP manager you can specify a host name instead of the manager's IP address. If you do so, you must add a DNS name server that resolves the host name of the SNMP manager to its IP address.

Configure at least one SNMP manager. If you do not configure an SNMP manager, the appliance does not accept or respond to SNMP queries from any IP address on the network. If you configure one or more SNMP managers, the appliance accepts and responds only to SNMP queries from those specific IP addresses.

**To configure an SNMP manager:**

1. Navigate to the **System > Configuration** page.
2. On the Configuration tab, in the navigation pane, expand System, and then expand SNMP.
3. Click Managers.
4. In the details pane, click Add.
5. In the Add SNMP Manager Community dialog box, set the following parameters:
  - **SNMP Manager**—IPv4 address of the SNMP manager. Alternatively, instead of an IPv4 address, you can specify a host name that has been assigned to an SNMP manager. If you do so, you must add a DNS name server that resolves the host name of the SNMP manager to its IP address.
  - **Community**—The SNMP community string. Can consist of 1 to 31 characters that include uppercase and lowercase letters, numbers, and the hyphen (-), period (.) pound (#), at (@), equals (=), colon (:), and underscore (\_) characters.
6. Click Add, and then click Close.

## Configuring an SNMP View

SNMP views restrict user access to specific portions of the MIB. SNMP views are used to implement access control.

### To configure a view

1. On the Configuration tab, in the navigation pane, expand System, and then expand SNMP.
2. Click Views.
3. In the details pane, click Add.
4. In the Add SNMP View dialog box, set the following parameters:
  - **Name**—Name for the SNMPv3 view. Can consist of 1–31 characters that include uppercase and lowercase letters, numbers, and the hyphen (-), period (.) pound (#), at (@), equals (=), colon (:), and underscore (\_) characters. Choose a name that helps identify the SNMPv3 view.
  - **Subtree**—A particular branch (subtree) of the MIB tree, which you want to associate with this SNMPv3 view. Specify the subtree as an SNMP OID.
  - **Type**—Include or exclude the subtree, specified by the subtree parameter, in or from this view. This setting can be useful when you have included a subtree, such as A, in an SNMPv3 view and you want to exclude a specific subtree of A, such as B, from the SNMPv3 view.

## Configuring an SNMP User

After you have created an SNMP view, add SNMP users. SNMP users have access to the MIBs that are required for querying the SNMP managers.

### To configure a user

1. On the Configuration tab, in the navigation pane, expand System, and then expand SNMP.
2. Click Users.
3. In the details pane, click Add.
4. In the Create SNMP User page, set the following parameters:
  - Name—Name for the SNMPv3 user. Can consist of 1–31 characters that include uppercase and lowercase letters, numbers, and the hyphen (-), period (.) pound (#), at (@), equals (=), colon (:), and underscore (\_) characters.
  - Security Level—Security level required for communication between the appliance and the SNMPv3 users. Select from one of the following options:
    - noAuthNoPriv—Require neither authentication nor encryption.
    - authNoPriv—Require authentication but no encryption.
    - authPriv—Require authentication and encryption.
  - Authentication Protocol—Authentication algorithm used by the appliance and the SNMPv3 user for authenticating the communication between them. Specify the same authentication algorithm when you configure the SNMPv3 user in the SNMP manager.
  - Authentication Password—Pass phrase to be used by the authentication algorithm. Can consist of 1–31 characters that include uppercase and lowercase letters, numbers, and the hyphen (-), period (.) pound (#), space ( ), at (@), equals (=), colon (:), and underscore (\_) characters.
  - Privacy Protocol—Encryption algorithm used by the appliance and the SNMPv3 user for encrypting the communication between them. Specify the same encryption algorithm when you configure the SNMPv3 user in the SNMP manager.
  - View Name—Name of the configured SNMPv3 view that you want to bind to this SNMPv3 user. An SNMPv3 user can access the subtrees that are bound to this SNMPv3 view as type INCLUDED, but cannot access the ones that are type EXCLUDED.

## Configuring an SNMP Alarm

The appliance provides a predefined set of condition entities called SNMP alarms. When the condition set for an SNMP alarm is met, the appliance generates SNMP trap messages that are sent to the configured trap listeners. For example, when the deviceAdded alarm is enabled, a trap message is

generated and sent to the trap listener whenever a device (instance) is provisioned on the appliance. You can assign a severity level to an SNMP alarm. When you do so, the corresponding trap messages are assigned that severity level.

Following are the severity levels defined on the appliance, in decreasing order of severity:

- Critical
  - Major
- Minor
- Warning
- Informational (default)

For example, if you set a Warning severity level for the SNMP alarm named deviceAdded, the trap messages generated when a device is added are assigned with the Warning severity level.

You can also configure an SNMP alarm to log the corresponding trap messages generated whenever the condition on that alarm is met.

To modify a predefined SNMP alarm, click **System > SNMP > Alarms**.

## Configure syslog notifications

August 1, 2023

SYSLOG is a standard logging protocol. It has two components: the SYSLOG auditing module, which runs on the NetScaler SDX appliance, and the SYSLOG server, which can run on a remote system. SYSLOG uses UDP for data transfer.

When you run a SYSLOG server, it connects to the SDX appliance. The appliance then starts sending all the log information to the SYSLOG server, and the server can filter the log entries before storing them in a log file. A SYSLOG server can receive log information from more than one SDX appliance, and an SDX appliance can send log information to more than one SYSLOG server.

The log information that a SYSLOG server collects from an SDX appliance is stored in a log file in the form of messages. These messages typically contain the following information:

- The IP address of the SDX appliance that generated the log message
- A time stamp
- The message type
- The log level (Critical, Error, Notice, Warning, Informational, Debug, Alert, or Emergency)

- The message information

You can use this information to analyze the source of the alert and take corrective action if necessary. First configure a syslog server that the appliance sends log information to, and then specify the data and time format for recording the log messages.

### Configure a syslog server

1. Navigate to **System > Notifications > Syslog Servers**.
2. In the details pane, click **Add**.
3. In the **Create Syslog Server** page, specify values for the syslog server parameters. For a description of a parameter, hover the mouse over the corresponding field.
4. Click **Add**, and then click **Close**.

### Configure the syslog parameters

1. Navigate to **System > Notifications > Syslog Servers**.
2. In the details pane, click **Syslog Parameters**.
3. In the **Configure Syslog Parameters** page, specify the date and time format.
4. Click **OK**, and then click **Close**.

## Configuring Mail Notifications

November 3, 2023

Configure an SMTP server to receive an email message each time an alert is raised. First configure an SMTP server, and then configure a mail profile. In the mail profile, use commas to separate the addresses of the recipients.

### To configure an SMTP server

1. Navigate to **System > Notifications > Email**.
2. In the details pane, click the **Email Server** tab, and then click **Add**.
3. In the **Create Email Server** page, specify values for the server parameters.
  - **Server name / IP address:** Enter the server name or IP address of the SMTP mail server.
  - **Port:** Enter the port number. The default value is 25.

- **Authentication:** Select this option to authenticate access to the email server.
- **Secure:** Select this option to create a secure email connection. By default, TLS 1.2 is used to encrypt the email communication.

4. Click **Create**.

### To configure a mail profile

1. Navigate to **System > Notifications > Email**.
2. In the details pane, click the **Email** tab, and then click **Add**.
3. In the **Create Email Distribution List** page, specify values for the parameters. For a description of a parameter, hover the mouse over the corresponding field.
4. Click **Create**.

## Configure SMS notifications

August 1, 2023

Configure a short message service (SMS) server to receive an SMS message each time an alert is raised. First configure an SMS server, and then configure an SMS profile. In the SMS profile, use commas to separate the addresses of the recipients.

### Configure an SMS server

1. Navigate to **System > Notifications > SMS**.
2. In the details pane, click **SMS Server**, and then click **Add**.
3. In the **Create SMS Server** page, specify the values for the SMS server parameters. The values for these parameters are provided by the vendor.
4. Click **Create**, and then click **Close**.

### Configure an SMS profile

1. Navigate to **System > Notifications > SMS**.
2. In the details pane, click **SMS Distribution List**, and then click **Add**.
3. In the **Create SMS Distribution List** page, specify the values for the mail profile parameters. For a description of a parameter, hover the mouse over the corresponding field.
4. Click **Create**, and then click **Close**.

## Monitor and manage the real-time status of entities configured on an SDX appliance

December 12, 2023

The NetScaler SDX appliance can monitor and manage the states of virtual servers, services, service groups, and servers across the virtual appliances hosted on the SDX appliance. You can monitor values, such as the health of a virtual server and the time elapsed since the last state change of a service or service group. This monitoring gives you visibility into the real-time status of the entities and makes management of these entities easy when you have many entities configured on your NetScaler instances.

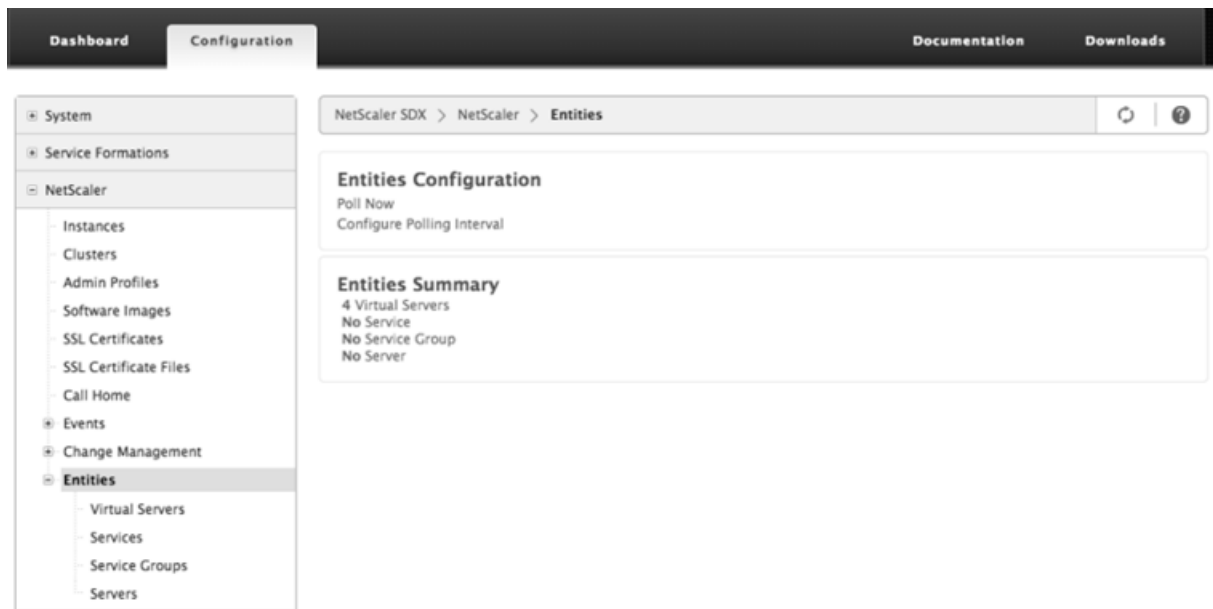

### View the status of virtual servers

You can monitor the real-time values of the state and health of a virtual server. You can also view the attributes of a virtual server, such as name, IP address, and type of virtual server.

- To view the status of a virtual server
  1. On the Configuration tab, in the navigation pane, click **NetScaler > Entities > Virtual Servers**.
  2. In the right pane, under Virtual Servers, view the following statistics:
    - Device Name—Name of the VPX on which the virtual server is configured.
    - Name—Name of the virtual server.
    - Protocol—Service type of the virtual server. For example, HTTP, TCP, and SSL.



- Effective State—Effective state of the virtual server, based on the state of the backup virtual servers. For example, UP, DOWN, or OUT OF SERVICE.
- State—Current state of the virtual server. For example, UP, DOWN, or OUT OF SERVICE.
- Health—Percentage of services that are in the UP state and are bound to the virtual server. The following formula is used to calculate the health percentage: (Number of bound UP services \* 100) / Total bound services
- IP Address —IP address of the virtual server. Clients send connection requests to this IP address.
- Port —Port on which the virtual server listens for client connections.
- Last State Change —Elapsed time (in days, hours, minutes, and seconds) since the last change in the state of the virtual server. That is, the duration of time for which the virtual server has been in the current state. This information is available only for virtual servers configured on NetScaler release 9.0 and later.

Device Name	Name	Protocol	Effective State	State	Health	IP Address	Port	Last State Change
ns2(10.102.163.5)	v1	HTTP	Up	Up	100	10.102.161.13	80	Mon, 10 Mar 2014 17:14:36 GMT
ns2(10.102.163.5)	v2	HTTP	Up	Up	100	10.102.161.14	80	Mon, 10 Mar 2014 17:14:36 GMT
ns2(10.102.163.5)	v3	SSL	Up	Up	100	10.102.161.15	443	Mon, 10 Mar 2014 17:14:36 GMT
ns2(10.102.163.5)	spotted_vip_1	HTTP	Up	Up	100	10.102.161.16	80	Mon, 10 Mar 2014 17:14:36 GMT
ns2(10.102.163.5)	spotted_vip_2	SSL	Up	Up	100	10.102.161.71	443	Mon, 10 Mar 2014 17:14:36 GMT
ns2(10.102.163.5)	spotted_vip_3	HTTP	Up	Up	100	10.102.161.18	80	Mon, 10 Mar 2014 17:14:36 GMT
ns1(10.102.163.4)	v1	HTTP	Up	Up	100	10.102.161.13	80	Mon, 10 Mar 2014 17:14:36 GMT
ns1(10.102.163.4)	v2	HTTP	Up	Up	100	10.102.161.14	80	Mon, 10 Mar 2014 17:14:36 GMT
ns1(10.102.163.4)	v3	SSL	Up	Up	100	10.102.161.15	443	Mon, 10 Mar 2014 17:14:36 GMT
ns1(10.102.163.4)	spotted_vip_1	HTTP	Up	Up	100	10.102.161.16	80	Mon, 10 Mar 2014 17:14:36 GMT
ns1(10.102.163.4)	spotted_vip_2	SSL	Up	Up	100	10.102.161.71	443	Mon, 10 Mar 2014 17:14:36 GMT
ns1(10.102.163.4)	spotted_vip_3	HTTP	Up	Up	100	10.102.161.18	80	Mon, 10 Mar 2014 17:14:36 GMT

- Viewing Services and Service Groups Bound to a Virtual Server

You can monitor the real-time status of the services and service groups bound to a virtual server. This monitoring lets you check the state of the services that might cause the health percentage of a virtual server to become low, so that you can take appropriate action.

To view the services and service groups bound to a virtual server

1. On the Configuration tab, in the left pane, click **NetScaler > Entities > Virtual Servers**.
2. In the details pane, under Virtual Servers, click the name of the virtual server for which you want to display the bound services and service groups, and under Actions, click Bound Service Groups or Bound Services Groups. Alternatively, right-click the name of the virtual server, and then click Bound Services or Bound Services Groups.

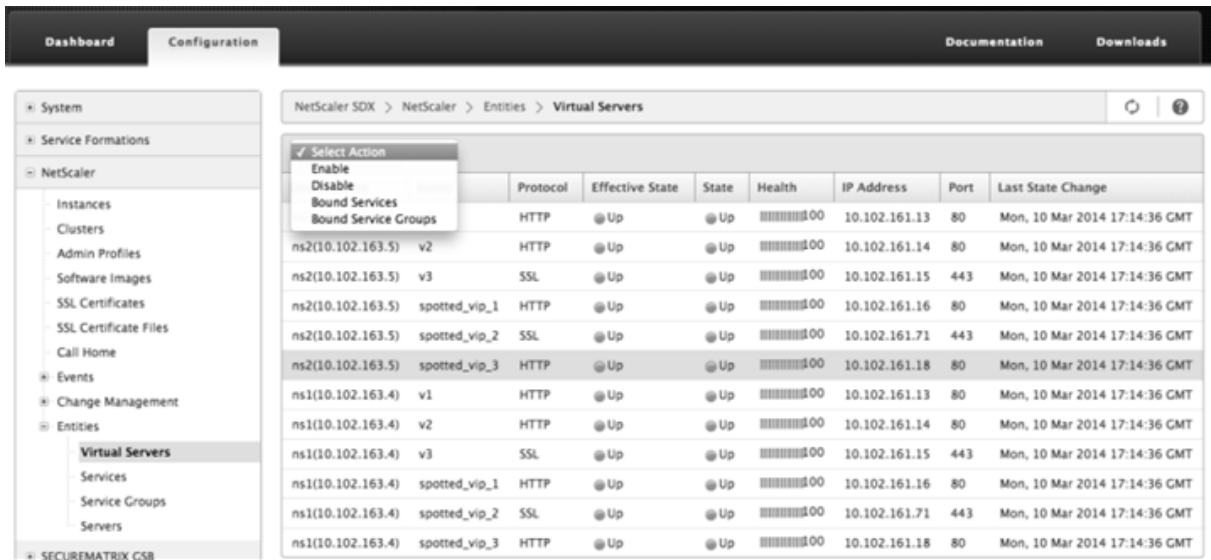

## View the status of services

You can monitor the real-time values of the state of a service and the duration for which the service has been in the current state.

To view the status of virtual servers

1. On the Configuration tab, in the navigation pane, click **NetScaler > Entities > Service**.
  2. In the details pane, under Services, view the following statistics:
    - Device Name —Name of the device on which the service is configured.
    - Name —Name of the service.
    - Protocol —Service type, which determines the behavior of the service. For example, HTTP, TCP, UDP, or SSL.
    - State —Current state of the service. For example, UP, DOWN, or OUT OF SERVICE.
    - IP Address —IP address of the service.
    - Port —Port on which the service listens.
    - Last State Change —Elapsed time (in days, hours, minutes, and seconds) since the last change in the state of the service. That is, the duration of time for which the service has been in the current state.
- Viewing the Virtual Servers to which a Service is Bound

You can view the virtual servers to which a service is bound and monitor the real-time status of the virtual servers.

To view the virtual servers to which a service is bound

1. On the Configuration tab, in the navigation pane, click **NetScaler > Entities > Service**.

2. In the details pane, under Services, click the name of the service for which you want to view the bound virtual servers. Then from the Action menu, select Bound Virtual Servers. Alternatively, right-click the service, and then click Bound Virtual Servers.

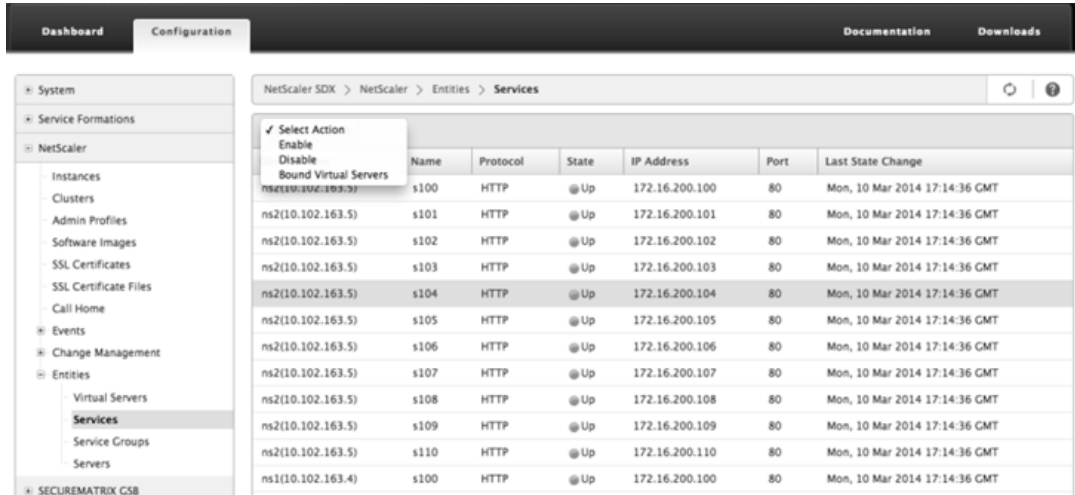

## View the status of service groups

You can monitor the real-time state of a service group member from the SDX interface.

To view the status of service groups

1. On the Configuration tab, in the navigation pane, click **NetScaler > Entities > Service Groups**.
  2. In the details pane, under Service Groups, view the following statistics:
    - Device Name—Name of the device on which the service group is configured.
    - Name—Name of the service group.
    - IP Address—IP address of each service that is a member of the service group.
    - Port—Ports on which the service group members listen.
    - Protocol—Service type, which determines the behavior of the service group. For example, HTTP, TCP, UDP, or SSL.
    - Effective State—Effective state of the virtual server group, based on the state of the backup virtual servers. For example, UP, DOWN, or OUT OF SERVICE
    - State—Effective state of the service group, which is based on the state of the member of the service group. For example, UP, DOWN, or OUT OF SERVICE.
    - Last State Change—Elapsed time (in days, hours, minutes, and seconds) since the last change in the state of the service group member. That is, the duration of time for which the service group member has been in the current state. This information is available only for service group members configured on NetScaler release 9.0 and later.
- Viewing the Virtual Servers to which a Service is Bound

You can view the virtual servers to which a service is bound and monitor the real-time status of the virtual servers.

To view the virtual servers to which the service is bound

1. On the Configuration tab, in the left pane, click **NetScaler > Entities > Servers**.
2. In the right pane, under Servers, select the server from the list, and under the Actions menu, click Bound Virtual Services. Alternately, right-click the service and click Bound Virtual Servers.

### View the status of servers

You can monitor and manage the states of servers across the NetScaler instances. This monitoring gives you visibility into the real-time status of the servers and makes management of these servers easy when you have many servers.

To view the status of servers

1. On the Configuration tab, in the navigation pane, click **NetScaler > Entities > Servers**.
2. In the details pane, under Servers, view the following statistics:
  - Device Name: Specifies the name of the device on which the server is configured.
  - Name: Specifies the name of the server.
  - IP Address: Specifies the IP address of the server. Clients send connection requests to this IP address.
  - State: Specifies the current state of the server. For example, UP, DOWN, and OUT OF SERVICE.
  - Last State Change: Specifies the time elapsed (in days, hours, minutes, and seconds) since the last change in the state of the server. That is, the duration of time for which the server is in the current state.

The screenshot shows the NetScaler SDX Configuration page for Servers. The left pane shows the navigation tree with 'Servers' selected under 'Entities'. The right pane displays a table of servers with columns for Name, IP Address, State, and Last State Change. A context menu is open over the first row, showing options: Select Action, Enable, and Disable.

Name	IP Address	State	Last State Change
ns2(10.102.163.5)	172.16.200.100	Enabled	Mon, 10 Mar 2014 17:14:36 GMT
ns2(10.102.163.5)	172.16.200.101	Enabled	Mon, 10 Mar 2014 17:14:36 GMT
ns2(10.102.163.5)	172.16.200.102	Enabled	Mon, 10 Mar 2014 17:14:36 GMT
ns2(10.102.163.5)	172.16.200.103	Enabled	Mon, 10 Mar 2014 17:14:36 GMT
ns2(10.102.163.5)	172.16.200.104	Enabled	Mon, 10 Mar 2014 17:14:36 GMT
ns2(10.102.163.5)	172.16.200.105	Enabled	Mon, 10 Mar 2014 17:14:36 GMT
ns2(10.102.163.5)	172.16.200.106	Enabled	Mon, 10 Mar 2014 17:14:36 GMT
ns2(10.102.163.5)	172.16.200.107	Enabled	Mon, 10 Mar 2014 17:14:36 GMT
ns2(10.102.163.5)	172.16.200.108	Enabled	Mon, 10 Mar 2014 17:14:36 GMT
ns2(10.102.163.5)	172.16.200.109	Enabled	Mon, 10 Mar 2014 17:14:36 GMT
ns2(10.102.163.5)	172.16.200.110	Enabled	Mon, 10 Mar 2014 17:14:36 GMT
ns1(10.102.163.4)	172.16.200.100	Enabled	Mon, 10 Mar 2014 17:14:36 GMT

## Configure the polling interval

You can set the time interval for which you want the SDX appliance to poll the real-time values of the virtual servers, services, service groups, and servers. By default, the appliance polls the values every 30 minutes.

- To configure the polling interval for virtual servers, services, service groups, and Servers.
  1. On the Configuration tab, click **NetScaler > Entities**, and in the right pane, click Configure Polling Interval.
  2. In the Configure Polling Interval dialog box, type the number of minutes you want to set as the time interval for which SDX must poll the entity value. Minimum value of the polling interval is 30 minutes. Click OK.

## Monitoring and Managing Events Generated on NetScaler instances

December 14, 2023

Use the Events feature to monitor and manage the events generated on the NetScaler instances. The Management Service identifies events in real time, helping you address issues immediately and keeps the NetScaler instances running effectively. You can also configure event rules to filter the events generated and get notified to take actions on the filtered list of events.

### Viewing All Events

You can view all the events generated on the NetScaler instances provisioned on the NetScaler SDX appliance. You can view the details such as severity, category, date, source, and message for each of the events.

To view the events, navigate to **Configuration > NetScaler > Events > All Events**.

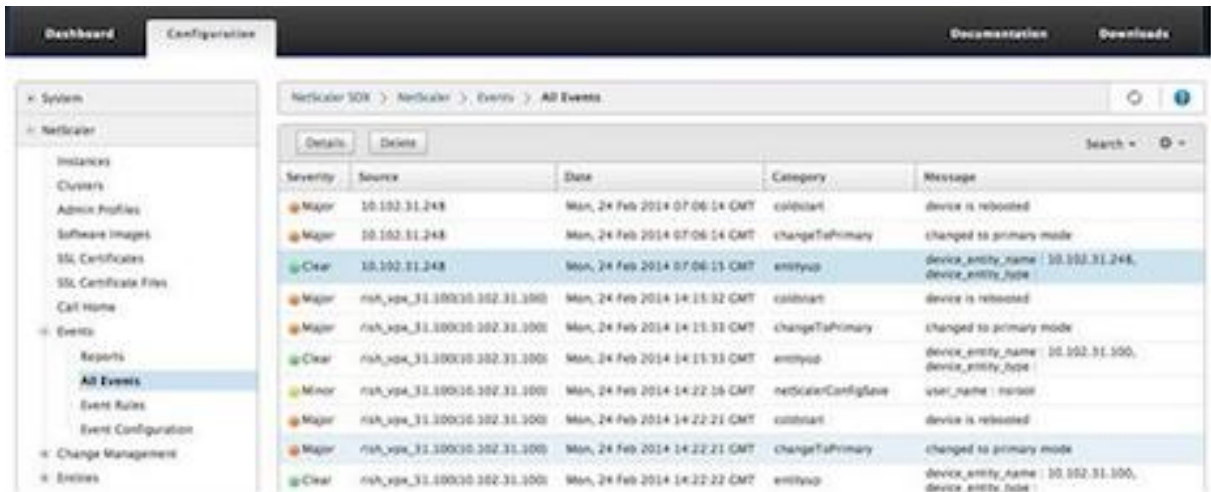

You can view the event history and entity details by selecting the event and clicking the **Details** button. You can also search for a particular event or delete it from this page.

Note: After you delete the events, you will not be able to recover them.

- Viewing Reports

The Reports page displays the events summary in a graphical format. Your view of the reports can be based on various time scales. By default the time scale is Day.

To display the reports, navigate to **Configuration > NetScaler > Events > Reports**. Following are the graphical reports supported on the Management Service

- **Events**

The Events report is a pie chart representation of the number of events, segmented, and color coded based on their severity.



To view the details of the events of a particular severity, click that segment of the pie chart, you can view the following details:

- \* Source: System name, host name, or the IP address on which the event was generated.
- \* Date: Date and time when the alarm was generated.
- \* Category: Event category (for example, `entityup`).
- \* Message: Description of the event.

**- Top 10 NetScaler instances by All Events**

This report is a bar chart that displays the top 10 NetScaler instances according to the number of events for the selected time scale.

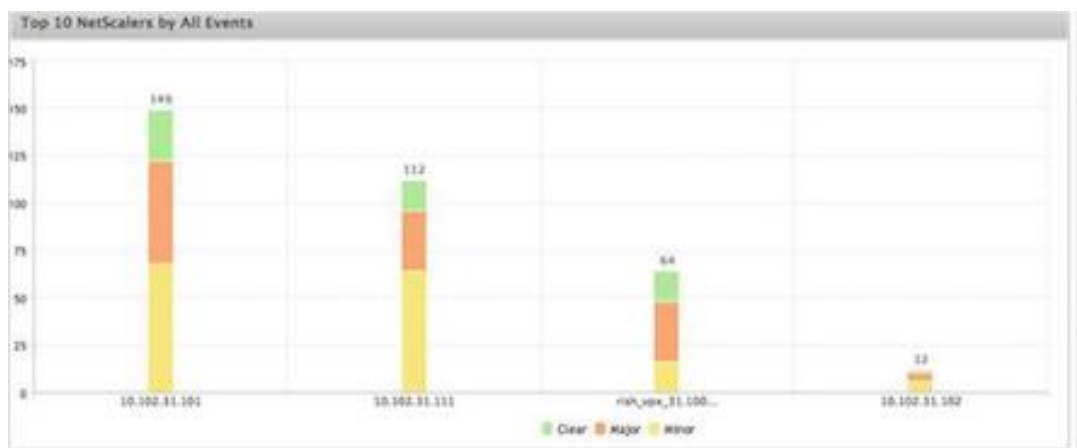

**- Top 10 NetScaler instances by Entity State Change Events**

This report is a bar chart that displays the top 10 NetScaler instances according to the number of entity state changes for the selected time scale. The entity state changes reflect entity up, entity down, or out of service events.

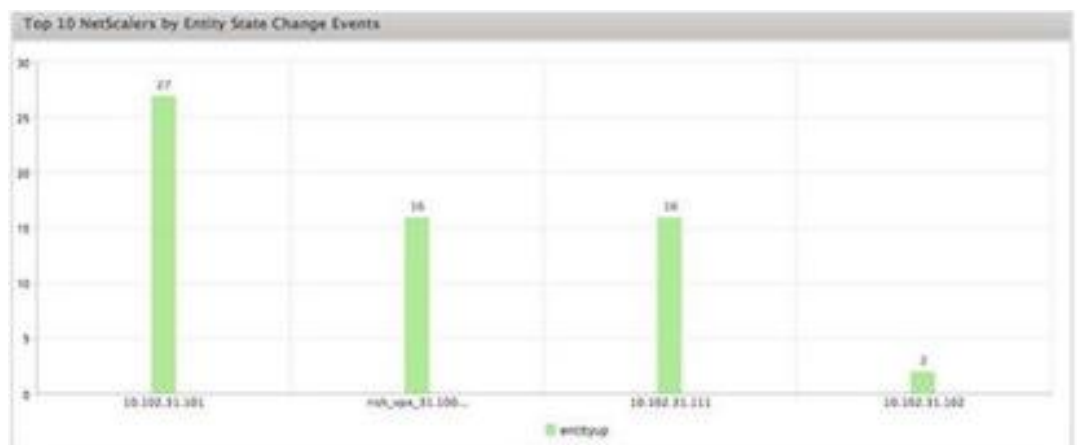

**- Top 10 NetScaler instances by Threshold Violation Events**

This report is a bar chart that displays the top 10 NetScaler instances according to the number of threshold violation events for the selected time scale. The threshold violation events reflect the following events:

- \* cpuUtilization
- \* memoryUtilization
- \* diskUsageHigh
- \* temperatureHigh
- \* voltageLow
- \* voltageHigh
- \* fanSpeedLow
- \* temperatureCpuHigh
- \* interfaceThroughputLow
- \* interfaceBWUseHigh
- \* aggregateBWUseHigh

– **Top 10 NetScaler instances by Hardware Failure Events**

This report is a bar chart that displays the top 10 NetScaler instances according to the number of hardware failure events for the selected time scale. The hardware failure events reflect the following events:

- \* hardDiskDriveErrors
- \* compactFlashErrors
- \* powerSupplyFailed
- \* “sslCardFailed”

– **Top 10 NetScaler instances by Configuration Change Events**

This report is a bar chart that reflects the top 10 NetScaler instances according to the number of configuration change events for the selected time scale. You can click the chart to drill down and view the user based configuration changes for an instance. You can further view the authorization and execution status details by clicking this chart.

– **<Top 10 NetScaler instances by Authentication Failure Events**

This report is a bar chart that displays the top 10 NetScaler instances according to the number of authentication failure events for the selected time scale. You can click the chart to drill down and view the user based authentication failures for an instance.



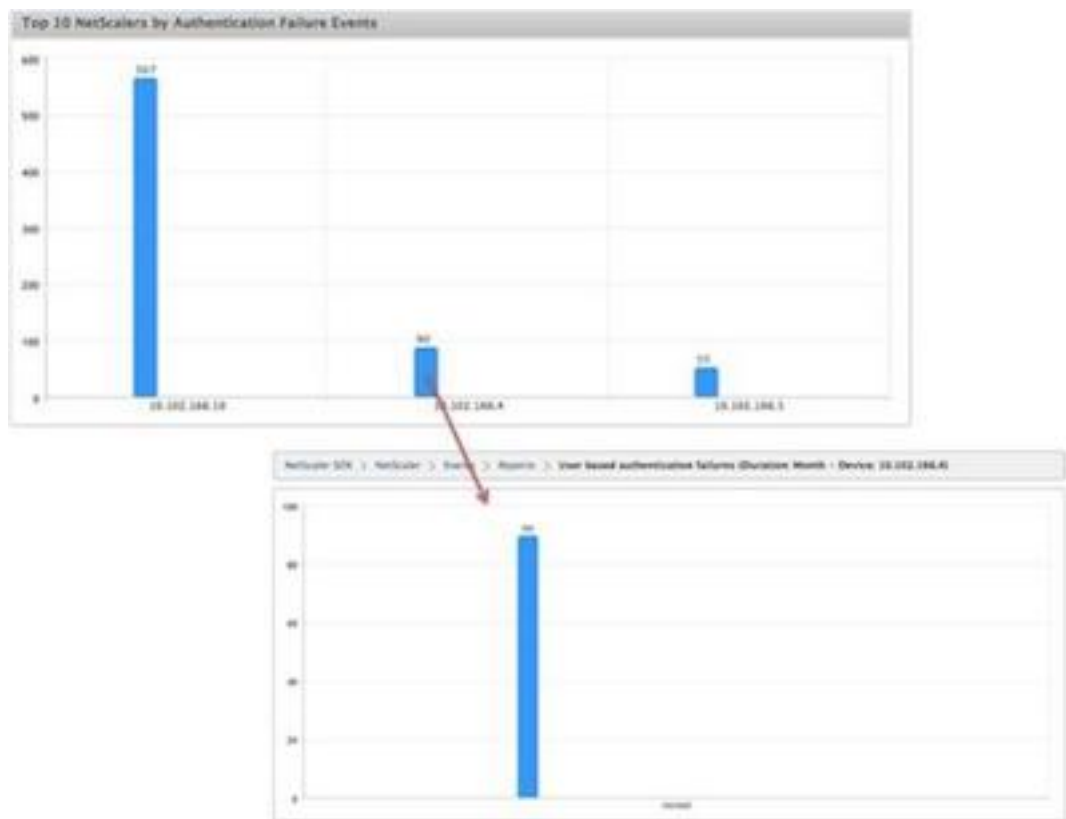

- **Configuring Event Rules**

You can filter a set of events by configuring rules with specific conditions and assigning actions to the rules. When the events generated meet the filter criteria in the rule, the action associated with the rule is performed. The conditions for which you can create filters are: severity, devices, failure objects, and category.

You can assign the following actions to the events:

- **Send e-mail Action** Sends an email for the events that match the filter criteria.
- **Send SMS Action** Sends a Short Message Service(SMS) for the events that match the filter criteria.

To add event rules

1. Navigate to **Configuration > NetScaler > Events > Event Rules**, and click Add.
2. On the Rule page set the following parameters:
  - Name—Name of the event rule.
  - Enabled—Enable the event rule.
  - Severity—Severity of the events for which you want to add the event rule.
  - Devices—IP addresses of the NetScaler instances for which you want to define an event rule.

- Category—Category or categories of the events generated by the NetScaler instances.
- Failure Objects—Entity instances or counters for which an event has been generated.

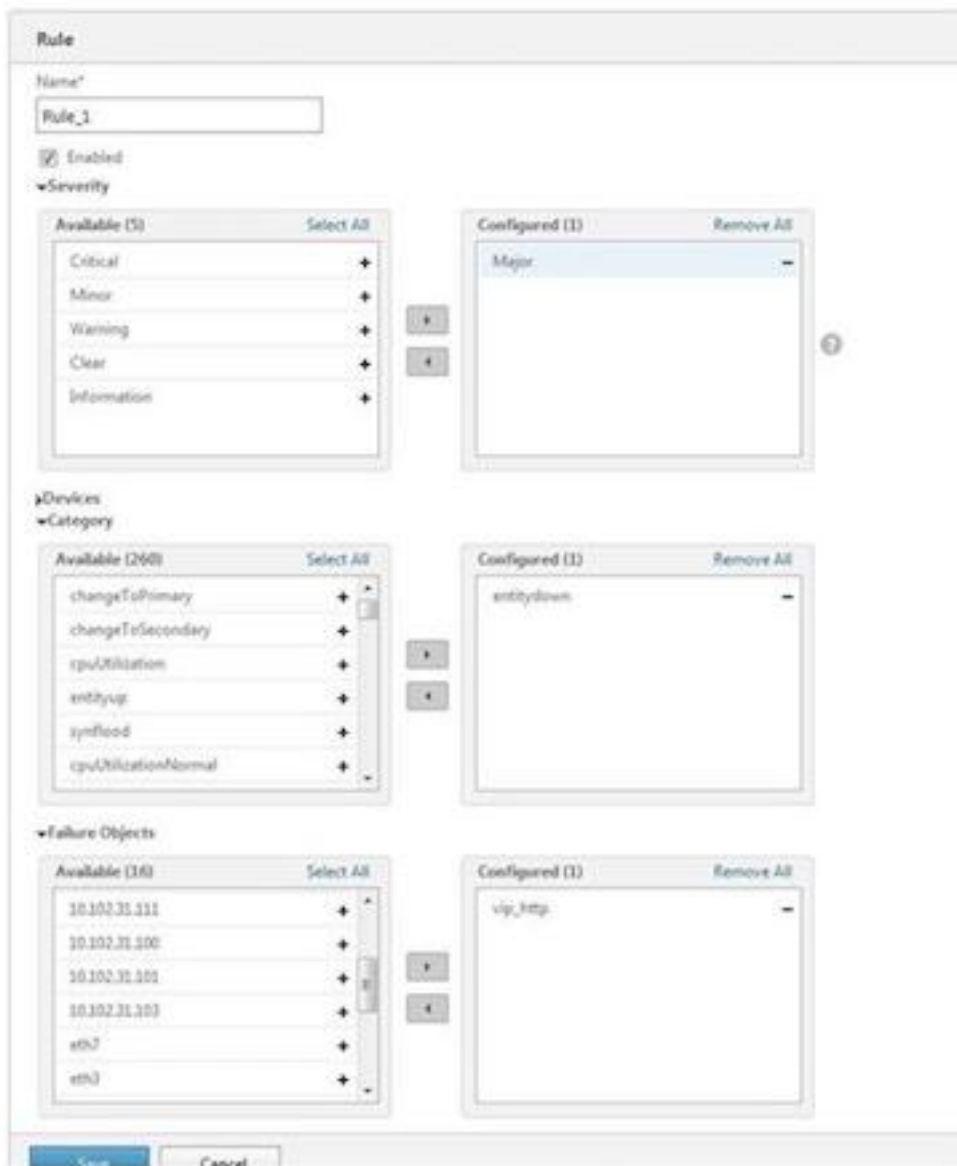

Note: This list can contain counter names for all threshold-related events, entity names for all entity-related events, and certificate names for certificate-related events.

3. Click Save.
4. Under Rule Actions, you can assign the notification actions for the event.
  - a) Mail Profile—Mail server and mail profile details. An email is triggered when the events meet the defined filter criteria.
  - b) SMS Profile—SMS server and SMS profile details. An SMS is triggered when the events meet the defined filter criteria.

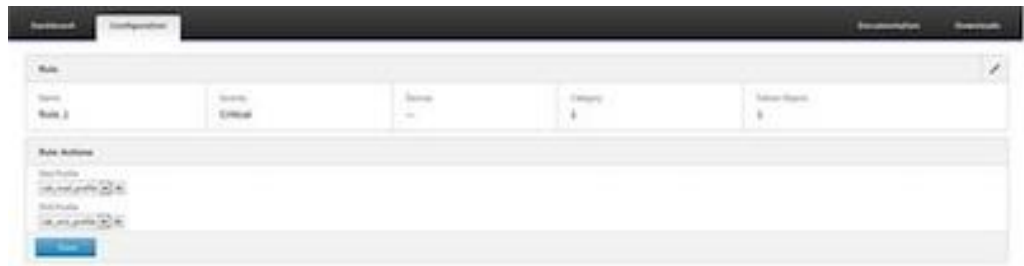

5. Click Done.

- **Configuring Events**

You can assign severity levels to events that are generated for the NetScaler instances on the SDX appliance. You can define the following types of severity levels: Critical, Major, Minor, Warning, Clear, and Information. You can also suppress the events for a specific time.

To configure severity:

1. Navigate to **Configuration > NetScaler > Events > Event Configuration**, select the event from the list, and then click Configure Severity.

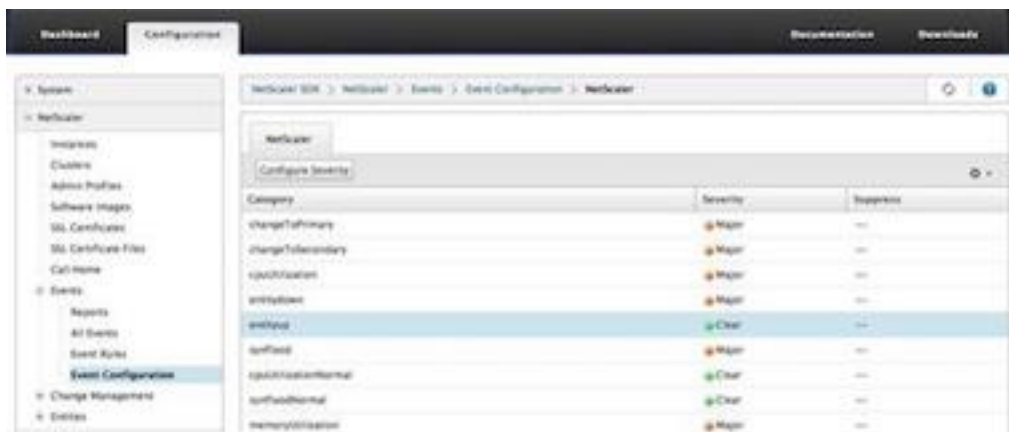

2. On the Configure Events Configuration page, select the required severity level from the drop-down list.
3. Alternatively, you can suppress the events by selecting the Suppress check box. You can also specify the NetScaler instances for which you want to suppress this event by using the Advanced option.

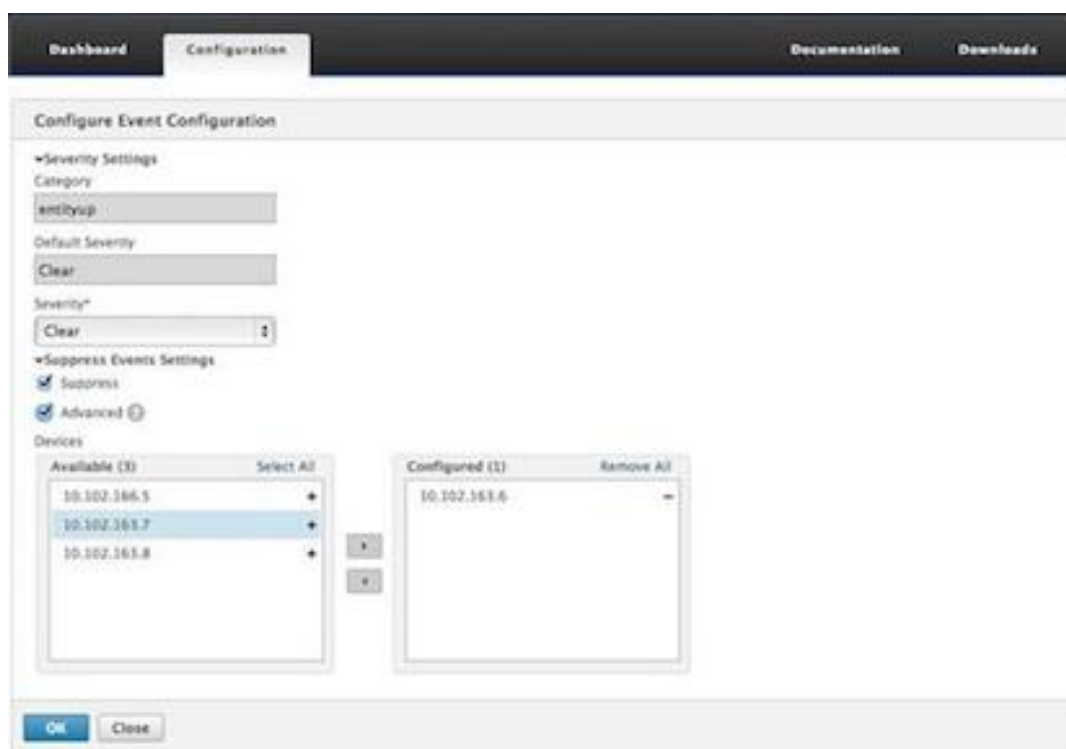

4. Click OK.

## Call Home support for NetScaler instances on an SDX appliance

December 12, 2023

The Call Home feature monitors your NetScaler instances for common error conditions. You can now configure, enable, or disable the Call Home feature on NetScaler instances from the Management Service user interface.

**Note:** The NetScaler instance must be registered with the Citrix technical support server before Call Home can upload the system data to the server when predefined error conditions occur on the appliance. Enabling the Call Home feature on the NetScaler instance initiates the registration process.

- Enabling and Disabling Call Home on a NetScaler instance

You can enable the Call Home feature on a NetScaler instance from the Management Service. When you enable the Call Home feature, the Call Home process registers the NetScaler instance with the Citrix technical support server. The registration takes some time to complete. During that time, the Management Service displays the progress of registration.

To enable the Call Home feature, navigate to **Configuration > NetScaler > Call Home**, select the NetScaler instance, and click the Enable button. In the confirmation page, click Yes.

To disable the Call Home feature, navigate to **Configuration > NetScaler > Call Home**, select the NetScaler instance, and click the Disable button. On the confirmation page, click Yes.

If you enable Call Home, you can configure the following options:

1. (Optional) Specify the administrator’s email address. The Call Home process sends the email address to the Support server, where it is stored for future correspondence regarding Call Home.
  2. (Optional) Enable Call Home proxy mode. Call Home can upload your NetScaler instance’s data to the Citrix TaaS server through a proxy server. To use this feature, enable it on your NetScaler instance and specify the IP address and port number of an HTTP proxy server. All traffic from the proxy server to the TaaS servers (over the Internet) is over SSL and encrypted, so data security and privacy are not compromised.
- To configure Call Home on the NetScaler instance from the Management Service

You can configure the Call Home feature on a single instance or on multiple instances at the same time.

To configure the Call Home feature on a single NetScaler instance, navigate to **Configuration > NetScaler > Call Home**, select the NetScaler instance, and click Configure button. In the Configure Call Home page, click OK.

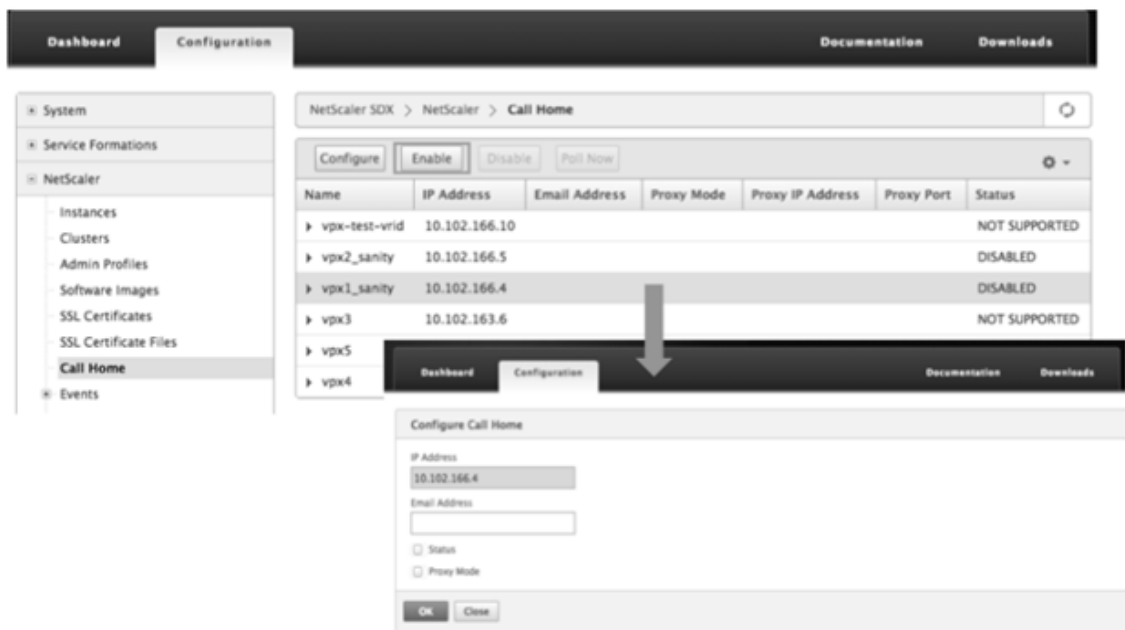

To configure the Call Home feature on multiple NetScaler instances, navigate to **Configuration > NetScaler**. In the right pane, click Call Home. On the Configure Call Home page, select the NetScaler instances from the Available Instances section, specify other details, and click OK.

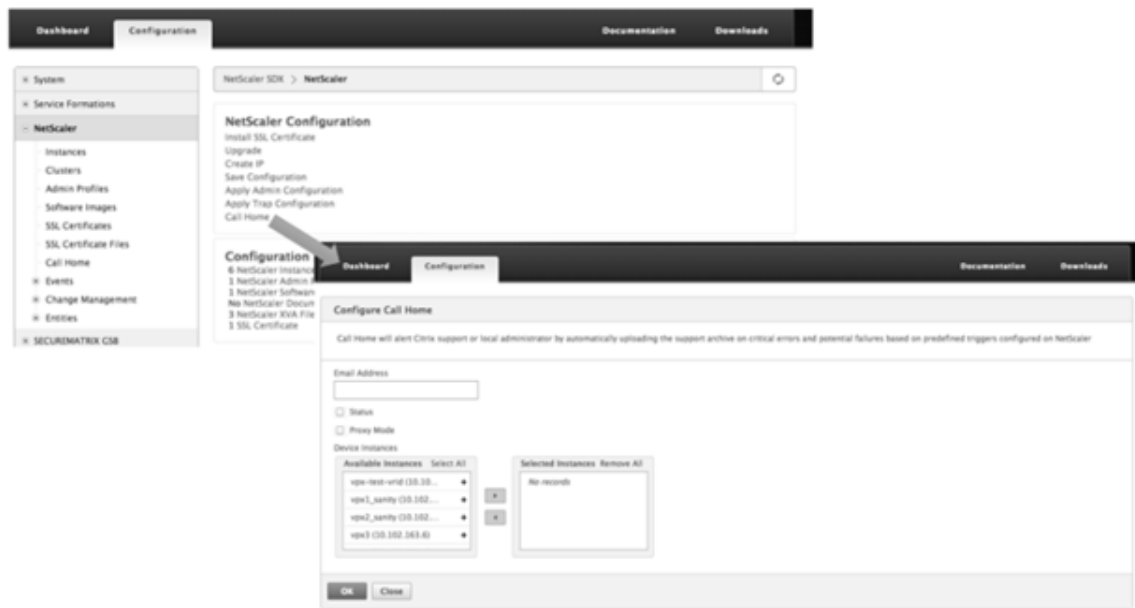

- Polling the NetScaler instances

To poll the Call Home feature from all NetScaler instances and view the current status, navigate to **Configuration > NetScaler > Call Home**, and click **Poll Now**. On the confirmation page, click **Yes**.

## System health monitoring

August 1, 2023

System health monitoring detects errors in the monitored components, so that you can take corrective action to avoid a failure. The following components are monitored on a NetScaler SDX appliance:

- Hardware and software resources
- Physical and virtual disks
- <Hardware sensors, such as fan, temperature, voltage, and power supply sensors
- Interfaces

In the **Monitoring** tab, click **System Health**. A summary of all the components is displayed. To view details of the monitored components, expand **System Health**, and then click the component that you want to monitor.

- Monitoring the Resources on the SDX Appliance

You can monitor the hardware and software components on the SDX appliance and take corrective action if necessary. To view the components monitored, in the Monitoring tab, expand

System Health, and then click Resources. Details are displayed for hardware and software resources. For all hardware components, current and expected values are displayed. For software components, except the BMC firmware version, current and expected values are displayed as not applicable (NA).

- **Name:** Name of the component, such as CPU, memory, or BMC firmware version.
- **Status:** State (condition) of the component. For Hardware and for BMC Firmware Version, ERROR indicates a deviation from the expected value. For calls to Citrix Hypervisor, ERROR indicates that the Management Service is unable to communicate with Citrix Hypervisor by using an API, HTTP, PING, or SSH call. For the Health Monitor plug-in, ERROR indicates that the plug-in is not installed on the Citrix Hypervisor.
- **Current Value:** Current value of the component. In normal conditions, the current value is the same as the expected value.
- **Expected Value:** Expected value for the component. Does not apply to software calls to Citrix Hypervisor.

## Monitor the storage resources on the SDX appliance

You can monitor the disks on the SDX appliance and take corrective action if necessary. To view the components monitored, in the **Monitoring** tab, expand **System Health**, and then click **Storage**. Details are displayed for physical disks and for virtual disks or partitions created from physical disks.

For disks (Disk), the following details are displayed:

- **Name** The name of the physical disk.
- **Size:** Size of the disk, in GB.
- **Utilized:** Amount of data on the disk, in GB.
- **Transactions/s:** Number of blocks being read or written per second. This number is read from the `iostat` output.
- **Blocks Read/s:** Number of blocks being read per second. You can use this value to measure the rate of output from the disk.
- **Blocks Written/s:** Number of blocks being written per second. You can use this value to measure the rate of input to the disk.
- **Total Blocks Read:** Number of blocks read since the appliance was last started.
- **Total Blocks Written:** Number of blocks written since the appliance was last started.

For virtual disks or partitions (Storage Repository), the following details are displayed:

- **Drive Bay:** Number of the drive in the drive bay. You can sort the data on this parameter.
- **Status:** State (condition) of the drive in the drive bay. Possible values:

- **GOOD:** The drive is in a good state and is ready for use.
  - **FAIL:** The drive has failed and must be replaced.
  - **MISSING:** A drive is not detected in the drive bay.
  - **UNKNOWN:** A new unformatted drive exists in the drive bay.
- **Name:** System defined name of the storage depository.
  - **Size:** Size of the storage repository, in GB.
  - **Utilized:** Amount of data in the storage repository, in GB.

## Monitor the hardware Sensors on the SDX appliance

You can monitor the hardware components on the SDX appliance and take corrective action if necessary. In the **Monitoring** tab, expand **System Health**, and then click **Hardware Sensors**. The monitoring function displays details about the speed of different fans, the temperature and voltage of different components, and the status of the power supply.

For fan speed, the following details are displayed:

- **Name:** Name of the fan.
- **Status:** State (condition) of the fan. ERROR indicates a deviation from the expected value. NA indicates that the fan is not present.
- **Current Value (RPM):** Current rotations per minute.

Temperature information includes the following details:

- **Name:** Name of the component, such as CPU or memory module (for example, P1-DIMM1A.)
- **Status:** State (condition) of the component. ERROR indicates that the current value is out of range.
- **Current Value (Degree C):** Current temperature, in degrees, of the component.

Voltage information includes the following details:

- **Name:** Name of the component, such as CPU core.
- **Status:** State (condition) of the component. ERROR indicates that the current value is out of range.
- **Current Value (Volts):** Current voltages present on the component.

Information about the power supply includes the following details:

- **Name:** Name of the component.
- **Status:** State (condition) of the component. Possible values:
  - **Error:** Only one power supply is connected or working.
  - **OK:** Both the power supplies are connected and working as expected.



## Monitor the interfaces on the SDX appliance

You can monitor the interfaces on the SDX appliance and take corrective action if necessary. In the **Monitoring** tab, expand **System Health**, and then click **Interfaces**. The monitoring function details the following information about each interface:

- **Interface:** Interface number on the SDX appliance.
- **Status:** State of the interface. Possible values: UP, DOWN.
- **VFs Assigned/Total:** Number of virtual functions (VFs) assigned to the interface, and the number of virtual functions available on that interface. Different platforms support a different number of VFs.
- **Tx Packets:** Number of packets transmitted since the appliance was last started.
- **Rx Packet:** Number of packets received since the appliance was last started.
- **Tx Bytes:** Number of bytes transmitted since the appliance was last started.
- **Rx Bytes:** Number of bytes received since the appliance was last started.
- **Tx Errors:** Number of errors in transmitting data since the appliance was last started.
- **Rx Errors:** Number of errors in receiving data since the appliance was last started.

## Configuring System Notification Settings

August 1, 2023

You can send notifications to communicate with select groups of users for a number of system-related functions. You can set up a notification server in SDX Management Service to configure email and Short Message Service (SMS) gateway servers to send email and text (SMS) notifications to users.

### Note

After you upgrade to SDX Management Service release 11.1, system notification is enabled for all the event categories, and the notifications are sent to the existing email or SMS profile.

### To configure system notification settings

1. Navigate to **System > Notifications > Settings**, and then click **Change Notification Settings**.
2. In the **Configure System Notification Settings** page, enter the following details:
  - **Category** –Category or categories of the events generated by the SDX Management Service.
  - **Email** –Select an email distribution list from the drop-down menu. You can also create a new email distribution list by clicking on the **+** icon and entering the new email server details in the appropriate fields.

- **SMS (Text Message)** –Select an SMS distribution list from the drop-down menu. You can also create a new SMS distribution list by clicking on the **+** icon and entering the new SMS server details in the appropriate fields.

3. Click **OK**.

## Enable and disable features from the Management Service

August 1, 2023

**Note:**

This feature is available in release 13.1 build 12.x and later.

On a NetScaler SDX appliance, the Management Service polls the NetScaler instances in the background for operations, such as SSL certificates, network functions, and config audit. An option is available to enable or disable this polling depending on your requirement. Disabling this polling improves the performance of the Management Service and the ADC instances.

### To enable or disable features using the GUI

1. Navigate to **System > System Settings**.
2. Click **Configure Features**.
3. Select a feature and click **Enable** or **Disable**.

## Configure the Management Service

August 1, 2023

The Management Service lets you manage client sessions and perform configuration tasks, such as creating and managing user accounts and tweaking backup and pruning policies according to your requirements. You can also restart the Management Service and upgrade the version of the Management Service. You can further create tar files of the Management Service and the Citrix Hypervisor and send it to technical support.

## Manage client sessions

A client session is created when a user logs on to the Management Service. You can view all the client sessions on the appliance in the **Sessions** pane.

In the **Sessions** pane, you can view the following details:

- **User Name:** The user account that is being used for the session.
- **IP Address:** The IP address of the client from which the session has been created.
- **Port:** The port being used for the session.
- **Login Time:** The time at which the current session was created on the SDX appliance.
- **Last Activity Time:** The time at which user activity was last detected in the session.
- **Session Expires In:** Time left for session expiry.

To view client sessions, on the **Configuration** tab, navigate to **System > Sessions**.

To end a client session, in the **Sessions** pane, click the session you want to remove, and then click **End Session**.

You cannot end a session from the client that has initiated that session.

## Configure policies

To keep the size of logged data within manageable limits, the SDX appliance runs backup and data-pruning policies automatically at a specified time.

The prune policy runs at 00:00 A.M every day and specifies the number of days of data to retain on the appliance. By default, the appliance prunes data older than 3 days, but you can specify the number of days of data that you want to keep. Only event logs, audit logs, and task logs are pruned.

The backup policy runs at 00:30 A.M. every day and creates a backup of logs and configuration files. By default, the policy retains three backups, but you can specify the number of backups you want to keep. And, using the backup policy, you can:

- Encrypt the backup files.
- Configure the SDX appliance to transfer the backup files to an external backup server using FTP, SFTP, and SCP.

### To specify the number of days for which logged data is pruned:

1. On the **Configuration** tab, in the navigation pane, click **System**.
2. In the **System** pane, under **Policy Administration**, click **Prune Policy**.
3. In the **Modify Prune Policy** dialog box, in **Data to keep (days)**, specify the number of days of data that the appliance must retain at any given time.
4. Click **OK**.

### To configure the backup policy:

1. On the **Configuration** tab, in the navigation pane, click **System**.
2. In the **System** pane, under **Policy Administration**, click **Backup Policy**.
3. In the **Modify Backup Policy** dialog box, in **Previous Backups** to retain, specify the number of backups that the appliance must retain at any given time.
4. Select **Encrypt Backup File** to encrypt the backup file.
5. Select **External Transfer** and do the following to transfer the backup file to an external backup server:
  - a) In the **Server** field, enter the host name or IP address of the external backup server.
  - b) In the **User Name** and **Password** fields, enter the user name and password to access the external backup server.
  - c) In the **Port** field, enter the port number.
  - d) In the **Transfer Protocol** field, select the protocol you want to use to transfer the backup file to the external backup server.
  - e) In the **Directory Path** field, enter the path of the directory in the external backup server where you want to store the backup files.
6. **Delete file from Management Service after transfer:** Select if you want to delete the backup file from the SDX appliance after you have transferred the backup file to the external backup server.
7. Click **OK**.

### Restart the Management Service

You can restart the Management Service from the **System** pane. Restarting the Management Service does not affect the working of the instances. The instances continue to function during the Management Service restart process.

### To restart the Management Service:

1. On the **Configuration** tab, in the navigation pane, click **System**.
2. In the **System** pane, under **System Administration**, click **Reboot Management Service**.

### Remove Management Service files

You can remove any unneeded Management Service build and documentation files from the SDX appliance.

### To remove a Management Service file:

1. On the **Configuration** tab, in the navigation pane, expand **Management Service**, and then click the file that you want to remove.
2. In the **details** pane, select the file name, and then click **Delete**.

### Generate a tar archive for technical support

You can use the Technical Support option to generate a tar archive of data and statistics for submission to Citrix technical support. This tar can be generated for the Management Service or the Citrix Hypervisor, or for both at the same time. You can then download the file to your local system and send it to Citrix technical support.

In the **Technical Support** pane, you can view the following details.

- **Name:** The name of the tar archive file. The file name indicates whether the tar is for the Management Service or the Citrix Hypervisor server.
- **Last Modified:** The date when this file was last modified.
- **Size:** The size of the tar file.

#### To generate the tar archive for technical support:

1. On the **Configuration** tab, navigate to **Diagnostics > Technical Support**.
2. In the **details** pane, from the **Action** list, select **Generate Technical Support File**.
3. In the **Generate Technical Support File** dialog box, from the **Mode** list, select the appropriate option.
4. Click **OK**.

#### To download the tar archive for technical support:

1. In the **Technical Support** pane, select the technical support file that you want to download.
2. From the **Action** list, select **Download**. The file is saved to your local computer.

### CLI support for Management Service

You can now use the CLI to perform operations on the Management Service. The following operations are supported:

- Add, Set, Delete—To configure the resources.
- Do—To perform system level operations. For example, management service upgrade or shut-down, or reboot.
- Save—To add interfaces, which are used for provisioning.

To access the CLI, start the secure shell (SSH) client from any workstation connected to the Management Service IP address. Log on by using the administrator credentials.

You can access detailed information about command usage and syntax from the man pages.

**Note:** CLI is not supported over console access.

## Configure authentication and authorization settings

September 22, 2023

Authentication with the NetScaler SDX Management Service can be local or external. With external authentication, the Management Service grants user access based on the response from an external server. The Management Service supports the following external authentication protocols:

- Remote Authentication Dial In User Service (RADIUS)
- Terminal Access Controller Access-Control System (TACACS)
- Lightweight Directory Access Protocol (LDAP)

The Management Service also supports authentication requests from SSH. The SSH authentication supports only keyboard-interactive authentication requests. The authorization of SSH users is limited to admin privileges only. Users with read-only privileges cannot log on through SSH.

To configure authentication, specify the authentication type, and configure an authentication server.

Authorization through the Management Service is local. The Management Service supports two levels of authorization. Users with admin privileges are allowed to perform any action on the management service. Users with read-only privileges are allowed to perform only read operations. The authorization of SSH users is limited to admin privileges only. Users with read-only privileges cannot log on through SSH.

Authorization for RADIUS and LDAP is supported by group extraction. You can set the group extraction attributes during the configuration of RADIUS or LDAP servers on the Management Service. The extracted group name is matched with the group names on the Management Service to determine the privileges given to the user. A user can belong to multiple groups. In that case, if any group to which the user belongs has admin privileges, the user has admin privileges. A Default Authentication group attribute can be set during configuration. This group is considered along with the extracted groups for authorization.

In TACACS authorization, the TACACS server administrator must permit a special command, admin for a user with admin privileges and deny this command for users with read-only privileges. When a user logs on to an SDX appliance, the Management Service checks if the user has permission to run this command. If the user has permission, the user is assigned the admin privileges else the user is assigned read-only privileges.

## Add a user group

Groups are logical sets of users that need to access common information or perform similar kinds of tasks. You can organize users into groups defined by a set of common operations. By providing specific permissions to groups rather than individual users, you can save time when creating users.

If you are using external authentication servers for authentication, groups in SDX can be configured to match groups configured on authentication servers. When a user belonging to a group whose name matches a group on an authentication server, logs on and is authenticated, the user inherits the settings for the group.

### To add a user group

1. On the **Configuration** tab, under **System**, expand **User Administration**, and then click **Groups**.
2. In the details pane, click **Add**.

## ← Create System Group

Group Name\*  
 ⓘ × Please enter value

Group Description

System Access

Permission\*  
 ▼ ⓘ

Configure User Session Timeout

Users

**Available (2)** Select All

nsroot	+
config-user	+

**Configured (0)** Remove All

No items	
----------	--

▶

◀

All Instances

**Create**

3. In the **Create System Group** page, set the following parameters:

- Group Name
- Group Description
- System Access: Select this box to give access to the entire SDX appliance and the instances running on it. Alternatively, for instance-level access, specify the instances under **Instances**.
- Permission
- Configure User Session Timeout
- Users: Database users belonging to the Group. Select the users you want to add to the group.

4. Click **Create** and **Close**.



**Note:** To create a group with admin role on an SDX appliance that is upgraded from version 10.5 to version 11.1, select the “read-write” permission and “System Access” check box. In SDX 10.5, this check box is not available and the values for Permission are “admin” and “read-only”.

## Configure user accounts

A user logs on to the SDX appliance to perform appliance management tasks. To allow a user to access the appliance, you must create a user account on the SDX appliance for that user. Users are authenticated locally, on the appliance.

**Important:** The password applies to the SDX appliance, Management Service, and Citrix Hypervisor. Do not change the password directly on the Citrix Hypervisor.

### To configure a user account

1. On the **Configuration** tab, under **System**, expand **Administration**, and then click **Users**. The Users pane displays a list of existing user accounts, with their permissions.
2. In the **Users** pane, do one of the following:
  - To create a user account, click **Add**.
  - To modify a user account, select the user, and then click **Modify**.
3. In the **Create System User** or **Modify System User** dialog box, set the following parameters:
  - Name\*—The user name of the account. The following characters are allowed in the name: letters a through z and A through Z, numbers 0 through 9, period (.), space, and underscore (\_). Maximum length: 128. You cannot change the name.
  - Password\*—The password for logging on to the appliance. Maximum length: 128
  - Confirm Password\*—The password.
  - Permission\*—The user’s privileges on the appliance. Possible values:
    - admin—The user can perform all administration tasks related to the Management Service.
    - read-only—The user can only monitor the system and change the password of the account.  
Default: admin.
  - Enable External Authentication—Enables external authentication for this user. Management Service attempts external authentication before database user authentication. If this parameter is disabled, the user is not authenticated with the external authentication server.

**Note:** If the remote authentication server is not reachable, the user might lose access to the appliance. In such cases, authentication falls back to the default admin user (`nsroot`).

- **Configure Session Timeout**—Enables you to configure the time period for how long a user can remain active. Specify the following details:
  - **Session Timeout**—The time period for how long a user session can remain active.
  - **Session Timeout Unit**—The timeout unit, in minutes or hours.
- **Groups**—Assign the groups to the user.

\*A required parameter

4. Click **Create** or **OK**, and then click **Close**. The user that you created is listed in the **Users** pane.

### To remove a user account

1. On the **Configuration** tab, in the navigation pane, expand **System**, expand **Administration**, and then click **Users**.
2. In the **Users** pane, select the user account, and then click **Delete**.
3. In the Confirm message box, click **OK**.

### Set the authentication type

From the Management Service interface, you can specify local or external authentication. External authentication is disabled for local users by default. It can be enabled by checking the **Enable External Authentication** option when adding the local user or modifying the settings for the user.

**Important:** External authentication is supported only after you set up a RADIUS, LDAP, or TACACS authentication server.

### To set the authentication type

1. On the **Configuration** tab, under **System**, click **Authentication**.
2. In the details pane, click **Authentication Configuration**.
3. Set the following parameters:
  - **Server Type**—Type of authentication server configured for user authentication. Possible values: LDAP, RADIUS, TACACS, and Local.
  - **Server Name**—Name of the authentication server configured in the Management Service. The menu lists all the servers configured for the selected authentication type.

- Enable fallback local authentication—Alternatively, you can choose to authenticate a user with the local authentication when external authentication fails. This option is enabled by default.
4. Click OK.

## Enable or disable basic authentication

You can authenticate to the Management Service NITRO interface using basic authentication. By default, basic authentication is enabled in the SDX appliance. Perform the following to disable basic authentication using the Management Service interface.

### To disable basic authentication

1. On the **Configuration** tab, click **System**.
2. In the **System Settings** group, click **Change System Settings**.
3. In the Configure System Settings dialog box, clear the **Allow Basic Authentication** check box.
4. Click **OK**.

## Configuring the external authentication server

October 6, 2023

The NetScaler SDX Management Service can authenticate users with local user accounts or by using an external authentication server. The appliance supports the following authentication types:

- Local—Authenticates to the Management Service by using a password, without reference to an external authentication server. User data is stored locally on the Management Service.
- RADIUS—Authenticates to an external RADIUS authentication server.
- LDAP—Authenticates to an external LDAP authentication server.
- TACACS—Authenticates to an external Terminal Access Controller Access-Control System (TACACS) authentication server.

To configure an external authentication, specify the authentication type, and configure an authentication server.

### Adding a RADIUS server

To configure RADIUS authentication, specify the authentication type as RADIUS, and configure the RADIUS authentication server.

Management Service supports RADIUS challenge response authentication according to the RADIUS specifications. RADIUS users can be configured with a one-time password on the RADIUS server. When the user logs on to an SDX appliance the user is prompted to specify this one time password.

### To add a RADIUS server

1. On the **Configuration** tab, under **System**, expand **Authentication**, and then click **Radius**.
2. In the details pane, click **Add**.
3. In the **Create Radius Server** dialogue box, type or select the values for the parameters:
  - **Name\***—Name of the server.
  - **Server Name / IP Address\***—fully qualified domain name (FQDN) or Server IP address.  
**Note:** DNS must be able to resolve the specified FQDN to an IP address, and only the primary DNS is used to resolve the FQDN. To manually set the primary DNS, see the section “Adding a Primary DNS for FQDN Name Resolution.”
  - **Port\***—Port on which the RADIUS server is running. Default value: 1812.
  - **Time-out\***—Number of seconds the system waits for a response from the RADIUS server. Default value: 3.
  - **Secret Key\***—Key shared between the client and the server. This information is required for communication between the system and the RADIUS server.
  - **Enable NAS IP Address Extraction**—If enabled, the Management Service IP address is sent to the server as the `nas ip` in accordance with the RADIUS protocol.
  - **NASID**—If configured, this string is sent to the RADIUS server as the `nas id` in accordance with the RADIUS protocol.
  - **Group Prefix**—Prefix string that precedes group names within a RADIUS attribute for RADIUS group extraction.
  - **Group Vendor ID**—Vendor ID for using RADIUS group extraction.
  - **Group Attribute Type**—Attribute type for RADIUS group extraction.
  - **Group Separator**—Group separator string that delimits group names within a RADIUS attribute for RADIUS group extraction.
  - **IP Address Vendor Identifier**—Vendor ID of the attribute in the RADIUS which denotes the intranet IP. A value of 0 denotes that the attribute is not vendor encoded.
  - **IP Address Attribute Type**—Attribute type of the remote IP address attribute in a RADIUS response.
  - **Password Vendor Identifier**—Vendor ID of the password in the RADIUS response. Used to extract the user password.
  - **Password Attribute Type**—Attribute type of the password attribute in a RADIUS response.
  - **Password Encoding**—How passwords must be encoded in the RADIUS packets traveling from the system to the RADIUS server. Possible values: `pap`, `chap`, `mschapv1`, and `mschapv2`.

- Default Authentication Group—Default group that is chosen when the authentication succeeds in addition to extracted groups.
  - Accounting—Enable Management Service to log audit information with RADIUS server.
4. Click Create, and then, click Close.

## Adding an LDAP authentication server

To configure LDAP authentication, specify the authentication type as LDAP, and configure the LDAP authentication server.

### To add an LDAP server

1. On the **Configuration** tab, under **System**, expand **Authentication**, and then click **LDAP**.
2. In the details pane, click **Add**.
3. In the Create LDAP Server dialogue box, type or select the values for the parameters:
  - Name\*—Name of the server.
  - Server Name / IP Address\*—FQDN or Server IP address.  
**Note:** DNS must be able to resolve the specified FQDN to an IP address, and only the primary DNS is used to resolve the FQDN. To manually set the primary DNS, see the section “Adding a Primary DNS for FQDN Name Resolution.”
  - **Port\***—Port on which the LDAP server is running. Default value: 389.
  - Time-out\*—Number of seconds the system waits for a response from the LDAP server.
  - Base DN—Base, or node where the LDAP search must start.
  - Type—Type of LDAP server. Possible values: Active Directory (AD) and Novell Directory Service (NDS).
  - Administrative Bind DN—Full distinguished name that is used to bind to the LDAP server.
  - Administrative Password—Password that is used to bind to the LDAP server.
  - Validate LDAP Certificate—Check this option to validate the certificate received from the LDAP server.
  - LDAP Host Name—Host name for the LDAP server. If the validateServerCert parameter is enabled, this parameter specifies the host name on the certificate from the LDAP server. A host-name mismatch causes a connection failure.
  - Server Logon Name Attribute—Name attribute used by the system to query the external LDAP server or an Active Directory.

- Search Filter—String to be combined with the default LDAP user search string to form the value. For example, `vpnallowed=true` with `ldaploginname samaccount` and the user-supplied user name `bob` would yield an LDAP search string of: `(&(vpnallowed=true)(samaccount=bob))`.
- Group Attribute—Attribute name for group extraction from the LDAP server.
- Sub Attribute Name—Subattribute name for group extraction from the LDAP server.
- Security Type—Type of encryption for communication between the appliance and the authentication server. Possible values:
  - PLAINTEXT: No encryption required.
  - TLS: Communicate using TLS protocol.
  - SSL: Communicate using SSL Protocol
- Default Authentication Group—Default group that is chosen when the authentication succeeds in addition to extracted groups.
- Referrals—Enable following of LDAP referrals received from LDAP server.
- Maximum LDAP Referrals—Maximum number of LDAP referrals to follow.
- Enable Change Password—Allow the user to modify the password if the password expires. You can change the password only when the Security Type configured is TLS or SSL.
- Enable Nested Group Extraction—Enable Nested Group extraction feature.
- Maximum Nesting Level—Number of levels at which group extraction is allowed.
- Group Name Identifier—Name that uniquely identifies a group in the LDAP server.
- Group Search Attribute—LDAP group search attribute. Used to determine to which groups a group belongs.
- Group Search Subattribute—LDAP group search subattribute. Used to determine to which groups a group belongs.
- Group Search Filter—String to be combined with the default LDAP group search string to form the search value.

4. Click Create, and then click Close.

### **SSH public key authentication support for LDAP users**

The SDX appliance can now authenticate the LDAP users through SSH public key authentication for logon. The list of public keys is stored on the user object in the LDAP server. During authentication, SSH extracts the SSH public keys from the LDAP server. The logon succeeds if any of the retrieved public keys supports SSH.

The same attribute name of the extracted public key must be present in both the LDAP server and in the NetScaler SDX appliance.

**Important**

For key-based authentication, you must specify a location of the public keys by setting the value of `AuthorizedKeysFile` in the `/etc/sshd_config` file in the following aspect:

`AuthorizedKeysFile .ssh/authorized_keys`

**System User.** You can specify the location of public keys for any system user by setting the value of `AuthorizedKeysFile` in the `/etc/sshd_config` file.

**LDAP Users.** The retrieved public key is stored in the `/var/pubkey/<user_name>/tmp_authorized_keys-<pid>` directory. The `pid` is the unique number added to differentiate between concurrent SSH requests from the same user. This location is a temporary location to hold the public key during the authentication process. The public key is removed from the system once authentication is complete.

To log in with the user, run the following command from the shell prompt:

```
$ ssh -i <private key> <username>@<IPAddress>
```

**To configure LDAP server by using the GUI:**

1. Navigate to **System > Authentication > LDAP**.
2. On the LDAP page, click **Servers** tab.
3. Click any of the available LDAP servers.
4. On the **Configure Authentication LDAP Server** page, select **Authentication**.

**Note:**

Clear the Authentication check box to use “sshPublicKeys” for authentication of LDAP users.

**Adding a primary DNS for FQDN name resolution**

If you define a RADIUS or an LDAP server by using the FQDN of the server instead of its IP address, manually set the primary DNS to resolve the server name. You can use either the GUI or CLI.

To set the primary DNS by using the GUI, go to **System > Network Configuration > DNS**.

To set the primary DNS by using the CLI, follow these steps.

1. Open a Secure Shell (SSH) console.
2. Log on to the NetScaler SDX appliance by using the admin credentials.
3. Run the `networkconfig` command.
4. Select the appropriate menu and update the DNS IPv4 Address, and save the changes.

If you run the `networkconfig` command again, you see the updated DNS address.

## Adding a TACACS Server

To configure TACACS authentication, specify the authentication type as TACACS, and configure the TACACS authentication server.

### To add a TACACS server

1. On the **Configuration** tab, under **System**, expand **Authentication**, and then click **TACACS**.
2. In the details pane, click **Add**.
3. In the Create TACACS Server dialogue box, type or select the values for the parameters:
  - Name—Name of the TACAS server
  - IP Address—IP address of the TACACS server
  - Port—Port on which the TACACS Server is running. Default value: 49
  - Time-out—Maximum number of seconds the system waits for a response from the TACACS server
  - TACACS Key—Key shared between the client and the server. This information is required for the system to communicate with the TACACS server
  - Accounting—Enables Management Service to log audit information with TACACAS server
  - Group Attribute Name—Name of the group attribute configured in the TACACS+ server



← Create TACACS Server

Name\*  ⓘ

IP Address\*

Port\*

Time-out (seconds)\*

TACACS Key\*

Confirm TACACS Key\*  ⓘ

Group Attribute Name

Accounting

4. Click **Create**, and then click **Close**.

## Configure link aggregation from the Management Service

August 1, 2023

Link aggregation combines multiple Ethernet links into a single high-speed link. Configuring link aggregation increases the capacity and availability of the communication channel between the NetScaler SDX appliance and other connected devices. An aggregated link is also referred to as a “channel.”

When a network interface is bound to a channel, the channel parameters have precedence over the network interface parameters. (That is, the network interface parameters are ignored.) A network interface can be bound only to one channel.

When a network interface is bound to a channel, it drops its VLAN configuration. The interface is removed from the VLAN that it originally belonged to and added to the default VLAN. However, you can

bind the channel back to the old VLAN, or to a new one. For example, if you bind network interfaces 1/2 and 1/3 to a VLAN with ID 2 (VLAN 2), and then bind them to channel LA/1, the network interfaces are moved to the default VLAN, but you can bind the channel to VLAN 2.

Note:

- An interface must be part of only one channel.
- A minimum of two interfaces are required to configure a channel.
- The interfaces that form part of a channel are not listed in the Network Settings view when you add or modify a NetScaler instance. Instead of the interfaces, the channels are listed.

If you configure a channel by using three interfaces that are assigned to one instance, and a second instance uses some of these interfaces, the Management Service shuts down the second instance, modifies the network settings, and restarts the instance. For example, assume two instances, Instance1 and Instance2. When these instances are provisioned, interfaces 10/1, 10/2, and 10/3 are assigned to Instance1, and interfaces 10/1 and 10/2 are assigned to Instance2. If an LA channel is created with interfaces 10/1, 10/2, and 10/3, instance1 is not restarted. However, the Management Service shuts down Instance2, assigns interface 10/3 to Instance2, and then restarts Instance2.

If you remove an interface from an LA channel, the changes are stored in the database, and the interface appears in the Network Settings view when you add or modify an instance. Before you delete the interface, only the channel that the interface is a part of is listed.

## Configuring a channel from the Management Service

August 1, 2023

You can configure a channel manually, or you can use the Link Aggregation Control Protocol (LACP). You cannot apply LACP to a manually configured channel, nor can you manually configure a channel created by LACP. Configure a channel from the Management Service. Then select the channel at the time of provisioning or modifying a NetScaler instance.

An LA Channel is a logical entity to provide for link redundancy and bandwidth aggregation. Interfaces that are part of a channel cannot be assigned separate IP addresses.

**Note:** A NetScaler SDX appliance supports link aggregation but does not support link redundancy. From NetScaler release 13.1 build 27.x and later, link redundancy configuration is explicitly not supported on a NetScaler VPX instance hosted on a NetScaler SDX appliance.

### To configure a channel from the Management Service

1. Navigate to **System > Channels**.

2. In the details pane, click **Add**.
3. In the **Add Channel** dialog box, set the following parameters:
  - Channel ID—ID for the LA channel to be created. Specify an LA channel in LA/x notation, where x can range from 1 to a number equal to one-half the number of interfaces. Cannot be changed after the LA channel is created.
  - Type—Type of channel. Possible values:
    - Static—configured only on the data interfaces.
    - Active-Active—configured only on the management interfaces 0/x.
    - Active-Passive—configured only on the management interfaces 0/x.
    - LACP—configured on data interfaces and the management interfaces 0/x.
  - Throughput (Applies only to a static channel and LACP)—Low threshold value for the throughput of the LA channel, in Mbps. In an HA configuration, failover is triggered if the LA channel has HA MON enabled and the throughput is below the specified threshold.
  - Bandwidth High (Applies only to a static channel and LACP)—High threshold value for the bandwidth usage of the LA channel, in Mbps. The appliance generates an SNMP trap message when the bandwidth usage of the LA channel is equal to or greater than the specified high threshold value.
  - Bandwidth Normal (Applies only to a static channel and LACP)—Normal threshold value for the bandwidth usage of the LA channel, in Mbps. When the bandwidth usage of the LA channel becomes equal to or less than the specified normal threshold after exceeding the high threshold, the NetScaler SDX appliance generates an SNMP trap message to indicate that bandwidth usage has returned to normal.
4. On the **Interfaces** tab, add the interfaces that you want to include in this channel.
5. On the **Settings** tab, set the following parameters:
  - Channel State (Applies only to a static channel)—Enable or disable the LA channel.
  - LACP Time (Applies only to LACP)—Time after which a link is not aggregated if the link does not receive an LACPDU. The value must match on all the ports participating in link aggregation on the SDX appliance and the partner node.
  - HA Monitoring—In a High Availability (HA) configuration, monitor the channel for failure events. Failure of any LA channel that has HA MON enabled triggers HA failover.
  - Tag All—Add a four-byte 802.1q tag to every packet sent on this channel. The ON setting applies tags for all VLANs that are bound to this channel. OFF applies the tag for all VLANs other than the native VLAN.
  - Alias Name—Alias name for the LA channel. Used only to enhance readability. To perform any operations, you have to specify the LA channel ID.
6. Click **Create**, and then click **Close**.

### Notes

- You cannot create a management LA if both 0/1 and 0/2 interfaces are part of a VPX instance, and that instance is part of a cluster.
- You cannot delete a management LA if it is part of a VPX instance, and that instance is part of a cluster.

## Access control lists

December 14, 2023

An access control list (ACL) is a set of conditions that you can apply to a network appliance to filter IP traffic and secure your appliance from unauthorized access.

You can configure an ACL on your NetScaler SDX Management Service GUI to limit and control access to the appliance.

### Note:

ACLs on SDX appliances are supported from release 12.0 57.19 onwards.

This topic includes the following sections:

- Usage guidelines
- How to configure ACLs
- Other actions for ACL rules
- Troubleshooting

## Usage guidelines

Keep the following points in mind while creating ACLs on your appliance:

- When you upgrade the SDX appliance to release 11.0 57.19, the ACL feature is disabled by default.
- SDX administrators can control only inbound packets through ACL on the SDX appliance.
- If you use NetScaler Application Delivery Management to manage your SDX appliance, you must create appropriate ACL rules to allow communication between MAS and the SDX Management Service.
- Any other configurations on the SDX appliance such as provisioning or deleting VPXs, adding/deleting external servers, SNMP management, do not require any changes in the existing ACL configuration. Communication with these entities is taken care of by the Management Service.

## How to Configure an ACL

Configuring an ACL involves the following steps:

- Enable the ACL feature
- Create an ACL rule
- Enable the ACL rule

### Note:

You can create ACL rules without enabling the ACL feature. However, if the feature is not enabled, you cannot enable an ACL rule after you've created it.

### Enable the ACL feature

1. To enable the ACL feature, log on to the SDX Management Service GUI and navigate to **Configuration > System > ACL**.
2. By using the toggle button, turn on the ACL feature.

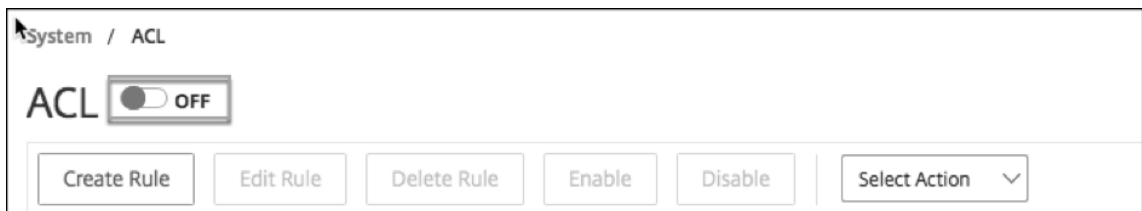

### Create an ACL rule

1. On the ACL page, click **Create Rule**.
2. The **Create Rule** window opens. Add the details listed in the following table.

Property	Description
Name	Add a name.
Protocol	Select a protocol from the menu. By default, TCP is selected. You can select <b>ANY</b> to allow all protocols.
Source IP Address/Subnet	Specify the source IP address or source subnet to which the rule applies. Select <b>ANY</b> if the rule must be applied to all incoming traffic.

Property	Description
Destination IP	The SDX Management Service IP address is autopopulated as the destination IP. This field cannot be edited.
Destination port	Specify the destination port to which the rule applies. Select <b>ANY</b> if the rule applies to all destination ports.
Action	Select the action for the rule, which is Allow or Deny.
Priority	Assign priority to specify the order in which the rule is to be evaluated. Priority numbers determine the order in which ACL rules are matched against an incoming packet. A lower priority number has a higher priority. For example, priority number 1 has a higher priority than priority number 1. If none of the rules match with the incoming packet, then the packet is blocked.

3. Click **OK** to create the rule.

**Figure:** An example of an ACL rule

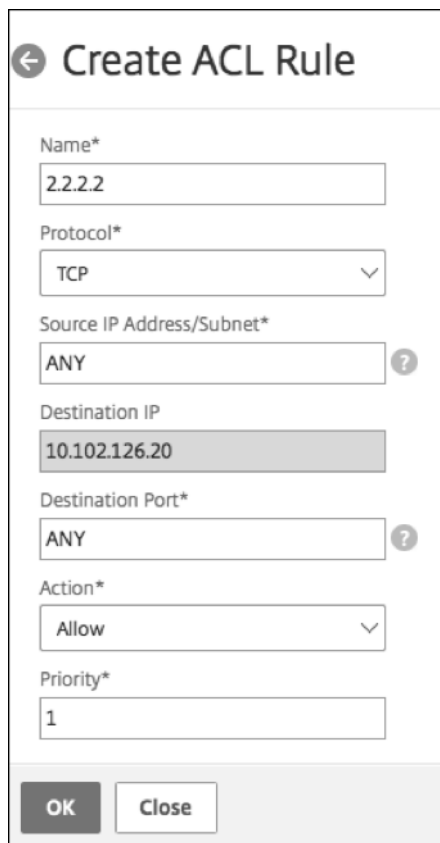

← Create ACL Rule

Name\*  
2.2.2.2

Protocol\*  
TCP

Source IP Address/Subnet\*  
ANY ?

Destination IP  
10.102.126.20

Destination Port\*  
ANY ?

Action\*  
Allow

Priority\*  
1

OK Close

After the rule is created, it is in the disabled state. To make the rule effective, you must enable the rule.

**Note:**

To enable a rule, the ACL feature must be enabled. If the feature is disabled, and you attempt to enable an ACL rule, a message “ACL is not running” appears.

### Enable an ACL rule

1. Hover your mouse over the rule that you want to enable and click the circle with three dots.
2. From the menu, select **Enable**.
3. Alternatively, select the radio button for that rule and click the **Enable** tab.
4. At the prompt, click **Yes** to confirm.

### Other actions for ACL rules

You can apply the following actions to the ACL rules:

1. Disable an ACL rule

2. Edit an ACL rule
3. Delete an ACL rule
4. Renumber the priority of ACL rules

### Disable an ACL rule

1. Hover the mouse over the rule that you want to disable and select the circle with three dots.
2. Click **Disable** from the list.
3. Alternatively, select the radio button for that rule and click the **Disable** tab.
4. Click **Yes** to confirm.

#### Note:

When you disable a rule, the rule no longer applies to incoming traffic. However, the rule configuration remains under ACL settings.

### Edit an ACL rule

1. Hover the mouse over the rule that you want to edit and select the circle with three dots.
2. Click **Edit Rule** from the list. The **Modify Rule** window opens.
3. Alternatively, select the radio button for that rule and click the **Edit Rule** tab. The **Modify Rule** window opens
4. Make the edits and click **OK**.

#### Note:

You can edit a rule in both enabled and disabled state. If you edit a rule that is already enabled, the edits get applied immediately. For a rule in the disabled state, the edits get applied when you enable the rule.

### Delete an ACL rule

1. Ensure that the rule is in the disabled state.
2. Hover the mouse over the rule that you want to delete and select the circle with three dots. Click **Delete Rule** from the list.
3. Alternatively, select the radio button for that rule and click the **Delete Rule** tab.
4. Click **Yes** to confirm.



**Note:**

You cannot delete a rule in the enabled state.

**Renumber priorities of ACL rules**

1. Hover the mouse over the rule that you want to renumber the priorities for and select the circle with three dots. Click **Renumber Priority(s)** from the list.
2. Alternatively, select the radio button for that rule and click the **Select Action** tab.
3. Select **Renumber Priority(s)**.
4. The SDX Management Service automatically assigns new priority numbers, which are multiples of 10, to all the existing rules.
5. Edit the rules to assign priority numbers according to your requirement. See the “To edit an ACL rule” section for more information about how to edit a rule.

**Figure.** An example of existing priority numbers

<input type="checkbox"/>	Priority ↑	Name	Source IP Address/Subnet
<input type="checkbox"/>	1	2.2.2.2	ANY
<input type="checkbox"/>	2	test1	1.1.1.1
<input type="checkbox"/>	3	test2	ANY

**Figure.** An example of priority numbers in multiples of 10, after priorities are renumbered

<input type="checkbox"/>	Priority ↑	Name	Source IP Address/Subnet
<input type="checkbox"/>	10	2.2.2.2	ANY
<input type="checkbox"/>	20	test1	1.1.1.1
<input type="checkbox"/>	30	test2	ANY

**Troubleshooting**

If ACL rules are improperly set up, all user accounts can be denied access. If you inadvertently lose all network access to the SDX Management Service because of improper ACL setup, follow these steps to gain access.

1. Log on to the Citrix Hypervisor management IP address by using SSH and your “root” account.

2. Log on to the console of the Management Service VM by using admin privileges.
3. Run the command `pfctl -d`.
4. Log on to the Management Service through the GUI and reconfigure the ACL accordingly.

## Set up a cluster of NetScaler instances

August 1, 2023

After provisioning NetScaler instances on one or more SDX appliances, you can create a cluster of NetScaler instances.

Citrix recommends that you perform the cluster configuration from the Management Service. When you perform the cluster configuration from a VPX instance, the Management Service learns about the configuration during automatic discovery every 30 minutes. In the worst case, the clustering information is not discovered for 30 minutes. While the cluster might work properly, some essential validation checks for cluster dependencies are missed. The Management Service performs these checks before configuring the cluster on ADC instances. Therefore, you must perform any cluster configuration from the Management Service.

### Note:

- To set up a cluster, you must understand NetScaler clustering. For more information, see [Clustering](#).
- For clusters that have NetScaler instances across SDX appliances, Citrix recommends that you use NetScaler instances from three SDX appliances. This process ensures that the cluster criteria of a minimum of  $(n/2 + 1)$  nodes is always satisfied.

Figure 1. Cluster of SDX NetScaler instances

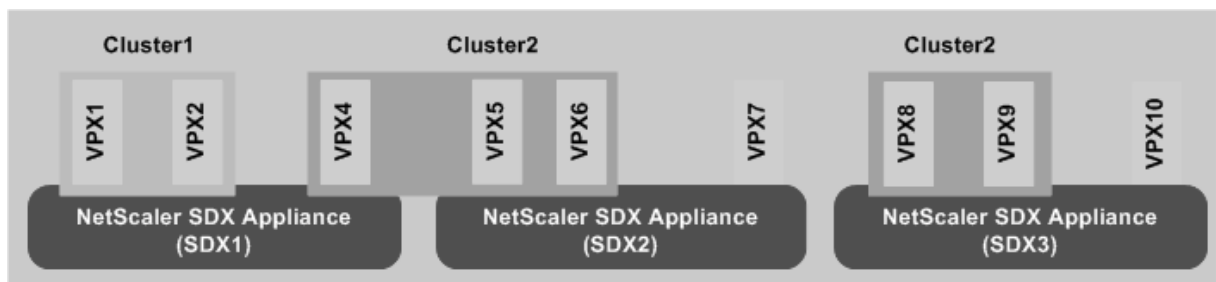

The preceding figure shows three SDX appliances, SDX1, SDX2, and SDX3, on the same subnet. The NetScaler instances on these appliances are used to form two clusters: Cluster1 and Cluster2.

- Cluster1 includes two instances on SDX1.

- Cluster2 includes one instance on SDX1, two instances on SDX2, and another two instances on SDX3.

### Points to remember

- CLAG formation with Mellanox interfaces (50G and 100G) is not supported on an SDX platform.
- All nodes of a cluster must be of the same type. You cannot form a cluster with the following combinations:
  - Hardware and virtual appliances.
  - NetScaler VPX instances and NetScaler SDX instances.
  - ADC instances on different SDX hardware platforms.
- The NetScaler instances must be of the same version, which must be version 10.1 or later.
- The NetScaler instances must all have the same feature license.
- No configurations can be updated on individual NetScaler instances after they are added to the cluster. All changes must be performed through the cluster IP address.
- The NetScaler instances must all have the same resources (memory, CPU, interfaces, and so on).
- The backplane MTU must be 78 bytes more than the data interface MTU.
- Ensure that any data interface MTU is within 9138 bytes.
- From release 13.0 build 82.x, you are prompted to add a SNIP address while adding a node to a cluster. You can also create SNIP addresses dynamically while adding a node. This feature helps address the security issues on strict source IP address check.
- **Important!** Use the **Remove Cluster** option with caution. When you click **Remove Cluster**, the cluster is deleted without any warning.

### Set up a cluster on an SDX appliance

1. Log on to the SDX appliance.
2. On the **Configuration** tab, navigate to **NetScaler > Clusters > Cluster Instances**.
3. Create the cluster:
  - a) Click **Create Cluster**.
  - b) In the **Create Cluster** dialog box, set the parameters required for the cluster. For the description of a parameter, hover the mouse cursor over the corresponding field.
  - c) Click **Next** to view the configuration summary.
  - d) Click **Finish** to create the cluster.

Note: When a NetScaler instance with L2 VLAN configured is added to the cluster, then the add VLAN command is saved with the

`sdxvlan` parameter set to Yes. This parameter is an internal argument and is used to avoid loss of connectivity during SDX cluster formation.

4. Add nodes to the cluster:

- a) Click **Add Node**.
- b) In the **Add Node** dialog box, configure the parameters required for adding a cluster node. For a description of a parameter, hover the mouse cursor over the corresponding field.
- c) Click **Next** to view the configuration summary.
- d) Click **Finish** to add the node to the cluster.
- e) Repeat steps 1 through 4 to add another node to the cluster.

After creating the cluster, you must configure it by accessing it through the cluster IP address.

If the nodes in a cluster instance belong to the same Citrix NetScaler SDX appliance, we might lose the quorum when a NetScaler SDX appliance fails.

You can deploy a cluster node using following methods:

1. Create multiple cluster instances with one VPX instance from each NetScaler SDX appliance.

**Example:**

SDX1	SDX2	InstanceID
VPX1	VPX1	1
VPX2	VPX2	2

1. If there are more than two NetScaler SDX appliances, then create a single cluster instance with VPX instances from all the appliances with `quorumType Majority`. In this case, make sure the VPX instances are distributed equally across all the NetScaler SDX appliances.

**Example1:**

SDX1	SDX2	SDX3	InstanceID
VPX1	VPX1	VPX1	1
VPX2	VPX2	VPX2	NA
VPX3	VPX3	VPX3	NA

**Example2:**

SDX1	SDX2	SDX3	InstanceID
VPX1	VPX1	VPX1	1
VPX2	VPX2	VPX2	NA
VPX3	VPX3	VPX3	NA
VPX4	NA	NA	NA

1. Create a single cluster instance with all the VPX instances from all the NetScaler SDX devices. But use `quorum type NONE`. This has some limitations.

**Example:**

SDX1	SDX2	InstanceID
VPX1	VPX1	1
VPX2	VPX2	2
VPX3	NA	NA

**Limitations when the `-quorumType` parameter is set to `NONE`:**

- Topologies must have redundant links between cluster nodes to avoid network partition due to a single point of failure.
- The cluster might become unstable during any cluster operations such as node addition or removal.

**Note:**

To get an updated list of NetScaler clusters, each of which has at least one NetScaler instance of the SDX appliance, use the **Rediscover** option.

**Add a NetScaler instance that exists on one SDX appliance to a cluster configured on another SDX appliance**

1. Log on to the SDX appliance from which you want to add the NetScaler instance.
2. On the **Configuration** tab, navigate to **NetScaler**, and then click **Clusters**.
3. Click **Add Node**.
4. In the **Add Node** dialog box, configure the parameters required for adding a cluster node. For a description of a parameter, hover the mouse cursor over the corresponding field.

Note: Make sure the values of the

Cluster IP address and

Cluster IP Password parameters are for the cluster to which you want to add the node.

5. Click **Next** to view the configuration summary.
6. Click **Finish** to add the node to the cluster.

## Configuring cluster link aggregation

December 14, 2023

Cluster link aggregation, as the name suggests, combines a group of cluster-node interfaces into a channel. It is an extension of NetScaler link aggregation (LA). The only difference is that, while link aggregation requires the interfaces to be on the same device, in cluster link aggregation, the interfaces are on different nodes of the cluster. For more information about link aggregation, see [Configuring Link Aggregation](#).

For example, consider a six-node cluster, across two SDX appliances, in which all six nodes are connected to an upstream switch. A cluster LA channel (CLA/1) is formed by binding interfaces 0/1/2, 1/1/3, 2/1/4, 3/1/2, 4/1/3, and 5/1/4.

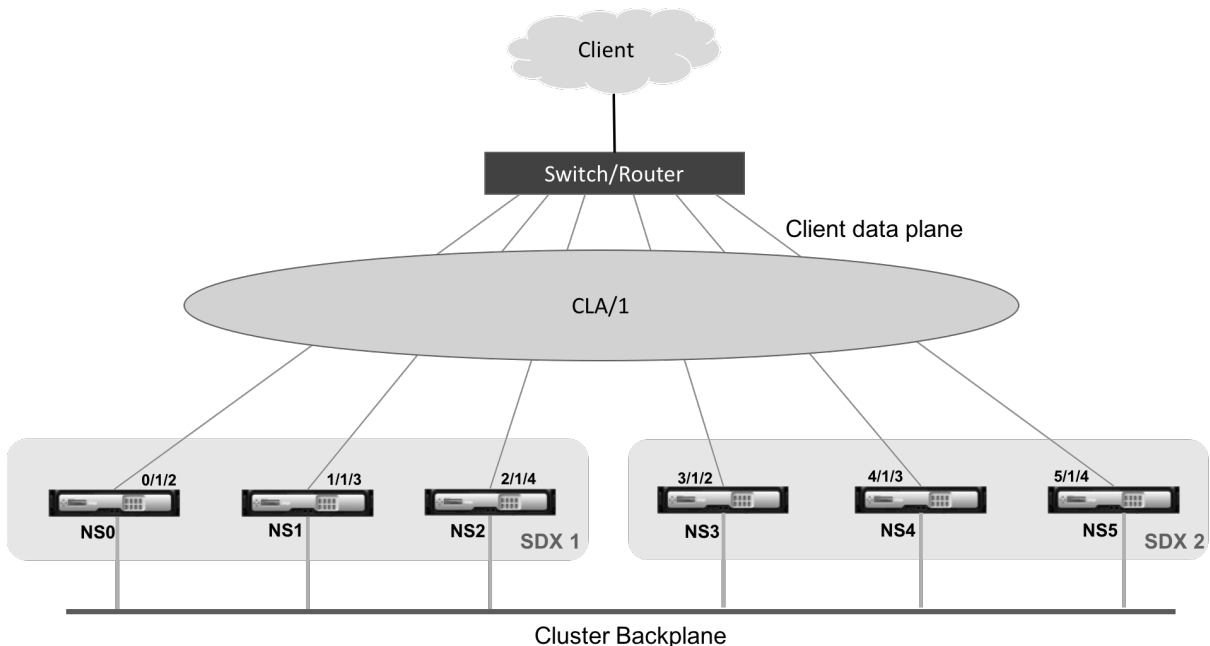

A cluster LA channel has the following attributes:

- Each channel has a unique MAC address agreed upon by cluster nodes.
- The channel can bind both local and remote SDX nodes' interfaces.
- A maximum of four cluster LA channels are supported in a cluster.

- A maximum of 16 interfaces can be bound to each cluster LA channel.
- Backplane interfaces cannot be part of a cluster LA channel.
- When an interface is bound to a cluster LA channel, the channel parameters take precedence over the network interface parameters.
- A network interface can be bound to only one channel.
- Do not configure management access to a cluster node on a cluster LA channel (for example, CLA/1) or its member interfaces. When the node is INACTIVE, the corresponding cluster LA interface is marked as POWER OFF, which causes it to lose management access.

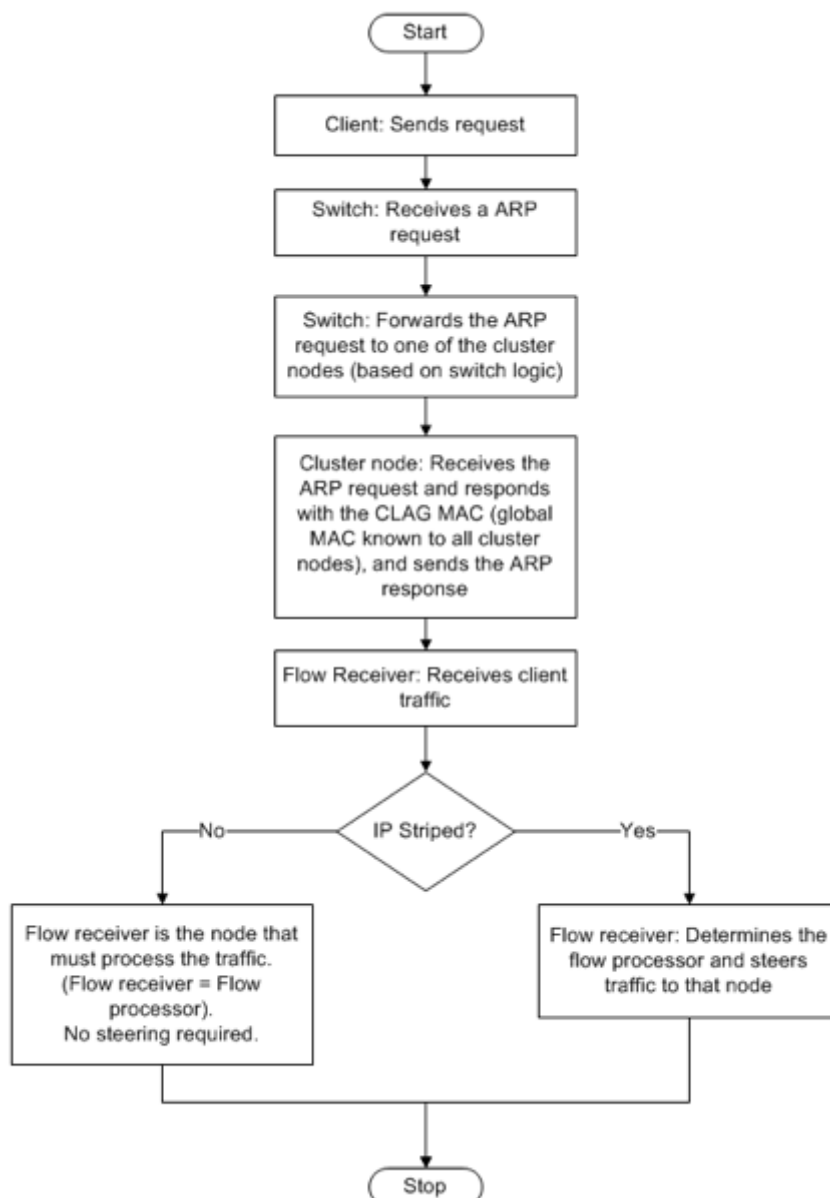

Implement similar configurations on the cluster IP address and on the external connecting device. If possible, configure the upstream switch to distribute traffic based on the IP address or port instead of

the MAC address.

**Points to remember:**

- Enable LACP (by specifying the LACP mode as either ACTIVE or PASSIVE).  
**Note:** Make sure the LACP mode is not set as PASSIVE on both the NetScaler cluster and the external connecting device.
- For creating a cluster LA channel, the LACP key can have a value from 5 through 8. These LACP Keys are mapped to CLA/1, CLA/2, CLA/3, and CLA/4.
- On the SDX appliance, the cluster link aggregation group (CLAG) member interfaces cannot be shared with other virtual machines.
- On the upstream switch, set LACP timeout to “short” to avoid long-duration traffic black holes on cluster nodes. This setting is useful when the upstream switch is not notified of the power down of the CLAG and its member interfaces until after the LACP timeout.

**Prerequisites:**

Create a cluster of NetScaler instances. The nodes of the cluster can be NetScaler instances on the same SDX appliance or on other SDX appliances that are available on the same subnet.

**To configure a cluster LA channel by using the Management Service:**

1. Log on to the SDX appliance.
2. On the **Configuration** tab, navigate to **Citrix ADC**, and then click **Clusters**.
3. On the **Cluster Instances** page, select the cluster and click **CLAG**.

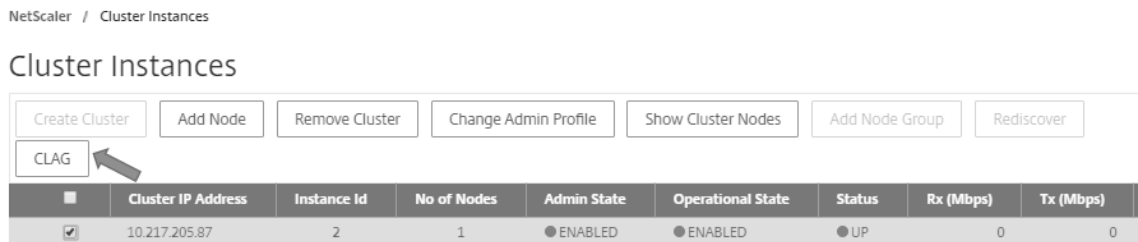

4. In the **Create CLAG** dialog box, do the following:
  - a) In the **Channel ID** drop-down list, select the cluster LA channel ID.
  - b) In the **Interfaces** section, from the **Available** selection box, select the interfaces and click **+**.
  - c) The selected interfaces are displayed under **Configured** selection box.
5. In the **Setting** section, do the following:
  - a) In the **Alias** field, enter an alternative name for the cluster LA channel.



- b) In the **LACP Timeout** field, select one of the following values to define the interval after which a link is not aggregated, if the link does not receive an LACPDU.  
 The value must match on all the ports participating in link aggregation on the SDX appliance and the partner node:
    - **Long** –30 seconds
    - **Short** –1 second
  - c) For High Availability (HA) configuration, select the **HA Monitoring** check box to monitor the channel for failure events. Failure of any LA channel that has HA MON enabled triggers HA failover.
  - d) Select **Tag All** to add a four-byte 802.1q tag to every packet sent on this channel. The **ON** setting applies tags for all VLANs that are bound to this channel. OFF applies the tag to all VLANs other than the native VLAN.
6. Click **Create** to configure a CLAG for one of the SDX appliances.

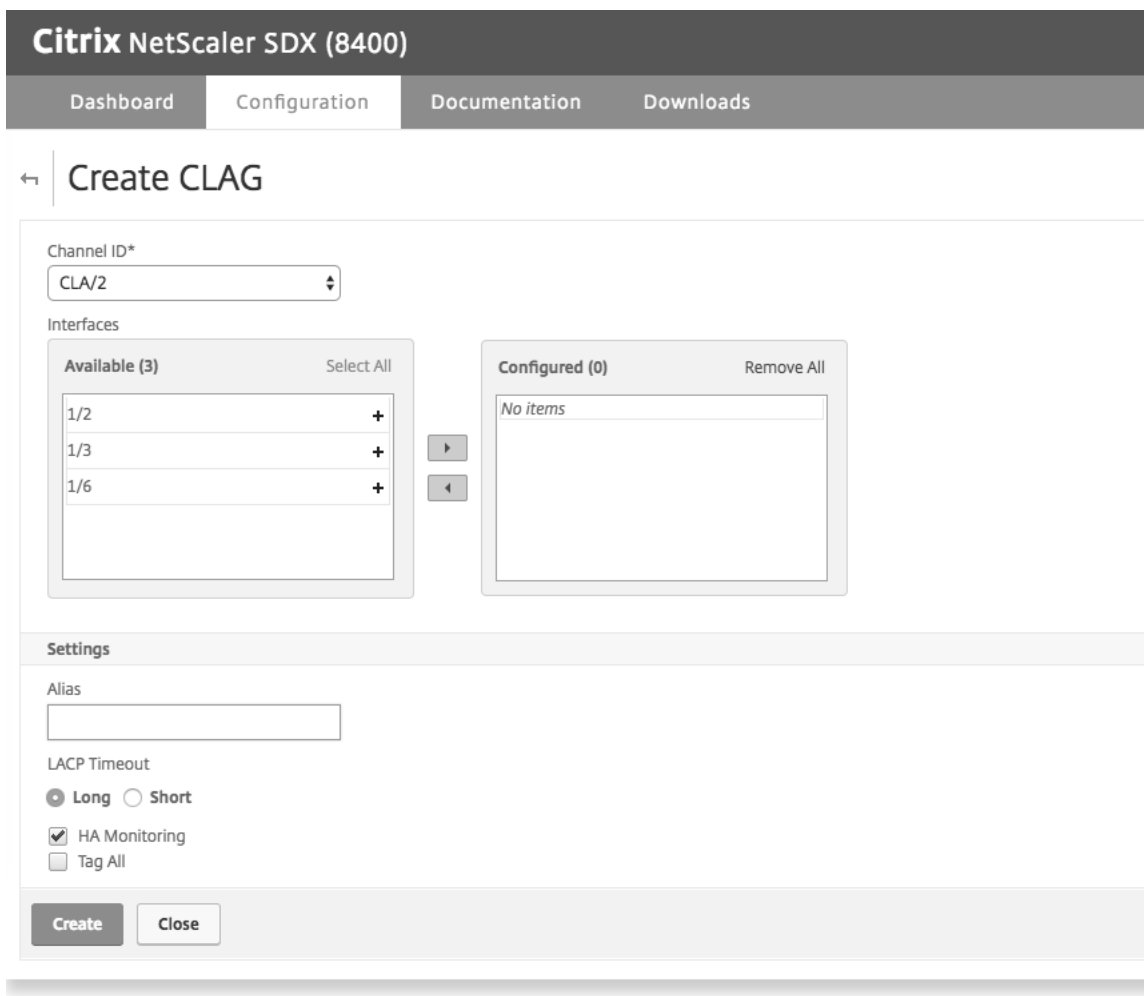

- 7. In the **Confirm** dialog box, click **Yes** to refresh the CLAG settings in the other SDX appliances.

**Notes:**

- If you select **No**, the CLAG is not configured.
- Manually refresh the CLAG settings in the other SDX appliances.
- The MTU settings must be the same on both of the SDX appliances. The MTU settings must be changed manually on either of the SDX appliances.

8. To change the MTU settings in the **CLAGs** dialog box, do the following:
  - a) Select **CLA/1** and click **Edit**.
  - b) In the **Configure CLAG** dialog box, set the MTU manually in the **MTU** field and click **OK**.
9. In the **Confirm** dialog box, click **Yes**.

## Configure SSL ciphers to securely access the Management Service

December 12, 2023

You can select SSL cipher suites from a list of SSL ciphers supported by NetScaler SDX appliances. Bind any combination of the SSL ciphers to access the SDX Management Service securely through HTTPS. An SDX appliance provides 37 predefined cipher groups, which are combinations of similar ciphers, and you can create custom cipher groups from the list of supported SSL ciphers.

### Limitations

- Binding ciphers with key exchange = “DH” or “ECC-DHE” is not supported.
- Binding the ciphers with Authentication = “DSS” is not supported.
- Binding ciphers that are not part of the supported SSL ciphers list, or including these ciphers in a custom cipher group, is not supported.

### Supported SSL Ciphers

The following table lists the supported SSL ciphers. The value in the **Protocol** column is the lowest supported protocol. For example, if SSLv3 is listed, then SSLv3/TLSv1/TLSv1.1/TLSv1.2 are all supported.

Citrix Cipher Name	OpenSSL CipherName	Hex Code	Protocol	Key Exchange Algorithm	Authentication Algorithm	Message Authentication Code Algorithm
TLS1-AES-256-CBC-SHA	AES256-SHA	0x0035	SSLv3	RSA	RSA	AES(256)
TLS1-AES-128-CBC-SHA	AES128-SHA	0x002F	SSLv3	RSA	RSA	AES(128)
TLS1.2-AES-256-SHA256	AES256-SHA256	0x003D	TLSv1.2	RSA	RSA	AES(256)
TLS1.2-AES-128-SHA256	AES128-SHA256	0x003C	TLSv1.2	RSA	RSA	AES(128)
TLS1.2-AES256-GCM-SHA384	AES256-GCM-SHA384	0x009D	TLSv1.2	RSA	RSA	AES-GCM(256)
TLS1.2-AES128-GCM-SHA256	AES128-GCM-SHA256	0x009C	TLSv1.2	RSA	RSA	AES-GCM(128)
TLS1-ECDHE-RSA-AES256-SHA	ECDHE-RSA-AES256-SHA	0xC014	SSLv3	ECC-DHE	RSA	AES(256)
TLS1-ECDHE-RSA-AES128-SHA	ECDHE-RSA-AES128-SHA	0xC013	SSLv3	ECC-DHE	RSA	AES(128)
TLS1.2-ECDHE-RSA-AES-256-SHA384	ECDHE-RSA-AES256-SHA384	0xC028	TLSv1.2	ECC-DHE	RSA	AES(256)
TLS1.2-ECDHE-RSA-AES-128-SHA256	ECDHE-RSA-AES128-SHA256	0xC027	TLSv1.2	ECC-DHE	RSA	AES(128)

Citrix Cipher Name	OpenSSL CipherName	Hex Code	Protocol	Key Exchange Algorithm	Authentication Algorithm	Message Authentication Code Algorithm
TLS1.2-ECDHE-RSA-AES256-GCM-SHA384	ECDHE-RSA-AES256-GCM-SHA384	0xC030	TLSv1.2	ECC-DHE	RSA	AES-GCM(256)
TLS1.2-ECDHE-RSA-AES128-GCM-SHA256	ECDHE-RSA-AES128-GCM-SHA256	0xC02F	TLSv1.2	ECC-DHE	RSA	AES-GCM(128)
TLS1.2-DHE-RSA-AES256-SHA256	DHE-RSA-AES256-SHA256	0x006B	TLSv1.2	DH	RSA	AES(256)
TLS1.2-DHE-RSA-AES128-SHA256	DHE-RSA-AES128-SHA256	0x0067	TLSv1.2	DH	RSA	AES(128)
TLS1.2-DHE-RSA-AES256-GCM-SHA384	DHE-RSA-AES256-GCM-SHA384	0x009F	TLSv1.2	DH	RSA	AES-GCM(256)
TLS1.2-DHE-RSA-AES128-GCM-SHA256	DHE-RSA-AES128-GCM-SHA256	0x009E	TLSv1.2	DH	RSA	AES-GCM(128)
TLS1-DHE-RSA-AES256-CBC-SHA	DHE-RSA-AES256-SHA	0x0039	SSLv3	DH	RSA	AES(256)

Citrix Cipher Name	OpenSSL CipherName	Hex Code	Protocol	Key Exchange Algorithm	Authentication Algorithm	Message Authentication Code Algorithm
TLS1-DHE-RSA-AES-128-CBC-SHA	DHE-RSA-AES128-SHA	0x0033	SSLv3	DH	RSA	AES(128)
TLS1-DHE-DSS-AES-256-CBC-SHA	DHE-DSS-AES256-SHA	0x0038	SSLv3	DH	DSS	AES(256)
TLS1-DHE-DSS-AES-128-CBC-SHA	DHE-DSS-AES128-SHA	0x0032	SSLv3	DH	DSS	AES(128)
TLS1-ECDHE-RSA-DES-CBC3-SHA	ECDHE-RSA-DES-CBC3-SHA	0xC012	SSLv3	ECC-DHE	RSA	3DES(168)
SSL3-EDH-RSA-DES-CBC3-SHA	EDH-RSA-DES-CBC3-SHA	0x0016	SSLv3	DH	RSA	3DES(168)
SSL3-EDH-DSS-DES-CBC3-SHA	EDH-DSS-DES-CBC3-SHA	0x0013	SSLv3	DH	DSS	3DES(168)
TLS1-ECDHE-RSA-RC4-SHA	ECDHE-RSA-RC4-SHA	0xC011	SSLv3	ECC-DHE	RSA	RC4(128)
SSL3-DES-CBC3-SHA	DES-CBC3-SHA	0x000A	SSLv3	RSA	RSA	3DES(168)
SSL3-RC4-SHA	RC4-SHA	0x0005	SSLv3	RSA	RSA	RC4(128)
SSL3-RC4-MD5	RC4-MD5	0x0004	SSLv3	RSA	RSA	RC4(128)
SSL3-DES-CBC-SHA	DES-CBC-SHA	0x0009	SSLv3	RSA	RSA	DES(56)
SSL3-EXP-RC4-MD5	EXP-RC4-MD5	0x0003	SSLv3	RSA(512)	RSA	RC4(40)

Citrix Cipher Name	OpenSSL CipherName	Hex Code	Protocol	Key Exchange Algorithm	Authentication Algorithm	Message Authentication Code Algorithm
SSL3-EXP-DES-CBC-SHA	EXP-DES-CBC-SHA	0x0008	SSLv3	RSA(512)	RSA	DES(40)
SSL3-EXP-RC2-CBC-MD5	EXP-RC2-CBC-MD5	0x0006	SSLv3	RSA(512)	RSA	RC2(40)
SSL2-DES-CBC-MD5	DHE-DSS-AES128-SHA256	0x0040	SSLv2	RSA	RSA	DES(56)
SSL3-EDH-DSS-DES-CBC-SHA	EDH-DSS-DES-CBC-SHA	0x0012	SSLv3	DH	DSS	DES(56)
SSL3-EXP-EDH-DSS-DES-CBC-SHA	EXP-EDH-DSS-DES-CBC-SHA	0x0011	SSLv3	DH(512)	DSS	DES(40)
SSL3-EDH-RSA-DES-CBC-SHA	EDH-RSA-DES-CBC-SHA	0x0015	SSLv3	DH	RSA	DES(56)
SSL3-EXP-EDH-RSA-DES-CBC-SHA	EXP-EDH-RSA-DES-CBC-SHA	0x0014	SSLv3	DH(512)	RSA	DES(40)
SSL3-ADH-RC4-MD5	ADH-RC4-MD5	0x0018	SSLv3	DH	None	RC4(128)
SSL3-ADH-DES-CBC3-SHA	ADH-DES-CBC3-SHA	0x001B	SSLv3	DH	None	3DES(168)
SSL3-ADH-DES-CBC-SHA	ADH-DES-CBC-SHA	0x001A	SSLv3	DH	None	DES(56)
TLS1-ADH-AES-128-CBC-SHA	ADH-AES128-SHA	0x0034	SSLv3	DH	None	AES(128)

Citrix Cipher Name	OpenSSL CipherName	Hex Code	Protocol	Key Exchange Algorithm	Authentication Algorithm	Message Authentication Code Algorithm
TLS1-ADH-AES-256-CBC-SHA	ADH-AES256-SHA	0x003A	SSLv3	DH	None	AES(256)
SSL3-EXP-ADH-RC4-MD5	EXP-ADH-RC4-MD5	0x0017	SSLv3	DH(512)	None	RC4(40)
SSL3-EXP-ADH-DES-CBC-SHA	EXP-ADH-DES-CBC-SHA	0x0019	SSLv3	DH(512)	None	DES(40)
SSL3-NULL-MD5	NULL-MD5	0x0001	SSLv3	RSA	RSA	None
SSL3-NULL-SHA	NULL-SHA	0x0002	SSLv3	RSA	RSA	None

### Predefined cipher groups

The following table lists the predefined cipher groups provided by the SDX appliance.

Cipher Group Name	Description
ALL	All ciphers supported by the SDX appliance, excluding NULL ciphers
DEFAULT	Default cipher list with encryption strength >= 128bit
kRSA	Ciphers with Key-ex algo as RSA
kEDH	Ciphers with Key-ex algo as Ephemeral-DH
DH	Ciphers with Key-ex algo as DH
EDH	Ciphers with Key-ex/Auth algo as DH
aRSA	Ciphers with Auth algo as RSA
aDSS	Ciphers with Auth algo as DSS
aNULL	Ciphers with Auth algo as NULL
DSS	Ciphers with Auth algo as DSS

---

Cipher Group Name	Description
DES	Ciphers with Enc algo as DES
3DES	Ciphers with Enc algo as 3DES
RC4	Ciphers with Enc algo as RC4
RC2	Ciphers with Enc algo as RC2
NULL	Ciphers with Enc algo as NULL
MD5	Ciphers with MAC algo as MD5
SHA1	Ciphers with MAC algo as SHA-1
SHA	Ciphers with MAC algo as SHA
NULL	Ciphers with Enc algo as NULL
RSA	Ciphers with Key-ex/Auth algo as RSA
ADH	Ciphers with Key-ex algo as DH and Auth algo as NULL
SSLv2	SSLv2 protocol ciphers
SSLv3	SSLv3 protocol ciphers
TLSv1	SSLv3/TLSv1 protocol ciphers
TLSv1_ONLY	TLSv1 protocol ciphers
EXP	Export ciphers
EXPORT	Export ciphers
EXPORT40	Export ciphers with 40bit encryption
EXPORT56	Export ciphers with 56bit encryption
LOW	Low strength ciphers (56bit encryption)
MEDIUM	Medium strength ciphers (128bit encryption)
HIGH	High strength ciphers (168bit encryption)
AES	AES Ciphers
FIPS	FIPS Approved Ciphers
ECDHE	Elliptic Curve Ephemeral DH Ciphers
AES-GCM	Ciphers with Enc algo as AES-GCM
SHA2	Ciphers with MAC algo as SHA-2

---



## View the predefined cipher groups

To view the predefined cipher groups, on the **Configuration** tab, in the navigation pane, expand **Management Service**, and then click **Cipher Groups**.

## Create custom cipher groups

You can create custom cipher groups from the list of supported SSL ciphers.

### To create custom cipher groups:

1. On the **Configuration** tab, in the navigation pane, expand **Management Service**, and then click **Cipher Groups**.
2. In the **Cipher Groups** pane, click **Add**.
3. In the **Create Cipher Group** dialog box, perform the following:
  - a) In the **Group Name** field, enter a name for the custom cipher group.
  - b) In the **Cipher Group Description** field, enter a brief description of the custom cipher group.
  - c) In the **Cipher Suites** section, click **Add** and select the ciphers to include in the list of supported SSL ciphers.
  - d) Click **Create**.

## View existing SSL cipher bindings

To view the existing cipher bindings, on the **Configuration** tab, in the navigation pane, expand **System**, and then click **Configure SSL Settings** under **System Settings**.

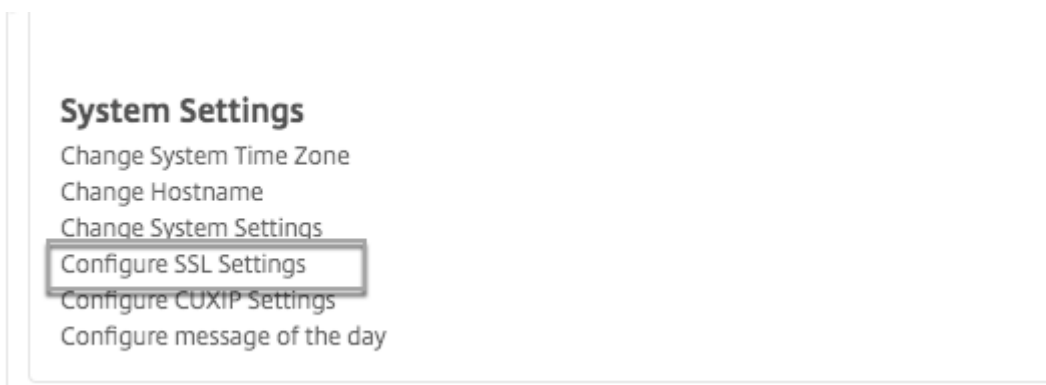

### Note:

After upgrade to the latest version of the Management Service, the list of existing cipher suites shows the OpenSSL names. Once you bind the ciphers from the upgraded Management Service,

the display uses the Citrix naming convention.

### Bind ciphers to the HTTPS service

1. On the **Configuration** tab, in the navigation pane, click **System**.
2. In the **System** pane, under System Settings, click **Configure SSL Settings**.
3. In the **Edit Settings** pane, click **Ciphers Suites**.
4. In the **Ciphers Suites** pane, do either of the following:
  - To choose a cipher group from the predefined cipher groups, select **Cipher Groups**, select a cipher group from the **Cipher Groups** list, and then click **OK**.
  - To choose from the list of supported ciphers, select the **Cipher Suites** check box, click **Add** to select the ciphers, and then click **OK**.

## Back up and restore the configuration data of the SDX appliance

December 12, 2023

The NetScaler SDX appliance backup process is a single step process that creates a backup file containing the following:

- Single bundle image:
  - Citrix Hypervisor image
  - Hotfixes and Supplemental Packs of Citrix Hypervisor
  - Management Service image
- XVA image
- Upgrade image
- SDX configuration
- Configuration

The backup folder is `/var/mps/backup/`.

### Back up the current configuration

1. On the **Configuration** tab, in the navigation pane, expand **Management Service**, and then click **Backup Files**.
2. In the **Backup Files** pane, click **Back Up**.

3. In the **New Backup File** dialog box, select the **Password Protect file** check box to encrypt the backup file.
4. In the **Password** and **Confirm Password** fields, type and confirm the password for the backup file.
5. Click **Continue**.

The backup process creates a backup file. The file name of the backup file includes the current IP address of the Management Service and the timestamp when the backup was taken. To check for any discrepancy that the backup file might have, from the SDX GUI navigate to **Configuration > System > Events/Alarms**.

## Scheduled backup

By default, SDX creates a backup every 24 hours using a backup policy. Using the backup policy, you can define the number of backup files that you want to retain in the SDX appliance. Also, you can encrypt the scheduled backup files using a password to ensure that the backup file is secure.

### Edit the backup policy

1. On the **Configuration** tab, click **System**.
2. In the **Policy Administration** pane, click **Backup Policy**.
3. In the **Configure backup policy** pane, perform the following:
  - a) In the **Previous backups to retain** field, type the number of backup files you want to retain.
  - b) To encrypt the backup files, select **Encrypt Backup File** check box.
  - c) In the **Password** and **Confirm Password** fields, type and confirm the password to encrypt the backup file.

### Manually transfer the backup file to an external backup server

Ensure that you have the external backup server details before you manually transfer the backup file.

### Transfer the backup file to an external backup server

1. On the **Configuration** tab, in the navigation pane, expand **Management Service**, and then click **Backup Files**.
2. In the **Backup Files** pane, select the backup file and then click **Transfer**.

3. In the **Server** field, type the host name or IP address of the external backup server.
4. In the **User Name** and **Password** fields, type the user name and password to access the external backup server.
5. In the **Port** field, type the port number.
6. In the **Transfer Protocol** field, select the protocol you want to use to transfer the backup file to the external backup server.
7. In the **Directory Path** field, type the path of the directory in the external backup server where you want to store the backup files.
8. Select **Delete file from Management Service** to delete the backup file from the SDX appliance after you have transferred the backup file to the external backup server.
9. Click **OK**.

## Restore the appliance

You can restore the SDX appliance to the configuration available in the backup file. During the appliance restore, all the current configuration is deleted.

### Points to note:

- Before you restore the SDX appliance using the backup file of a different SDX appliance, add the Management Service network settings according to the settings available in the backup file.
- Ensure that the platform variant on which the backup was taken is the same as on which you are trying to restore. Restoring the backup file between two different platform variants is not supported.
- Citrix recommends restoring SDX backup only after the network configuration is set. You can specify the following network settings for the SVM:
  - SVM IP address
  - Hypervisor IP address
  - Subnet mask
  - Gateway
  - DNS server

## Restore the appliance from the backup file

1. On the **Configuration** tab, in the navigation pane, expand **Management Service**, and then click **Backup Files**.
2. In the **Backup Files** pane, click the backup file and then click **OK**.
3. In the **Restore** dialog box, select **Appliance Restore**, and then click **Proceed**.

The different components of the application restore are displayed:

- License
- SDX Image
- XVA Files
- NetScaler configuration
- Summary

If any of the required components are missing in the backup file, you're prompted to upload the missing element before proceeding further.

To know whether a backup file can be restored on the current SDX Single Bundle Image Version, see the following table. As a thumb rule for Single Bundle Image, any lower version backup cannot be restored on a later version.

Current SDX Single Bundle Image Version	Backup File Version
11.1	11.1, 12.0, 12.1, 13.0 supported; 11.0 not supported
12.0	12.0, 12.1, 13.0 supported; 11.0 and 11.1 not supported
12.1	12.1, 13.0 supported, 11.0, 11.1, 12.0 not supported
13.0	13.0 supported; 11.0, 11.1, 12.0, 12.1 not supported
13.1	13.1 supported; 11.0, 11.1, 12.0, 12.1, 13.0 not supported

4. On the **License** page, check that a valid license is present and click **Next**.
5. The **SDX Image** page appears. If an SDX image is not required to perform the restore, click **Next**. Otherwise, when prompted upload a valid SDX image and click **Next**.
6. The **XVA File** page opens. Click **Next** if XVA images for all instances are present. If the XVA file for any instance is missing in the backup file, you can either upload it or skip restoring this instance. Click **Next** to go to the next page.
7. The NetScaler Configuration page opens. NetScaler configuration files are not mandatory. You can provision the instance without restoring its configuration. If the NetScaler configuration file is missing in the backup file, you can either proceed only with instance provisioning or skip restoring the instance. Click **Next** to go to the next page.
8. The summary page appears with the following details about all the instances present in the backup file:
  - IP address

- Host name
  - SDX version
  - XVA version
  - Version bit
  - Restore: if the appliance or instance is ready for restore, a check mark appears. If it's not, a cross mark appears.
  - Error messages: if the appliance or instance is not ready for restore, an error message appears to explain the reason.
9. Click **Restore** to complete the application restore process.

### Restore the NetScaler instance

You can restore the NetScaler instance in the SDX appliance to the NetScaler instances that are available in the backup file.

**Point to note:** A VPX instance fails to restore if:

- The instance does not have a management NIC assigned to it, and
  - The instance is managed from the SDX Management Service only through LACP.
- The restore fails because SDX Management Service cannot restore the channel configurations automatically. To avoid this issue, manually restore the channel configuration to complete the VPX instance restore.

#### To restore the NetScaler instance in the backup file:

1. On the **Configuration** tab, in the navigation pane, expand **Management Service**, and then click **Backup Files**.
2. In the **Backup Files** pane, select the backup file and then click **Restore**.
3. In the **Restore** dialog box, select **Instance Restore**.
4. Select the NetScaler instances that you want to restore and then click **Proceed**.
5. (Optional) If the backup file is encrypted, when prompted, type the password and then click **OK**.

#### Note:

Ensure that an appropriate XVA, build image, and channel configuration are present on the SDX appliance that runs the instance that is being restored.

## Perform an appliance reset

August 1, 2023

The NetScaler SDX appliance allows you to:

- Reset the configuration of the appliance.

**Note:**

When you reset the configuration, you must log on using the appliance serial number as the password.

- Reset the appliance to factory version.
- Reset the appliance to a particular Single Bundle Image version.

Before performing an appliance reset, back up all the data stored on the appliance, including the settings of all the NetScaler instances provisioned on the appliance.

Citrix recommends that you store the files outside the appliance. Performing an appliance reset terminates all current client sessions with the Management Service. Log back on to the Management Service for any additional configuration tasks. When you are ready to restore the data, import the backup files by using the Management Service.

The Management Service provides the following options to reset the Appliance:

- Config Reset
- Factory Reset
- Clean Install

## **Reset the configuration of the appliance**

The Management Service provides the Config Reset option to reset the configuration of the Appliance. The Config Reset option performs the following:

- Deletes VPX instances.
- Deletes SSL certificate and key files.
- Deletes license and technical archive files.
- Deletes the NTP configuration on the appliance.
- Restores the time zone to UTC.
- Restores prune and backup policies to their default settings.
- Deletes the Management Service image.
- Deletes the NetScaler SDX image.
- Deletes all XVA images except the last image file that was accessed on the appliance.
- Restores default interface settings.
- Restores the default configuration of the appliance, including default profiles, users, and system settings.

- Restores default passwords for Citrix Hypervisor and the Management Service.
- Restarts the Management Service.

### Reset the configuration of the appliance

1. Navigate to **Configuration > System > System Administration group**.
2. Click **Appliance Reset**.
3. In the **Appliance Reset** dialog box, select **Config Reset** in the **Reset Type** list.
4. Click **OK**.

### Reset the appliance to factory version

The Management Service provides the Factory Reset option to reset the appliance to the factory version. The Factory Reset option resets the current IP addresses of the Management Service and Citrix Hypervisor to the default IP addresses of the Management Service and Citrix Hypervisor.

Ensure that you back up all the data stored on the appliance, including the settings of all the NetScaler instances provisioned on the appliance. Citrix recommends that you store the files outside the appliance. Performing a factory reset terminates all current client sessions with the Management Service. Log back on to the Management Service for any additional configuration tasks. When you are ready to restore the data, import the backup files by using the Management Service.

#### Important

Make sure you connect a serial console cable to the appliance before performing a factory reset.

### Reset the appliance to the factory version

1. Navigate to **Configuration > System > System Administration**.
2. Click **Appliance Reset**.
3. In the **Appliance Reset** dialog box, select **Factory Reset** in the **Reset Type** list.
4. Click **OK**.

### Reset the appliance to a single bundle image version

The Management Service provides the Clean Install option that allows you to install an arbitrary version of a single bundle image on the appliance. It enables you to perform a fresh install of the single bundle image as the new default boot image. Clean installation removes the existing configuration, except network settings, in the SDX appliance.



**Note:**

If your SDX appliance was shipped with software version 11.0 or earlier, clean install to version 13.1 or later fails.

The clean-install option is supported on the following:

Single Bundle Image Version	SDX Platforms
11.0.xx	SDX 14xxx, SDX 25xxx. <b>Note:</b> The clean-install option is supported on other SDX platforms if they have a 10G factory partition.
11.1.xx	SDX 14xxx, SDX 25xxx. <b>Note:</b> The clean-install option is supported on other SDX platforms if they have 10G factory partition
11.1.51.x	All the SDX platforms.
12.1.xx	All the SDX platforms.
13.0.xx	All the SDX platforms.
13.1.xx	All the SDX platforms.

**Prerequisites**

Make sure that:

- You fail over all the primary high availability nodes to a different SDX appliance. If you do not have high availability capabilities, make sure that you plan for the downtime accordingly.
- Download the single bundle image to your local machine.

**Important:**

Make sure that you do not restart or power cycle the appliance while using the Clean Install option.

The appliance is restarted multiple times.

**Reset the appliance to a single bundle image version**

1. Navigate to **Configuration > System > System Administration** group.
2. Click **Appliance Reset**.
3. In the **Appliance Reset** dialog box, select **Clean Install** in the **Reset Type** list.
4. Click **OK**.

## Cascading external authentication servers

December 12, 2023

Cascading multiple external authentication servers provides a continuous, reliable process for authenticating and authorizing external users. If authentication fails on the first authentication server, the Management Service attempts to authenticate the user by using the second external authentication server.

To enable cascading authentication, add the external authentication servers to the Management Service. For more information, see [Configuring External Authentication](#). You can add any type of the supported external authentication servers (RADIUS, LDAP, and TACACS). For example, to add four external authentication servers for cascading authentication, you can add any combination of RADIUS, LDAP, and TACACS servers. You can also add all four servers of the same type. You can configure up to 32 external authentication servers in NetScaler Application Delivery Management.

### Cascade external authentication servers

1. On the **Configuration** tab, under **System**, expand **Authentication**.
2. In the **Authentication** page, click **Authentication Configuration**.
3. In the **Authentication Configuration** page, select **EXTERNAL** from the **Server Type** drop-down list (you can cascade only external servers).
4. Click **Insert**, and on the **External Servers** page that opens, select one or multiple authentication servers that you would like to cascade.
5. Click **OK**.

The selected servers are displayed on the **Authentication Servers** page as shown in the following figure. To change the order of authentication, use the icon next to a server name to move the server up or down in the list.

## ← Authentication Configuration

The appliance can authenticate users with local user accounts or by using an external authentication server.

Server Type\*

EXTERNAL

External Servers

Insert Delete

<input checked="" type="checkbox"/>	Server Type	Server Name
<input checked="" type="checkbox"/>	RADIUS	10.102.166.80
<input checked="" type="checkbox"/>	LDAP	_LDAP2
<input checked="" type="checkbox"/>	LDAP	_LDAP1

Enable fallback local authentication

OK Close

## Unlock a user

August 1, 2023

A NetScaler SDX admin can unlock a user before the lockout interval expires. Lockout is not applicable if a user logs in to the Management Service via the console. The lockout interval is also changed from seconds to minutes. Minimum value = 1 minute. Maximum value = 30 minutes.

### Unlock a user using the GUI

1. Navigate to **Configuration > System > User Administration > Users**.
2. Select the user to unlock.
3. Click **Unlock**.

### Unlock a user using the CLI

At the command prompt, type:

```
set systemuser id=<ID> unlock=true
```

## Provision NetScaler instances

October 6, 2023

### Note

The NetScaler Console service connect is enabled by default, after you install or upgrade the NetScaler SDX appliance to release 13.1. For more details, see [Data governance and NetScaler Console service connect](#).

You can provision one or more NetScaler instances on the SDX appliance by using the Management Service. The number of instances that you can install depends on the license you have purchased. If the number of instances added is equal to the number specified in the license, the Management Service does not allow provisioning more NetScaler instances.

### Note:

You can configure up to 20 VPX instances on a network interface independent of the underlying hardware platform.

Provisioning a NetScaler VPX instance on the SDX appliance comprises the following steps.

1. Define an admin profile to attach to the NetScaler instance. This profile specifies the user credentials that are used by the Management Service to provision the ADC instance and later, to communicate with the instance to retrieve configuration data. You can also use the default admin profile.
2. Upload the .xva image file to the Management Service.
3. Add a NetScaler instance using the Provision NetScaler wizard in the Management Service. The Management Service implicitly deploys the NetScaler instance on the SDX appliance and then downloads configuration details of the instance.

### Warning

Make sure that you modify the provisioned network interfaces or VLANs of an instance using the Management Service instead of performing the modifications directly on the instance.

## Create an admin profile

Admin profiles specify the user credentials that are used by the Management Service when provisioning the NetScaler instances. These credentials are later used when communicating with the instances to retrieve configuration data. The user credentials specified in an admin profile are also used by the client when logging on to the NetScaler instances through the CLI or GUI.

Admin profiles also enable you to specify that the Management Service and a VPX instance communicate with each other only over a secure channel or using HTTP.

The default admin profile for an instance specifies the default admin user name. This profile cannot be modified or deleted. However, you must override the default profile by creating a user-defined admin profile and attaching it to the instance when you provision the instance. The Management Service administrator can delete a user-defined admin profile if it is not attached to any NetScaler instance.

#### **Important**

Do not change the password directly on the VPX instance. If you do so, the instance becomes unreachable from the Management Service. To change a password, first create an admin profile, and then modify the NetScaler instance, selecting this profile from the Admin Profile list.

To change the password of NetScaler instances in a high availability setup, first change the password on the instance designated as the secondary node. Then change the password on the instance designated as the primary node. Remember to change the passwords only by using the Management Service.

#### **Create an admin profile**

1. On the **Configuration** tab, in the navigation pane, expand **NetScaler Configuration**, and then click **Admin Profiles**.
2. In the **Admin Profiles** pane, click **Add**.
3. The **Create Admin Profile** dialog box appears.

## ← Create Citrix ADC Profile

Profile Name\*  
 X Please enter value

User Name

Password\*

Use global settings for Citrix ADC communication

▼ SNMP

Version  
 v2  v3

Security Name\*

Security Level\*  
 ▼

▼ Timeout Settings

commandcenter.timeout\_settings

Timeout (in Seconds)

Set the following parameters:

- Profile Name: name of the admin profile. The default profile name is `nsroot`. You can create user-defined profile names.
- Password: the password used to log on to the NetScaler instance. Maximum length: 31 characters.
- SSH Port: set the SSH port. The default port is 22.

- **Use global settings for NetScaler communication:** Select if you want the setting to be defined in the System Settings for the communication between the Management Service and the NetScaler instance. You can clear this box and change the protocol to HTTP or HTTPS.
    - Select the **http** option to use HTTP protocol for the communication between the Management Service and the NetScaler instance.
    - Select the **https** option to use the secure channel for the communication between the Management Service and the NetScaler instance.
4. Under **SNMP**, select the version. If you select v2, go to step 5. If you select v3, go to step 6.
  5. Under SNMP v2, add the SNMP **Community** name.
  6. Under SNMP v3, add **Security Name** and **Security Level**.
  7. Under **Timeout Settings**, specify the value.
  8. Click **Create**, and then click **Close**. The admin profile that you created appears in the **Admin Profiles** pane.

If the value in the **Default** column is true the default profile is the admin profile. If the value is false, a user-defined profile is the admin profile.

If you do not want to use a user-defined admin profile, you can remove it from the Management Service. To remove a user-defined admin profile, in the **Admin Profiles** pane, select the profile you want to remove, and then click **Delete**.

## Upload a NetScaler .xva image

A .xva file is required for adding a NetScaler VPX instance.

Upload the NetScaler SDX .xva files to the SDX appliance before provisioning the VPX instances. You can also download a .xva image file to a local computer as a backup. The .xva image file format is: `NSVPX-XEN-ReleaseNumber-BuildNumber_nc.xva`.

In the **NetScaler XVA Files** pane, you can view the following details.

- **Name:** Name of the .xva image file. The file name contains the release and the build number. For example, the file name `NSVPX-XEN-12.1-56.22.xva.gz` refers to release 12.1 build 56.22.
- **Last Modified:** Date when the .xva image file was last modified.
- **Size:** Size, in MB, of the .xva image file.

### To upload a NetScaler .xva file

1. On the **Configuration** tab, in the navigation pane, expand **NetScaler Configuration**, and then click **XVA Files**.
2. In the **NetScaler XVA Files** pane, click **Upload**.
3. In the **Upload NetScaler instance XVA** dialog box, click **Browse** and select the XVA image file that you want to upload.
4. Click **Upload**. The XVA image file appears in the **NetScaler XVA Files** pane after it is uploaded.

### To create a backup by downloading a NetScaler .xva file

1. In the **NetScaler Build Files** pane, select the file that you want to download, and then click **Download**.
2. In the **File Download** message box, click **Save**.
3. In the **Save As** message box, browse to the location where you want to save the file, and then click **Save**.

### Add a NetScaler instance

When you add NetScaler instances from the Management Service, you need to provide values for some parameters. The Management Service implicitly configures these settings on the NetScaler instances.



## ← Provision Citrix ADC

Name\*

 ⓘ × Please enter value

Manage through internal network

IPv4

IPv6

XVA File\*

Choose File

Admin Profile\*

ns\_nsroot\_profile

Description

- **Name:** Assign a name to the NetScaler instance.
- Select **Manage through internal network** to enable an independent internal always-on connectivity between the SDX Management Service and the VPX instance. This feature is supported in 13.0-36.27 and higher version of VPX instances running on the SDX appliance.
- Select an IPv4 or IPv6 address or both IPv4 and IPv6 addresses to access the NetScaler VPX instance for the management purpose. A NetScaler instance can have only one management IP (NSIP). You cannot remove an NSIP address.
- Assign a netmask, default gateway, and next hop to Management Service for the IP address.
- The **Gateway** and **Nexthop to Management Service** fields are optional under either of the following conditions, when VPX is provisioned with version 13.0–88.9 or 13.1–37.8, and their higher versions:
  - When **Manage through internal network** is enabled.
  - When the configured IPv4 address is in the same subnet as the Management Service IP address.

IPv4

IPv4 Address\*

Netmask\*

Gateway

Nexthop to Management Service

Next, add the XVA file, Admin Profile, and a description for the instance.

**Note:** For a high availability setup (active-active or active-standby), Citrix recommends that you configure the two NetScaler VPX instances on different SDX appliances. Make sure that the instances in the setup have identical resources, such as CPU, memory, interfaces, packets per second (PPS), and throughput.

### License allocation

In this section, specify the license you have procured for the NetScaler. The license can be Standard, Enterprise, and Platinum.

**Note:** An asterisk indicates required fields.

License Allocation			
Feature License*		For more information about Citrix ADC editions, see Citrix ADC Editions	
Standard			
Pool	Total	Available	Allocate
Instance	0	0	1
Bandwidth			Allocation Mode* Fixed
	0 Gbps	0 Gbps	Throughput (Mbps)* 1000

If you need bandwidth-bursting ability, select **Burstable** under **Allocation Mode**. For more information, see [Bandwidth Metering in SDX](#).

### Crypto allocation

Starting with release 12.1 48.13, the interface to manage crypto capacity has changed. For more information, see [Manage crypto capacity](#).

## Resource allocation

Under resource allocation, assign total memory, packets per second, and CPU.

**Resource Allocation**

Total Memory (MB)\*

Packets per second\*

CPU\*

### CPU

Assign a dedicated core or cores to the instance, or the instance shares a core with other instances. If you select shared, then one core is assigned to the instance but the core might be shared with other instances if there is a shortage of resources. Reboot affected Instances if CPU cores are reassigned. Restart the instances on which CPU cores are reassigned to avoid any performance degradation.

From SDX release 11.1.x.x (MR4), if you are using the SDX 2500xx platform, you can assign a maximum of 16 cores to an instance. Also, if you are using the SDX 2500xxx platform, you can assign a maximum of 11 cores to an instance.

**Note:** For an instance, the maximum throughput that you configure is 180 Gbps.

The following table lists the supported VPX, Single bundle image version, and the number of cores you can assign to an instance:

Platform Name	Total Cores	Total Cores Available for VPX Provisioning	Maximum Cores That Can Be Assigned to a Single Instance
SDX 8015, SDX 8400, and SDX 8600	4	3	3
SDX 8900	8	7	7
SDX 11500, SDX 13500, SDX 14500, SDX 16500, SDX 18500, and SDX 20500	12	10	5
SDX 11515, SDX 11520, SDX 11530, SDX 11540, and SDX 11542	12	10	5

Platform Name	Total Cores	Total Cores Available for VPX Provisioning	Maximum Cores That Can Be Assigned to a Single Instance
SDX 17500, SDX 19500, and SDX 21500	12	10	5
SDX 17550, SDX 19550, SDX 20550, and SDX 21550	12	10	5
SDX 14020, SDX 14030, SDX 14040, SDX 14060, SDX 14080, and SDX 14100	12	10	5
SDX 22040, SDX 22060, SDX 22080, SDX 22100, and SDX 22120	16	14	7
SDX 24100 and SDX 24150	16	14	7
SDX 14020 40G, SDX 14030 40G, SDX 14040 40G, SDX 14060 40G, SDX 14080 40G, and SDX 14100 40G	12	10	10
SDX 14020 FIPS, SDX 14030 FIPS, SDX 14040 FIPS, SDX 14060 FIPS, SDX 14080 FIPS, and SDX 14100 FIPS	12	10	5
SDX 14040 40S, SDX 14060 40S, SDX 14080 40S, and SDX 14100 40S	12	10	10
SDX 25100A, 25160A, 25200A	20	18	9
SDX 25100-40G, 25160-40G, 25200-40G	20	18	16 (if version is 11.1-51.x or higher); 9 (if version is 11.1-50.x or lower; all versions of 11.0 and 10.5)
SDX 26100, 26160, 26200, 26250	28	26	16

Platform Name	Total Cores	Total Cores Available for VPX Provisioning	Maximum Cores That Can Be Assigned to a Single Instance
SDX 26100-50S, 26160-50S, 26200-50S, 26250-50S	28	26	16
SDX 26100-100G, 26160-100G, 26200-100G, 26250-100G	28	26	25
SDX 15000	16	14	14
SDX 15000-50G	16	14	14
SDX 9100	10	9	9
SDX 16000	32	30	16

**Note:**

Dedicated cores map to the number of packet engines running on the instance. For a VPX instance created with dedicated cores, an additional CPU is assigned for management.

**Instance administration**

You can create an admin user for the VPX instance by selecting **Add Instance Administration** under **Instance Administration**.

**Instance Administration**

Add Instance Administration

User Name\*

Password\*

Confirm Password\*

Shell/SFTP/SCP Access

Add the following details:

**User name:** The user name for the NetScaler instance administrator. This user has superuser access but does not have access to networking commands to configure VLANs and interfaces.

**Password:** The password for the user name.

**Shell/Sftp/Scp Access:** The access allowed to the NetScaler instance administrator. This option is selected by default.

### Network settings

- **Allow L2 Mode:** You can allow L2 mode on the NetScaler instance. Select **Allow L2 Mode** under **Networking Settings**. Before you log on to the instance and enable L2 mode. For more information, see [Allowing L2 Mode on a NetScaler instance](#).

**Network Settings**

Allow L2 Mode ?

0/1 VLAN Tag

0/2 VLAN Tag

**Data Interfaces**

	Interface	Allow Untagged Traffic	Allowed VLANs
No items			

**Note:**

- If you disable L2 mode for an instance from the Management Service, you must log on to the instance and disable L2 mode from that instance. Failure to do so might cause all the other NetScaler modes to be disabled after you restart the instance
- After an ADC instance is provisioned on SDX, you cannot delete an interface or channel from the ADC instance. However, you can add an interface or channel to the ADC instance.

- **Interface 0/1 and 0/2:** By default, interface 0/1 and 0/2 are selected for management LA.
- **VLAN tag:** Specify a VLAN ID for the management interface. Next, add data interfaces.

**Note:**

The interface IDs of interfaces that you add to an instance do not necessarily correspond to the physical interface numbering on the SDX appliance. If the first interface that you associate with instance 1 is interface 1/4, it appears as interface 1/1 when you view the interface settings on the instance. The numbering changes because it is the first interface

that you associated with instance 1.

## Add Data Interface

Interfaces\*

1/4

Allow Untagged Traffic

Allowed VLANs

100-110,142,151-155

MAC Address Mode\*

Default

### ▼ VMAC Settings (IPv4 and IPv6 VRIDs to configure Virtual MAC)

VRID IPv4

100-110,142,151-155

VRID IPv6

100-110,142,151-155

Add

Close

- **Allow untagged traffic:** Select the **Allow untagged traffic** check box to enable the NetScaler instance to process the untagged traffic.

#### Note:

When the SDX appliance version is 13.1-24.x or later and the NetScaler instance version is earlier than 13.1-24.x, the ADC instance processes the untagged traffic on the Mellanox interfaces even if the **Allow untagged traffic** check box is cleared.

- **Allowed VLANs:** Specify a list of VLAN IDs that can be associated with a NetScaler instance.
- **MAC Address Mode:** Assign a MAC address. Select from one of the following options:
  - **Default:** Citrix Hypervisor assigns a MAC address.
  - **Custom:** Choose this mode to specify a MAC address that overrides the generated MAC address.

- **Generated:** Generate a MAC address by using the base MAC address set earlier. For information about setting a base MAC address, see [Assigning a MAC Address to an Interface](#).
- VMAC Settings (IPv4 and IPv6 VRIDs to configure Virtual MAC)
  - **VRID IPV4:** The IPv4 VRID that identifies the VMAC. Possible values: 1–255. For more information, see [Configuring VMACs on an Interface](#).
  - **VRID IPV6:** The IPv6 VRID that identifies the VMAC. Possible values: 1–255. For more information, see [Configuring VMACs on an Interface](#).

### Management VLAN settings

Typically, the Management Service and the management address (NSIP) of the VPX instance are in the same subnetwork, and communication is over a management interface. However, if the Management Service and the instance are in different subnetworks, you have to specify a VLAN ID at the time of provisioning a VPX instance. This ID is required so that the instance can be reached over the network when it starts. If your deployment requires that the NSIP is accessible only by the interface selected at the time of provisioning the VPX instance, select the NSVLAN option.

If **NSVLAN** option is selected, you cannot change this setting after you have provisioned the NetScaler instance.



### Management VLAN Settings

VLAN for Management Traffic

**L2VLAN**

When this option is selected, the configured VLAN is created as a data VLAN on NetScaler instance, and is used by the Management Service to access the NSIP for all communication with the instance. This option is suitable for performing in-band management of the instance over the data VLAN, without creating a separate management network.

**NSVLAN**

When this option is selected, the configured VLAN is created as the NSVLAN on NetScaler instance, and is used by the Management Service to access the NSIP for all communication with the instance. This option is suitable for performing out-of-band management of the instance over a separate management network. i.e., the NSVLAN.

Tagall

Interfaces

Configured (0) Remove All

No items

**Note:**

- HA heartbeats are sent only on the interfaces that are part of the NSVLAN.
- You can configure an NSVLAN only from VPX XVA build 9.3 53.4 and later.

**Important:** If NSVLAN is not selected, running the “clear config full” command on the VPX instance deletes the VLAN configuration.

Click **Done** to provision the NetScaler VPX appliance.

## Modify a NetScaler instance

To modify the parameter values of a provisioned ADC instance, in the **NetScaler instances** pane, select the instance that you want to modify, and then click **Modify**. In the Modify ADC Wizard, modify the parameters.

### Points to note:

- If you modify the following parameters: number of SSL chips, interfaces, memory, and feature license, the NetScaler instance implicitly stops and restarts to bring these parameters into effect.
- You cannot modify the Image and User Name parameters.
- Interfaces or channels cannot be deleted from the ADC instance. However, new interfaces or channels can be added to the ADC instance.
- To remove an ADC instance provisioned on the SDX appliance, in the **NetScaler instances** pane, select the instance that you want to remove, and then click **Delete**. In the **Confirm** message box, click **Yes** to remove the NetScaler instance.

## Restrict VLANs to specific virtual interfaces

The SDX appliance administrator can enforce specific 802.1Q VLANs on the virtual interfaces associated with NetScaler instances. This capability is especially helpful in restricting the usage of 802.1Q VLANs by the instance administrators. If two instances belonging to two different companies are hosted on an SDX appliance, you can restrict the two companies from using the same VLAN ID. By doing so, one company does not see the other company's traffic. If an instance administrator tries to assign an interface to an 802.1Q VLAN, a validation is performed to verify that the VLAN ID specified is part of the allowed list.

By default, any VLAN ID can be used on an interface. To restrict the tagged VLANs on an interface, specify the VLAN IDs in the Network Settings at the time of provisioning a NetScaler instance. You can also specify it later by modifying the instance. To specify a range, separate the IDs with a hyphen (for example 10–12). If you initially specify some VLAN IDs but later delete all of them from the allowed list, you can use any VLAN ID on that interface. In effect, you have restored the default setting.

After creating a list of allowed VLANs, the SDX administrator does not have to log on to an instance to create the VLANs. The administrator can add and delete VLANs for specific instances from the Management Service.

**Important:** If L2 mode is enabled, the administrator must take care that the VLAN IDs on different NetScaler instances do not overlap.

**To specify the permitted VLAN IDs**

1. In the Provision ADC Wizard or the Modify ADC Wizard, on the Network Settings page, in **Allowed VLANs**, specify one or more VLAN IDs allowed on this interface. Use a hyphen to specify a range. For example, 2–4094.
2. Follow the instructions in the wizard.
3. Click **Finish**, and then click **Close**.

**To configure VLANs for an instance from the Management Service**

1. On the **Configuration** tab, navigate to NetScaler > Instances.
2. Select an instance, and then click **VLAN**.
3. In the details pane, click **Add**.
4. In the **Create NetScaler VLAN** dialog box, specify the following parameters:
  - **VLAN ID**—An integer that uniquely identifies the VLAN to which a particular frame belongs. The NetScaler supports a maximum of 4094 VLANs. ID 1 is reserved for the default VLAN.
  - **IPv6 Dynamic Routing**—Enable all IPv6 dynamic routing protocols on this VLAN. Note: For the **ENABLED** setting to work, you must log on to the instance and configure IPv6 dynamic routing protocols from the VTYSH command line.
5. Select the interfaces that must be part of the VLAN.
6. Click **Create**, and then click **Close**.

## Manage crypto capacity

October 6, 2023

Starting with release 12.1 48.13, the interface to manage crypto capacity has changed. The Management Service provides asymmetric crypto units (ACUs), symmetric crypto units (SCUs), and crypto virtual interfaces to denote SSL capacity on the NetScaler SDX appliance. Earlier crypto capacity was assigned in units of SSL chips, SSL cores, and SSL virtual functions. See the Legacy SSL chips to ACU and SCU conversion table for more information about how legacy SSL chips translate into ACU and SCU units.

By using the Management Service GUI, you can allocate crypto capacity to the NetScaler VPX instance in units of ACU and SCU.

The following table provides brief descriptions about ACUs, SCUs, and crypto virtual instances.

**Table.** Unit crypto units

New crypto units	Description
Asymmetric crypto unit (ACU)	1 ACU = 1 operation per second (ops) of (RSA) 2 K (2048-bit key size) decryption. For further details, see ACU to PKE resource conversion table.
Symmetric crypto unit (SCU)	1 SCU = 1 Mbps of AES-128-CBC + SHA256-HMAC @ 1024B. This definition is applicable for all SDX platforms.
Crypto virtual interfaces	Also known as virtual functions, crypto virtual interfaces represent the basic unit of the SSL hardware. After these interfaces are exhausted, the SSL hardware cannot be further assigned to a VPX instance. Crypto virtual interfaces are read-only entities, and the SDX appliance automatically allocates these entities.

### View crypto capacity of the SDX appliance

You can view the crypto capacity of the SDX appliance in the dashboard of the SDX GUI. The dashboard displays the used and available ACUs, SCUs, and virtual interfaces on the SDX appliance. To view the crypto capacity, navigate to **Dashboard > Crypto Capacity**.

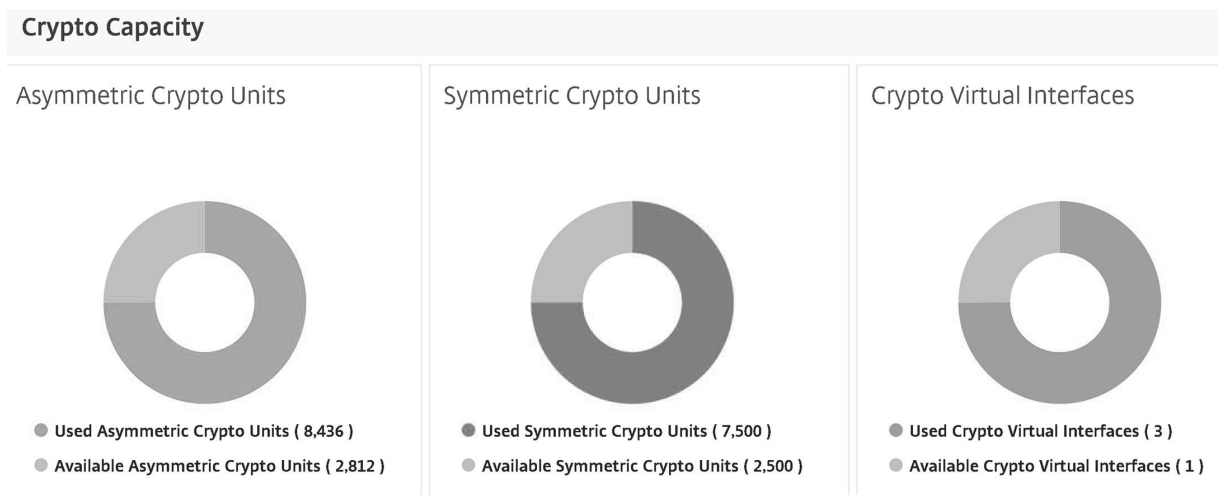

### Allocate crypto capacity while provisioning the VPX instance

While provisioning a VPX instance on the SDX appliance, under **Crypto Allocation**, you can allocate the number of ACUs and SCUs for the VPX instance. For instructions to provision a VPX instance, see [Provisioning NetScaler instances](#).

To allocate crypto capacity while provisioning a VPX instance, follow these steps.

1. Log on to the Management Service.
2. Navigate to **Configuration > NetScaler > Instances**, and click **Add**.
3. Under **Crypto Allocation**, you can view the available ACUs, SCU, and crypto virtual interfaces. The way to allocate ACUs and SCUs differs depending on the SDX appliance:
  - a. For the appliances listed in the Minimum value of an ACU counter available for different SDX appliances, you can assign ACUs in multiples of a specified number. SCUs are automatically allocated and the SCU allocation field is not editable. You can increase ACU allocation in the multiples of the minimum ACU available for that model. For example, if the minimum ACU is 4375, the ACU increment is 8750, 13125, and so on.

**Example.** Crypto allocation where SCUs are automatically assigned, and ACUs are assigned in multiples of a specified number.

Crypto Allocation			
	Asymmetric Crypto Units	Symmetric Crypto Units	Crypto Virtual Interfaces
Available	70000	56000	16
Total	70000	56000	16

Asymmetric Crypto Units	4375
Symmetric Crypto Units	3500

### Minimum value of an ACU counter available for different SDX appliances

SDX platform	ACU counter minimum value
22040, 22060, 22080, 22100, 22120, 24100, 24150 (36 ports)	2187
8400, 8600, 8010, 8015	2812
17500, 19500, 21500	2812
17550, 19550, 20550, 21550	2812
11500, 13500, 14500, 16500, 18500, 20500	2812
11515, 11520, 11530, 11540, 11542	4375
14xxx	4375
14xxx 40S	4375
14xxx 40G	4375
14xxx FIPS	4375

SDX platform	ACU counter minimum value
25xxx	4375
25xxx A	4575

b. For the rest of the SDX platforms, which are not listed in the preceding table, you can freely assign ACUs and SCUs. The SDX appliance automatically allocates crypto virtual interfaces.

**Example.** Crypto allocation where both ACU and SCUs are freely assigned

Crypto Allocation			
	Asymmetric Crypto Units	Symmetric Crypto Units	Crypto Virtual Interfaces
Available	39000	41000	32
Total	39000	41000	32
Asymmetric Crypto Units			
	<input type="text" value="2000"/>		
Symmetric Crypto Units			
	<input type="text" value="2000"/>		

4./ Complete all the steps for provisioning the VPX instance, and click **Done**. For more information, see [Provisioning NetScaler instances](#).

### View crypto hardware health

In Management Service, you can view the health of the crypto hardware provided with the SDX appliance. The health of the crypto hardware is represented as Crypto Devices and Crypto Virtual Functions. To view the health of the crypto hardware, navigate to **Dashboard > Resources**.

Name	Status	Current Value	Expected Value
CPUs	● Ok	1	1
Hyper-threads	● Ok	16	16
Memory	● Ok	32 GB	32 GB
Crypto Virtual Functions	● Ok	32	32
Crypto Devices	● Ok	1	1
Management Interfaces	● Ok	1	1
10G Interfaces	● Ok	4	4
1G Interfaces	● Ok	6	6
40G Interfaces	● Ok	0	0
Disks	● Ok	1	1

**Points to note**

Keep the following points in mind when you upgrade the SDX appliance to the latest version.

- Only the SDX user interface gets upgraded, but the hardware capacity of the appliance remains the same.
- The crypto allocation mechanism remains the same, and only the representation on the SDX GUI changes.
- Crypto interface is backward compatible, and it does not affect any existing automation mechanism that uses the NITRO interface to manage the SDX appliance.
- Upon SDX appliance upgrade, the crypto assigned to the existing VPX instances does not change; only its representation on the Management Service changes.

**ACU to PKE resource conversion table**

SDX platform	ACU	RSA-RSA1K	RSA-RSA2K	RSA-RSA4K	ECDHE-RSA	ECDHE-ECDSA
22040, 22060, 22080, 22100, 22120, 24100, 24150 (36 ports)	2187	12497	2187	312	256	190
8400, 8600, 8010, 8015	2812	17000	2812	424	330	N/A
11515, 11520, 11530, 11540, 11542	4375	25000	4375	625	512	381
22040, 22060, 22080, 22100, 22120 (24 ports)	4375	25000	4375	625	512	381

SDX platform	ACU	RSA-RSA1K	RSA-RSA2K	RSA-RSA4K	ECDHE-RSA	ECDHE-ECDSA
17500, 19500, 21500	2812	17000	2812	424	330	N/A
17550, 19550, 20550, 21550	2812	17000	2812	424	330	N/A
11500, 13500, 14500, 16500, 18500, 20500	2812	17000	2812	424	330	N/A
14000, 14000-40G, 25000, 25000A	4375	25000	4375	625	512	381
14000 FIPS	4375	25000	4375	625	512	381
14000-40S	4375	25000	4375	625	512	381
*8900 (8910, 8920, 8930)	1000	4615	1000	136	397	494
*9100 (9110, 9120, 9130)	1000	4615	1000	136	397	494
*26000-100G (26100, 26160, 26200, and 26250)	1000	4615	1000	136	397	494
*15000	1000	4615	1000	136	397	494
*15000-50G	1000	4615	1000	136	397	494
*16000	1000	4615	1000	136	397	494
*26000-50S	1000	4615	1000	136	397	494

\*On these platforms the PKE numbers are the minimum guaranteed values.



## How to read the ACU to PKE resource conversion table

The ACU to PKE resource conversion table is based on the following points:

- Management Service helps allocate Crypto Resources to each individual VPX. Management Service cannot allocate or promise performance.
- Actual performance varies depending on packet size, cipher/Keyex/HMAC (or their variations) used, and so on

The following example helps you understand how to read and apply the ACU to the PKE resource conversion table.

**Example.** ACU to PKE resource conversion for the SDX 22040 platform

Allocation of 2187 ACUs to a VPX instance on an SDX 22040 platform allocates crypto resource equivalent to 256 ECDHE-RSA operations or 2187 RSA-2K operations and so on.

## Legacy SSL chips to ACU and SCU conversion table

For more information about how legacy SSL chips are converted to ACU and SCU, see the following table.

[ACU and SCU conversion table](#)

## Provision third-party virtual machines

August 1, 2023

### Warning:

The **Third-party Instances** support is deprecated in NetScaler SDX GUI from version 13.1 build 37.x onwards. If you still want to use the third-party instances, Citrix recommends you to do the following operations:

- Log on to the Management Service shell.
- Create a file `.thirdPartyVM` in directory `/mpsconfig`.
- Restart the Management Service by running the `svmd restart` command.

The SDX appliance supports provisioning of the following third-party virtual machines (instances):

- SECUREMATRIX GSB
- InterScan Web Security

- Websense Protector
- BlueCat DNS/DHCP Server
- CA Access Gateway
- PaloAlto VM-Series

SECUREMATRIX GSB provides a highly secure password system that eliminates the need to carry any token devices. Websense Protector provides monitoring and blocking capabilities, preventing data loss and leaks of sensitive information. BlueCat DNS/DHCP Server delivers DNS and DHCP for your network. PaloAlto VM-Series on NetScaler SDX enables consolidation of advanced security and ADC capabilities on a single platform, for secure, reliable access to applications by businesses and service-provider customers. The combination of VM-Series on NetScaler SDX also provides a complete, validated, secure ADC solution for Citrix Virtual Apps and Desktops deployments.

You can provision, monitor, manage, and troubleshoot an instance from the Management Service. All the preceding third-party instances use the `SDXTools` daemon to communicate with the Management Service. The daemon is pre-installed on the provisioned instance. You can upgrade the daemon when new versions become available.

When you configure third-party virtual machines, then SR-IOV interfaces (1/x and 10/x) that are part of a channel do not appear in the list of interfaces. The interfaces are missing because channels are not supported on third-party virtual machines.

**Note:**

The total number of instances that you can provision on an SDX appliance depends on the license installed on the appliance.

**Important:** You must upgrade your Citrix Hypervisor version to version 6.1.0 before you install any third-party instance.

## SECUREMATRIX GSB

August 1, 2023

SECUREMATRIX is a highly secure, tokenless, one-time-password (OTP) authentication solution that is easy to use and cost effective. It uses a combination of location, sequence, and image pattern from a matrix table to generate a single-use password. SECUREMATRIX GSB server with SECUREMATRIX Authentication server substantially enhances the security of VPN/SSL-VPN endpoints, cloud based applications and resources, desktop/virtual desktop login, and web applications (Reverse proxy with OTP). It provides a solution that is compatible with PCs, Virtual Desktops, tablets, and smart phones.

Using the NetScaler SDX multitenant platform architecture in a software defined network, SECUREMATRIX's strong authentication feature can be integrated with other tenants or cloud services delivered

through the NetScaler, such as Web Interface, Citrix Virtual Apps and Desktops, and many other application services that require authentication.

For more information, see [SECUREMATRIX](#).

### **Provision a SECUREMATRIX GSB instance**

SECUREMATRIX GSB requires a SECUREMATRIX Authentication server that must be configured outside the SDX appliance. Select exactly one interface and specify the network settings for only that interface.

**Note:** SR-IOV interfaces (1/x and 10/x) that are part of a channel do not appear in the list of interfaces. Channels are not supported on a SECUREMATRIX GSB instance.

Download an XVA image from the SECUREMATRIX website and upload it to the SDX appliance before you start provisioning the instance. For more information about downloading an XVA image, see the SECUREMATRIX website. Make sure that you are using Management Service build 118.7 or later on the SDX appliance.

On the **Configuration** tab, navigate to **SECUREMATRIX GSB > Software Images**.

#### **To upload an XVA image to the SDX appliance:**

1. In the details pane, under **XVA Files > Action**, click **Upload**.
2. In the dialog box that appears, click **Browse**, and then select the XVA file that you want to upload.
3. Click **Upload**. The XVA file appears in the XVA Files pane.

#### **To provision a SECUREMATRIX instance**

1. On the **Configuration** tab, navigate to **SECUREMATRIX GSB > Instances**.
2. In the details pane, click **Add**.
3. In the **Provision SECUREMATRIX GSB wizard**, follow the instructions on the screen.
4. Click **Finish**, and then click **Close**.

After provisioning the instance, log on to the instance and perform a detailed configuration. For more information, see the [SECUREMATRIX](#) website.

To modify the settings of a provisioned SECUREMATRIX instance, in the **SECUREMATRIX Instances** pane, select the instance that you want to modify, and then click **Modify**. In the Modify SECUREMATRIX GSB wizard, modify the parameters.

**Note:** If you modify any of the interface parameters or the name of the instance, the instance stops and restarts to put the changes into effect.

Generate a tar archive for submission to technical support. For information about generating a technical support file, see [Generating a Tar Archive for Technical Support](#).

Back up the configuration of a SECUREMATRIX GSB instance and later use the backup data to restore the configuration of the instance on the SDX appliance. For information about backing up and restoring an instance, see [Backing Up and Restoring the Configuration Data of the SDX Appliance](#).

### Monitor a SECUREMATRIX GSB instance

The SDX appliance collects statistics, such as the version of `SDXTools`, the states of SSH and CRON daemons, and the Webserver state, of a SECUREMATRIX GSB instance.

To view the statistics related to a SECUREMATRIX GSB instance:

1. Navigate to **SECUREMATRIX GSB > Instances**.
2. In the details pane, click the arrow next to the name of the instance.

### Manage a SECUREMATRIX GSB instance

You can start, stop, restart, force stop, or force restart a SECUREMATRIX GSB instance from the Management Service.

On the **Configuration** tab, expand **SECUREMATRIX GSB**.

#### To start, stop, restart, force stop, or force restart an instance:

1. Click **Instances**.
2. In the details pane, select the instance on which you want to perform the operation, and then select one of the following options:
  - Start
  - Shut Down
  - Reboot
  - Force Shutdown
  - Force Reboot
3. In the Confirm message box, click **Yes**.

### Upgrade the SDX tools file for a SECUREMATRIX GSB instance

`SDXTools`, a daemon running on the SECUREMATRIX GSB instance, is used for communication between the Management Service and the instance.

Upgrading **SDXTools** involves uploading the file to the SDX appliance, and then upgrading **SDXTools** after selecting an instance. You can upload an **SDXTools** file from a client computer to the SDX appliance.

**To upload an SDXTools file:**

1. In the navigation pane, expand **Management Service**, and then click **SDXTools Files**.
2. In the details pane, from the **Action** list, select **Upload**.
3. In the **Upload SDXTools Files** dialog box, click **Browse**, navigate to the folder that contains the file, and then double-click the file.
4. Click **Upload**.

**To upgrade SDXTools:**

On the **Configuration** tab, expand **SECUREMATRIX GSB**.

1. Click **Instances**.
2. In the details pane, select an instance.
3. From the **Action** list, select **Upgrade SDXTools**.
4. In the **Upgrade SDXTools** dialog box, select a file, click **OK**, and then click **Close**.

**Upgrade and downgrade a SECUREMATRIX GSB instance**

The process of upgrading the SECUREMATRIX GSB instance involves uploading the software image of the target build to the SDX appliance, and then upgrading the instance. Downgrading loads an earlier version of the instance.

On the **Configuration** tab, expand **SECUREMATRIX GSB**.

**To upload the software image:**

1. Click **Software Images**.
2. In the details pane, from the **Action** list, select **Upload**.
3. In the dialog box, click **Browse**, navigate to the folder that contains the build file, and then double-click the build file.
4. Click **Upload**.

To upgrade the instance:

1. Click **Instances**.
2. In the details pane, select an instance.
3. From the **Action** list, select **Upgrade**.
4. In the dialog box that appears, select a file, click **OK**, and then click **Close**.

To downgrade an instance:

1. Click **Instances**.
2. In the details pane, select an instance.
3. From the **Action** list, select **Downgrade**.
4. In the Confirm message box, click **Yes**.

## Troubleshoot a SECUREMATRIX GSB Instance

Ping a SECUREMATRIX GSB instance from the Management Service to check whether the device is reachable. You can trace the route of a packet from the Management Service to an instance to determine the number of hops involved in reaching the instance.

Rediscover an instance to view the latest state and configuration of an instance. During rediscovery, the Management Service fetches the configuration and the version of the SECUREMATRIX GSB running on the SDX appliance. By default, the Management Service schedules instances for rediscovery once every 30 minutes.

On the **Configuration** tab, expand **SECUREMATRIX GSB**.

### To ping an instance:

1. Click **Instances**.
2. In the details pane, select the instance that you want to ping, and from the **Action** list, click **Ping**. The Ping message box shows whether the ping is successful.

### To trace the route of an instance:

1. Click **Instances**.
2. In the details pane, select the instance for which you want to trace the route, and from the **Action** list, click **TraceRoute**. The Traceroute message box displays the route to the instance.

### To rediscover an instance:

1. Click **Instances**.
2. In the details pane, select the instance that you want to rediscover, and from the **Action** list, click **Rediscover**.
3. In the Confirm message box, click **Yes**.

## Trend Micro InterScan Web Security

August 1, 2023

Trend Micro InterScan Web Security is a software virtual appliance which dynamically protects against traditional and emerging web threats at the Internet gateway. It integrates application control, anti-malware scanning, real-time web reputation, flexible URL filtering, and advanced threat protection. As a result, it delivers superior protection and greater visibility and control over the growing use of cloud-based applications on the network. Real-time reporting and centralized management give your administrators a proactive decision making tool, enabling on the spot risk management.

InterScan Web Security:

- Allows deeper visibility into end-user Internet activity
- Centralizes management for maximum control
- Monitors web use as it happens
- Enables on-the-spot remediation
- Reduces appliance sprawl and energy costs
- Provides optional data loss protection and sandbox execution analysis

Before you can provision an InterScan Web Security instance, you must download an XVA image from the Trend Micro website. After you have downloaded the XVA image, upload it to the NetScaler SDX appliance.

**Note:** SR-IOV interfaces (1/x and 10/x) that are part of a channel do not appear in the list of interfaces. Channels are not supported on an InterScan Web Security instance.

**To upload an XVA image to the SDX appliance:**

1. From the **Configuration** tab, navigate to **TrendMicro IWSVA > Software Images**.
2. In the details pane, under **XVA Files** tab, click **Upload**.
3. In the dialog box that appears, click **Browse**, and then select the XVA file that you want to upload.
4. Click **Upload**. The XVA file appears in the XVA Files pane.

**To provision a TrendMicro IWSVA instance:**

1. On the **Configuration** tab, navigate to **TrendMicro IWSVA > Instances**.
2. In the details pane, click **Add**.
3. In the **Provision TrendMicro IWSVA** wizard, follow the instructions on the screen.
4. Click **OK**, and then click **Close**.

After you have provisioned the instance, log on to the instance and perform the detailed configuration.

To modify the values of the parameters of a provisioned instance, in the details pane, select the instance that you want to modify, and then click **Edit**. In the **Modify TrendMicro IWSVA** wizard, set the parameters to values suitable for your environment.

## Websense Protector

August 1, 2023

The Websense (now known as Forcepoint) Data Security protector is a virtual machine that intercepts outbound HTTP traffic (posts). Then it analyzes the traffic to prevent data loss and sensitive data leak over the web. The protector communicates with a dedicated Windows server for DLP policy information and can monitor or block data from being posted when a match is detected. Content analysis is performed on the box, so no sensitive data leaves the protector during this process.

To use the protector's data loss prevention (DLP) capabilities, do the following;

- Purchase and install Websense Data Security
- Configure Web DLP policies in the Data Security manager
- Perform initial setup through the Management Service.

For more information, see the [Websense Protector](#) website.

### Provision a Websense Protector instance

The Websense© Protector requires a Data Security Management Server that must be configured outside the SDX appliance. Select exactly one management interface and two data interfaces. For the data interfaces, you must select Allow L2 Mode. Make sure that the Data Security Management Server can be accessed through the management network of the Websense protector. For the Name Server, type the IP address of the domain name server (DNS) that serves this protector.

**Note:** SR-IOV interfaces (1/x and 10/x) that are part of a channel do not appear in the list of interfaces. Channels are not supported on a Websense protector instance.

Download a protector image from the Websense website and upload it to the SDX appliance before you start provisioning the instance. For more information about downloading a protector image, see the [Websense website. Make sure that you are using Management Service build 118.7 or later on the SDX appliance.

On the **Configuration** tab, navigate to **Websense Protector > Software Images**.

### To upload an XVA image to the SDX appliance

1. In the details pane, under **XVA Files > Action**, click **Upload**.
2. In the dialog box that appears, click Browse, and then select the XVA file that you want to upload.
3. Click **Upload**. The XVA file appears in the XVA Files pane.



### To provision a Websense protector instance

1. On the **Configuration** tab, navigate to **Websense Protector > Instances**.
2. In the details pane, click **Add**.
3. In the **Provision Websense Protector** wizard, follow the instructions on the screen.
4. Click **Finish**, and then click **Close**.

After provisioning the instance, log on to the instance and perform the detailed configuration.

To modify the settings of a provisioned Websense protector instance, in the Websense Protector Instances pane, select the instance that you want to modify, and then click **Modify**. In the Modify Websense Protector wizard, set the parameters. Do not modify the interfaces that were selected at the time of provisioning a Websense instance. XVA file can be changed only after you delete the instance and provision a new one.

You can generate a tar archive for submission to technical support. For information about generating a technical support file, see [Generating a Tar Archive for Technical Support](#).

### Monitor a Websense Protector instance

The SDX appliance collects statistics, such as the version of [SDXTools](#), the status of the Websense® Data Security policy engine, and the Data Security proxy status.

To view the statistics related to a Websense protector instance:

1. Navigate to **Websense Protector > Instances**.
2. In the details pane, click the arrow next to the name of the instance.

### Manage a Websense Protector instance

You can start, stop, restart, force stop, or force restart a Websense® protector instance from the Management Service.

On the **Configuration** tab, expand **Websense Protector**.

### To start, stop, restart, force stop, or force restart a Websense protector instance

1. Click **Instances**.
2. In the details pane, select the instance on which you want to perform the operation, and then select one of the following options:
  - Start
  - Shut Down

- Reboot
  - Force Shutdown
  - Force Reboot
3. In the Confirm message box, click **Yes**.

### **Upgrade the SDX tools file for a Websense Protector instance**

**SDXTools**, a daemon running on the third-party instance, is used for communication between the Management Service and the third-party instance.

Upgrading **SDXTools** involves uploading the file to the SDX appliance, and then upgrading **SDXTools** after selecting an instance. You can upload an **SDXTools** file from a client computer to the SDX appliance.

#### **To upload an SDX tools file**

1. In the navigation pane, expand **Management Service**, and then click **SDXTools Files**.
2. In the details pane, from the **Action** list, select **Upload**.
3. In the **Upload SDXTools Files** dialog box, click **Browse**, navigate to the folder that contains the file, and then double-click the file.
4. Click **Upload**.

#### **To upgrade SDX tools**

On the **Configuration** tab, expand **Websense Protector**.

1. Click **Instances**.
2. In the details pane, select an instance.
3. From the **Action** list, select **Upgrade SDXTools**.
4. In the **Upgrade SDXTools** dialog box, select a file, click **OK**, and then click **Close**.

### **Upgrade the Websense Protector instance to a later version**

The process of upgrading the Websense© protector instance involves uploading the software image of the target build to the SDX appliance, and then upgrading the instance.

On the **Configuration** tab, expand **Websense Protector**.

### To upload the software image

1. Click **Software Images**.
2. In the details pane, from the **Action** list, select **Upload**.
3. In the dialog box, click **Browse**, navigate to the folder that contains the build file, and then double-click the build file.
4. Click **Upload**.

### To upgrade the instance

1. Click **Instances**.
2. In the details pane, select an instance.
3. From the **Action** list, select **Upgrade**.
4. In the dialog box that appears, select a file, click **OK**, and then click **Close**.

### Troubleshoot a Websense Protector instance

Ping a Websense protector instance from the Management Service to check whether the device is reachable. You can trace the route of a packet from the Management Service to an instance to determine the number of hops involved in reaching the instance.

Rediscover an instance to view the latest state and configuration of an instance. During rediscovery, the Management Service fetches the configuration and the version of the Websense protector running on the SDX appliance. By default, the Management Service schedules instances for rediscovery once every 30 minutes.

On the **Configuration** tab, expand **Websense Protector**.

### To ping an instance

1. Click **Instances**.
2. In the details pane, select the instance that you want to ping, and from the **Action** list, click **Ping**. The Ping message box shows whether the ping is successful.

### To trace the route of an instance

1. Click **Instances**.
2. In the details pane, select the instance for which you want to trace the route, and from the **Action** list, click **TraceRoute**. The Traceroute message box displays the route to the instance.

### To rediscover an instance

1. Click **Instances**.
2. In the details pane, select the instance that you want to rediscover, and from the **Action** list, click **Rediscover**.
3. In the Confirm message box, click **Yes**.

## BlueCat DNS/DHCP

August 1, 2023

BlueCat DNS/DHCP Server™ is a software solution supported by the NetScaler SDX appliance. It is hosted on the NetScaler SDX platform to deliver reliable, scalable, and secure DNS and DHCP core network services without incurring extra management costs or data center space. Critical DNS services can be load balanced across multiple DNS nodes within a single system or across multiple SDX appliances without the need for more hardware.

Virtual instances of BlueCat DNS/DHCP Server™ can be hosted on SDX to provide a smarter way to connect mobile devices, applications, virtual environments, and clouds.

To learn more about BlueCat and Citrix, visit the BlueCat website at <https://citrixready.citrix.com/bluecat-networks.html>.

If you are an existing BlueCat customer, you can download software and documentation via the BlueCat support portal at <https://care.bluecatnetworks.com/>.

### Provisioning a BlueCat DNS/DHCP instance

Download an XVA image from the BlueCat Customer Care, at <https://care.bluecatnetworks.com>. After you have downloaded the XVA image, upload it to the SDX appliance before you start provisioning the instance. Make sure that you are using Management Service build 118.7 or later on the SDX appliance.

Management channel across 0/1 and 0/2 interfaces are supported on BlueCat DNS/DHCP VMs. For more information see [Configuring channel from Management Service](#).

**Note:** SR-IOV interfaces (1/x and 10/x) that are part of a channel do not appear in the list of interfaces because channels are not supported on a BlueCat DNS/DHCP instance.

On the **Configuration** tab, navigate to **BlueCat DNS/DHCP > Software Images**.

**To upload an XVA image to the SDX appliance:**

1. In the details pane, under **XVA Files > Action**, click **Upload**.
2. In the dialog box that appears, click **Browse**, and then select the XVA file that you want to upload.
3. Click **Upload**. The XVA file appears in the XVA Files pane.

#### **To provision a BlueCat DNS/DHCP instance:**

1. On the Configuration tab, navigate to BlueCat DNS/DHCP > Instances.
2. In the details pane, click Add. The Provision BlueCat DNS/DHCP Server page opens.
3. In the Provision BlueCat DNS/DHCP wizard, follow the instructions on the screen.
  - Under Instance Creation, in the Name field, enter a name for the instance and select the uploaded image from the XVA File drop-down menu, then Click Next. Optionally, in the Domain Name field, enter a domain name for the instance.  
**Note:** The name must not contain spaces.
  - Under Network Settings, from the Management Interface drop-down menu, select the interface through which to manage the instance, set the IP address and gateway for that interface. You can assign interfaces explicitly for high availability and service. Select the parameters and then click **Next**.  
**Note:** When assigning interfaces for management, high availability and service, make sure you assign the interfaces based on the supported combination of interfaces:

You can select the same interface for all three.

You can select a different interface for all three.

You can select the same interface for management and service, but select a different interface for high availability.

Click **Finish**, and then click **Close**. The instance is created, booted, and configured with the selected IP address.

After you provision the instance, log on to the instance through SSH to complete the configuration. For details about configuring the BlueCat DNS/DHCP Server or place it under the control of the BlueCat Address Manager, see the BlueCat documentation, available at <https://care.bluecatnetworks.com>.

To modify the settings of a BlueCat DNS/DHCP Server instance, from the **BlueCat DNS/DHCP Instances** pane, select the instance that you want to modify, and then click **Modify**. In the Modify BlueCat DNS/DHCP wizard, modify the parameter settings.

**Note:** If you modify any of the interface parameters or the name of the instance, the instance stops and restarts to put the changes into effect.

#### **Monitor a BlueCat DNS/DHCP instance**

The SDX appliance collects statistics, such as the version of **SDXTools** running on the instance, of a BlueCat DNS/DHCP instance.

**To view the statistics related to a BlueCat DNS/DHCP instance:**

1. Navigate to BlueCat DNS/DHCP > Instances.
2. In the details pane, click the arrow next to the name of the instance.

**Manage a BlueCat DNS/DHCP instance**

You can start, stop, restart, force stop, or force restart a BlueCat DNS/DHCP instance from the Management Service.

On the **Configuration** tab, expand **BlueCat DNS/DHCP**.

**To start, stop, restart, force stop, or force restart a BlueCat DNS/DHCP instance:**

1. Click Instances.
2. In the details pane, select the instance on which you want to perform the operation, and then select one of the following options:
  - Start
  - Shut Down
  - Reboot
  - Force Shutdown
  - Force Reboot
3. In the Confirm message box, click Yes.

**Upgrade the SDXTools file for a BlueCat DNS/DHCP instance**

**SDXTools**, a daemon running on the third-party instance, is used for communication between the Management Service and the third-party instance.

Upgrading **SDXTools** involves uploading the file to the SDX appliance, and then upgrading **SDXTools** after selecting an instance. You can upload an **SDXTools** file from a client computer to the SDX appliance.

**To upload an SDXTools file:**

1. In the navigation pane, expand **Management Service**, and then click **SDXTools Files**.
2. In the details pane, from the **Action** list, select **Upload**.
3. In the **Upload SDXTools Files** dialog box, click **Browse**, navigate to the folder that contains the file, and then double-click the file.
4. Click **Upload**.

### To upgrade SDXTools:

On the **Configuration** tab, expand **BlueCat DNS/DHCP**.

1. Click **Instances**.
2. In the details pane, select an instance.
3. From the Action list, select **Upgrade SDXTools**.
4. In the **Upgrade SDXTools** dialog box, select a file, click **OK**, and then click **Close**.

### Rediscover a BlueCat DNS/DHCP instance

You can rediscover an instance to view the latest state and configuration of an instance. During re-discovery, the Management Service fetches the configuration. By default, the Management Service schedules instances for rediscovery of all instances once every 30 minutes.

On the **Configuration** tab, expand **BlueCat DNS/DHCP**.

1. Click **Instances**.
2. In the details pane, select the instance that you want to rediscover, and from the **Action** list, click **Rediscover**.
3. In the **Confirm** message box, click **Yes**.

## CA Access Gateway

August 1, 2023

CA Access Gateway is a scalable, manageable, and extensible stand-alone server that provides a proxy-based solution for access control. CA Access Gateway employs a proxy engine that provides a network gateway for the enterprise and supports multiple session schemes that do not rely on traditional cookie-based technology.

The embedded web agent enables Single Sign-On (SSO) across an enterprise. CA Access Gateway provides access control for HTTP and HTTPS requests and cookieless SSO. Also, the product stores session information in the in-memory session store. Proxy rules define how the CA Access Gateway forwards or redirects requests to resources located on destination servers within the enterprise.

By providing a single gateway for network resources, CA Access Gateway separates the corporate network and centralizes access control.

**Note:** SR-IOV interfaces (1/x and 10/x) that are part of a channel do not appear in the list of interfaces because channels are not supported on a CA Access Gateway instance. For more information about the features of CA Access Gateway, see the documentation for that product.

## Provision a CA Access Gateway instance

Before you can provision a CA Access Gateway instance, you must download an XVA image. After you have downloaded the XVA image, upload it to the SDX appliance. Make sure you are using Management Service version 10.5 build 52.3.e or later on the SDX appliance. To provision a CA Access Gateway, first you need to upload the XVA image to the SDX appliance and then provision an instance.

### To upload an XVA image to the SDX appliance:

1. On the **Configuration** tab, navigate to **CA Access Gateway > Software Images**.
2. In the details pane, under **XVA Files**, from the **Action** drop-down list, click **Upload**.
3. In the dialog box that appears, click **Browse**, and then select the XVA file that you want to upload.
4. Click **Upload**. The XVA file appears in the **XVA Files** pane.

### To provision a CA Access Gateway instance:

1. On the **Configuration** tab, navigate to **CA Access Gateway > Instances**.
2. In the details pane, click **Add**.
3. In the Provision CA Access Gateway wizard, follow the instructions on the screen.
4. Click **Finish**, and then click **Close**.

After you provision the instance, log on to the instance and perform the detailed configuration.

To modify the values of the parameters of a provisioned instance, in the details pane, select the instance that you want to modify, and then click **Modify**. In the Modify CA Access Gateway wizard, set the parameters to values suitable for your environment.

### Note:

If you modify any of the interface parameters or the name of the instance, the instance stops and restarts to put the change into effect.

## Monitor a CA Access Gateway instance

The SDX appliance collects statistics, such as the version of **SDXTools** running on the instance, of a CA Access Gateway instance.

### To view the statistics related to a CA Access Gateway instance:

1. Navigate to **CA Access Gateway > Instances**.
2. In the details pane, click the arrow next to the name of the instance.



## Manage a CA Access Gateway instance

You can start, stop, restart, force stop, or force restart a CA Access Gateway instance from the Management Service. To complete these tasks, follow these steps:

1. On the **Configuration** tab, expand **CA Access Gateway**.
2. Navigate to **CA Access Gateway > Instances**.
3. In the details pane, select the instance on which you want to perform the operation, and then select one of the following options:
  - Start
  - Shut Down
  - Reboot
  - Force Shutdown
  - Force Reboot
4. In the Confirm message box, click **Yes**.

## Palo Alto Networks VM-Series

August 1, 2023

Palo Alto Networks VM-Series virtual firewalls use the same PAN-OS feature set that is available in the company's physical security appliances, providing all key network security functions. VM-Series on NetScaler SDX enables consolidation of advanced security and ADC capabilities on a single platform, for secure, reliable access to applications by businesses, business units, and service-provider customers. The combination of VM-Series on NetScaler SDX also provides a complete, validated, security and ADC solution for Citrix Virtual Apps and Desktops deployments.

You can provision, monitor, manage, and troubleshoot an instance from the Management Service.

### Points to note:

- The total number of instances that you can provision on an SDX appliance depends on the SDX hardware resources available.
- SR-IOV interfaces (1/x and 10/x) that are part of a channel do not appear in the list of interfaces because channels are not supported on a Palo Alto VM-Series instance. For more information about the Palo Alto Network VM-Series, see [Palo Alto Network Documentation](#).

## Provision a PaloAlto VM-Series instance

Before you can provision a Palo Alto VM-Series instance, you must download an XVA image from the [Palo Alto Networks website](#). After you have downloaded the XVA image, upload it to the SDX appliance.

### To upload an XVA image to the SDX appliance:

1. On the **Configuration** tab, navigate to **PaloAlto VM-Series > Software Images**.
2. In the details pane, under **XVA Files**, from the **Action** drop-down list, click **Upload**.
3. In the dialog box that appears, click **Browse**, and then select the XVA file that you want to upload.
4. Click **Upload**. The XVA file appears in the **XVA Files** pane.

### To provision a Palo Alto VM-Series instance:

1. On the **Configuration** tab, navigate to **PaloAlto VM-Series > Instances**.
2. In the details pane, click **Add**.
3. In the Provision PaloAlto VM-Series wizard, follow the instructions on the screen.
4. Click **Finish**, and then click **Close**.

After provisioning the instance, log on to the instance and perform the detailed configuration.

To modify the values of the parameters of a provisioned instance, in the details pane, select the instance that you want to modify, and then click **Modify**. In the Modify PaloAlto VM-Series wizard, set the parameters to values suitable for your environment.

**Note:** If you modify any of the interface parameters or the name of the instance, the instance stops and restarts to put the change into effect.

## Monitor a Palo Alto VM-Series instance

The SDX appliance collects statistics, such as the version of [SDXTools](#) running on the instance, of a Palo Alto VM-Series instance.

### To view the statistics related to a Palo Alto VM-Series instance:

1. Navigate to **PaloAlto VM-Series > Instances**.
2. In the details pane, click the arrow next to the name of the instance.

## Manage a PaloAlto VM-Series instance

You can start, stop, restart, force stop, or force restart a PaloAlto VM-Series instance from the Management Service.

On the **Configuration** tab, expand **PaloAlto VM-Series**.

1. Navigate to **PaloAlto VM-Series > Instances**.
2. In the details pane, select the instance on which you want to perform the operation, and then select one of the following options:
  - Start
  - Shut Down
  - Reboot
  - Force Shutdown
  - Force Reboot
3. In the Confirm message box, click **Yes**.

### Troubleshoot a PaloAlto VM-Series instance

Ping a PaloAlto VM-Series instance from the Management Service to check whether the device is reachable. You can trace the route of a packet from the Management Service to an instance to determine the number of hops involved in reaching the instance.

Rediscover an instance to view the latest state and configuration of an instance. During rediscovery, the Management Service fetches the configuration and the version of the PaloAlto VM-Series running on the SDX appliance. By default, the Management Service schedules instances for rediscovery once every 30 minutes.

On the **Configuration** tab, expand **PaloAlto VM-Series**.

#### To ping an instance:

1. Click **Instances**.
2. In the details pane, select the instance that you want to ping, and from the **Action** list, click **Ping**. The **Pingmessage** box shows whether the ping is successful.

#### To trace the route an instance:

1. Click **Instances**.
2. In the details pane, select the instance that you want to ping, and from the **Action** list, click **TraceRoute**. The **Traceroute** message box displays the route to the instance.

#### To rediscover an instance:

1. Click **Instances**.
2. In the details pane, select the instance that you want to rediscover, and from the **Action** list, click **Rediscover**.
3. In the Confirm message box, click **Yes**.

## Deploy a Citrix SD-WAN VPX instance on a NetScaler SDX appliance

October 6, 2023

Citrix SD-WAN technology applies software-defined networking (SDN) concepts to WAN connections. The technology abstracts traffic management and monitoring from network hardware and applies them to individual applications. The result is improved performance, high-quality user experiences over geographically dispersed locations, and simplified deployment of wide-area and cloud-access networks. For more information, see [Citrix SD-WAN](#).

**Note:** Only the SD-WAN VPX Standard edition is supported. For more information, see [SD-WAN VPX editions](#).

Deploying a Citrix SD-WAN VPX instance on an SDX appliance includes the following tasks:

- Installing the hardware: ensure the SDX hardware is properly installed. For more information, see [Installing the Hardware](#).
- Setting up and configuring the SDX Management Service. For more information, see [Getting Started with the Management Service User Interface](#) and [Configuring the Management Service](#).
- Provisioning the SD-WAN VPX instance on the SDX appliance. For more information, see Provision the Citrix SD-WAN VPX instance on a NetScaler SDX.
- Configuring the SD-WAN VPX instance. For more information, see the [Configuration](#) documentations and [Configuring the virtual path service between the MCN and client sites](#).

### Prerequisites

Ensure you've the following licenses:

- Citrix SD-WAN VPX license
- NetScaler SDX platform license

### Citrix SD-WAN VPX requirements

The Citrix SD-WAN VPX on the SDX platform can act both as a site and MCN. The MCN can handle 1 Gb/s bidirectional throughput and 64 sites.

### Supported throughput for MCN and site

- 250 Mb/s to 1 Gb/s bidirectional throughput
- MCN supports 64 sites

**Hardware requirement for supported throughput** Site

- 4 CPUs to 16 CPUs
- 4 GB to 16 GB RAM
- 60 GB to 250 GB disk storage
- Minimum 4 NICs: one for management and remaining minimum 3 for data path

Master control node (MCN)

- 4, 8, and 16 CPUs
- 16 GB RAM
- 250 GB disk storage
- Minimum 4 NICs: one for management and remaining 3 for data path, with dedicated NICs for data path

**Data center topology**

You can deploy a Citrix SD-WAN VPX appliance on a NetScaler SDX in policy-based route (PBR) mode or in inline mode. See scenario 1 and 2 for data center topology for these two supported modes. For more information, see [Deploying SD-WAN in virtual inline mode](#).

Scenario 1: Inline Mode

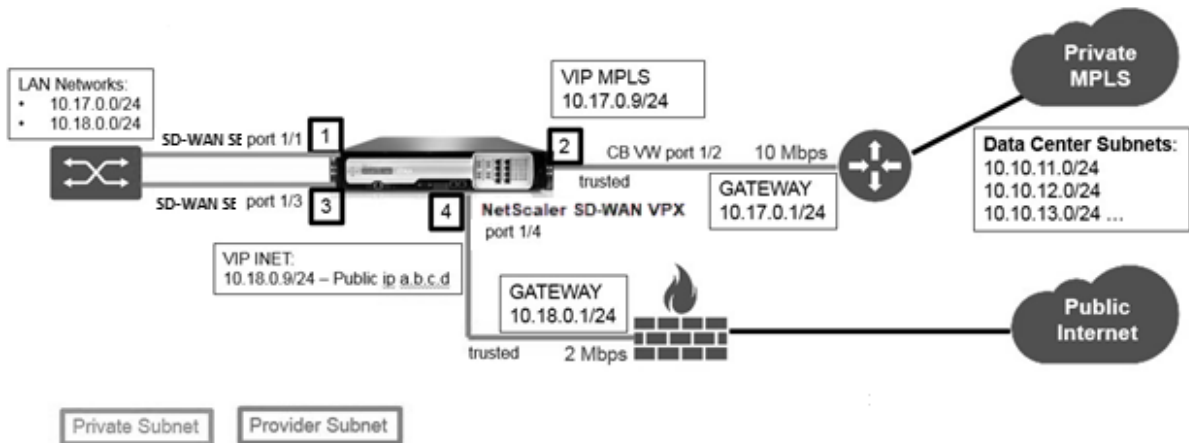

Scenario 2: PBR mode or virtual inline mode

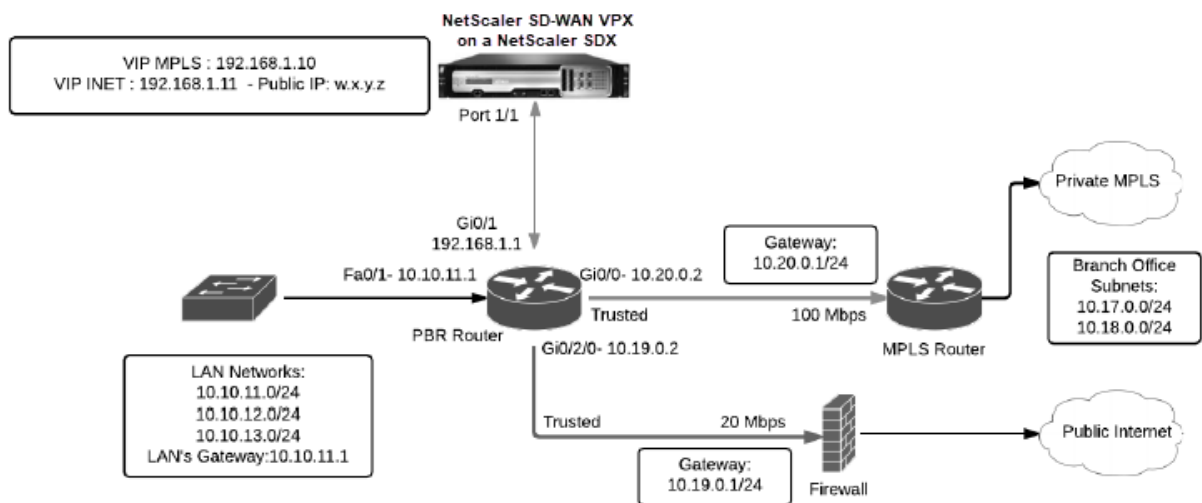

## Provision the Citrix SD-WAN VPX instance on a NetScaler SDX

Before you provision the Citrix SD-WAN VPX appliance, download the SD-WAN VPX image from the NetScaler product download site:

<https://www.citrix.com/downloads/netscaler-sd-wan/>.

Follow these steps to provision the Citrix SD-WAN VPX appliance.

1. Log on to the NetScaler SDX appliance.
2. Navigate to **Configuration > SD-WAN > Instances**.
3. Select **Software Images > Upload** and upload the SD-WAN XVA file.



4. Select **Instances > Add**. The **Provision SD-WAN Instance** page appears.
5. In the **Provision SD-WAN Instance** page, enter the following:
  - a. Name
  - b. IP address
  - c. Netmask
  - d. Gateway address
  - e. Upload the XVA file

f. Under **Resource Allocation**, allocate resources.

The screenshot shows a configuration window titled "Resource Allocation". It contains two input fields: "Total Memory (MB)\*" with the value "4096" and "CPU Cores\*" with a dropdown menu showing "Dedicated (4 CPU)". A small question mark icon is visible next to the CPU Cores dropdown.

g. Under **Network Settings**, provision management interfaces and select **OK** to create to provision the SD-WAN VPX instance on the SDX appliance.

**Note:** The SDX Management Service binds interfaces to the VPX instance in the ascending sequence of interface names. For example, if you add 1/4, and 1/1, Management Service arranges them as 1/1, 1/4.

When you add new interfaces, the existing sequence is retained and a new sequence is created. For example, you add interfaces 1/2, 10/1, 1/3. The new sequence would be 1/1, 1/4; 1/2, 1/3, 10/1.

6. The SD-WAN VPX instance appears under the **Instance page**. Here’s an example.



To edit the instance, navigate to **Configuration > SD-WAN > Instances**. Select and click the instance. Once you’ve completed editing, click **OK** to save the changes.

### Configuring the Citrix SD-WAN VPX instance

After you’ve created an SD-WAN instance on the SDX appliance, configure the SD-WAN instance by completing these two tasks:

1. Apply configuration for both MCN and site appliances.
2. Configure virtual path and transmit traffic.

For more information, see the following topics:

- [Configuration](#)
- [Configuring the virtual path service between the MCN and client sites](#)

### Related information

For more information about getting started with a Citrix SD-WAN appliance, see [Citrix SD-WAN](#).

For more information about the NetScaler SDX appliance, see [NetScaler SDX](#).

## Bandwidth Metering in SDX

December 12, 2023

NetScaler SDX bandwidth metering provides you with an accurate, reliable, and easy-to-use metering scheme that lets you efficiently allocate processing capacity and monetize bandwidth usage. A metering scheme is required to optimally allocate the bandwidth among various resources, keeping in mind that all the users at all the times get the allocated bandwidth.

The bandwidth allocation can be done in the following two modes:

- Dedicated bandwidth with a fixed rate of throughput
- Dedicated bandwidth with minimum assured throughput and bandwidth bursting ability

### Dedicated bandwidth with a fixed rate of throughput

In the bandwidth allocation method, each VPX instance is assigned a dedicated bandwidth. The instance is allowed to use the bandwidth up to the limit set. In dedicated mode the minimum and maximum bandwidth allocated are the same. If during a period, the VPX instance requires more bandwidth than allocated, then in the dedicated mode the instance cannot increase its throughput. This issue can be a downside if a VPX instance serves critical requests.

Also, if an SDX appliance has a few VPX instances and some of them are not utilizing their allocated bandwidth, you cannot share their unused bandwidth in dedicated mode. To overcome all these challenges, a dedicated bandwidth with minimum assured rate with the ability to dynamically increase the bandwidth is useful.

### Dedicated bandwidth with minimum assured throughput and bandwidth bursting ability

In this bandwidth allocation method, a VPX is allocated a minimum assured bandwidth with the flexibility to increase its bandwidth up to a preset limit. The extra bandwidth that a VPX can use is called burst capacity.

The benefit of burst capacity is seen when you have some instances that have extra capacity and some VPX with unused capacity. The extra capacity of these VPX instances can be allocated to other VPX instances that have fully utilized their allocated bandwidth and require more for some time. Various service providers are also interested in providing various add-on services to their customers that require dedicated capacity. At the same time they do not want to over provision bandwidth. Burstable bandwidth helps in such scenarios where the customers are assured of a specific bandwidth with the option to increase the bandwidth during high demand periods.



## Selecting the bandwidth allocation mode

Before you choose burstable throughput, you need to enable dynamic burst throughput allocation. To enable this option, follow these steps.

1. From the SDX Management Console, navigate to **Configuration > System**.
2. From the **System Settings** group, select **Change System Settings**.
3. Click the **Enable Dynamic Burst Throughput Allocation** check box to enable dynamic throughput.



### ← Configure System Settings

Communication with Citrix ADC Instance\*

https

Secure Access Only

Enable Session Timeout

Enable Dynamic Burst Throughput Allocation

Allow Basic Authentication

Enable nsrecover Login

Enable Shell access for non-nsroot User

OK Close

When you provision a VPX, you can select from bandwidth burst or dynamic throughput.

1. In the **SDX Management Service**, click **Configuration > NetScaler > Instances > Add**.
2. The **Provision NetScaler** page opens. Under **License Allocation**, choose **Burstable** from **Allocation Mode**.

License Allocation

Feature License\* Standard

For more information about Citrix ADC editions, see Citrix ADC Editions

Pool	Total	Available	Allocate
Instance	25	0	1
Bandwidth	100 Gbps	20 Gbps	Allocation Mode* Burstable Min (Mbps)* 1000 Max (Mbps) 0 Burst* P0

For more information about how to provision a NetScaler instance, see [Provisioning NetScaler instances](#).

If you want to use fixed rate of throughput, select **Fixed**. By default, fixed mode is set for bandwidth allocation. It is not necessary that all the VPX instances work in the same mode. Each VPX instance can be configured in different mode.

Note: If you are migrating SDX from 10.5.e and earlier versions, by default all the VPX instances are in the fixed allocation mode.

### Determining the maximum burst bandwidth for a VPX instance

The extent to which each VPX is allowed to burst is computed through an algorithm. When you provision a VPX with burstable bandwidth, then each such VPX has to be given a priority. The allocation of burstable bandwidth depends on this burst priority. The priority varies from P0 to P4 with P0 being the highest priority and P4 being the lowest.

Let us take a case where there are 2 VPX, namely VPX1 and VPX2. The minimum bandwidth allocated to VPX1 and VPX2 is 4 Gbps and 2 Gbps respectively with a burstable bandwidth of 2 Gbps and 1 Gbps each. The following table depicts the parameters:

VPX Name	Parameter	Value
VPX1	Minimum assured bandwidth	4Gbps
-	-	Maximum Burstable bandwidth 2Gbps
-	-	Priority P0
VPX2	Minimum assured bandwidth	2Gbps
-	-	Maximum Burstable bandwidth 1Gbps
-	-	Priority P1

In this case, let us assume that the total licensed bandwidth is 8 Gbps. If both the VPX instances are bursting to their maximum burstable limits, that is:

1. VPX1 is using its maximum burstable bandwidth, that is 2 Gbps then it is using a total of  $4 + 2 = 6$  Gbps
2. VPX2 is using its maximum burstable bandwidth, that is 1 Gbps then it is using a total of  $2 + 1 = 3$  Gbps

In this case the maximum bandwidth that is used is more than the licensed capacity of 8 Gbps. So to bring down the usage to a bandwidth within the licensed capacity, one of the VPX would have to give up its burstable bandwidth. In this case since VPX2 has lower priority than VPX1, so it gives up its 1 Gbps burstable bandwidth. VPX1 would continue to burst as it has higher priority than VPX2. In all such scenarios, it is made sure that the minimum guaranteed bandwidth is always honored.

## Checking the throughput and data consumption statistics

For each VPX, you can check the throughput and data consumption statistics in the graphs. To access the graphs, follow these steps:

1. From the SDX Management Service, go to **Configuration > NetScaler > Instances** page.
2. Select a VPX instance and then click the **Action drop** list.
3. From the list select either **Throughput Statistics** or **Data Usage Statistics**.

The graphs provide you to check the data consumption and throughput statistics for various periods of time, like:

- Last 1 hour
- Last 1 day
- Last 1 week
- Last 1 month, and
- Previous month

You can also select a specific time period in the graph by adjusting the slider at the bottom of the graph. Move your mouse over the lines in the graph to check the data consumption or throughput data for a specific time.

The following illustration shows a sample graph of throughput data for 1 week:

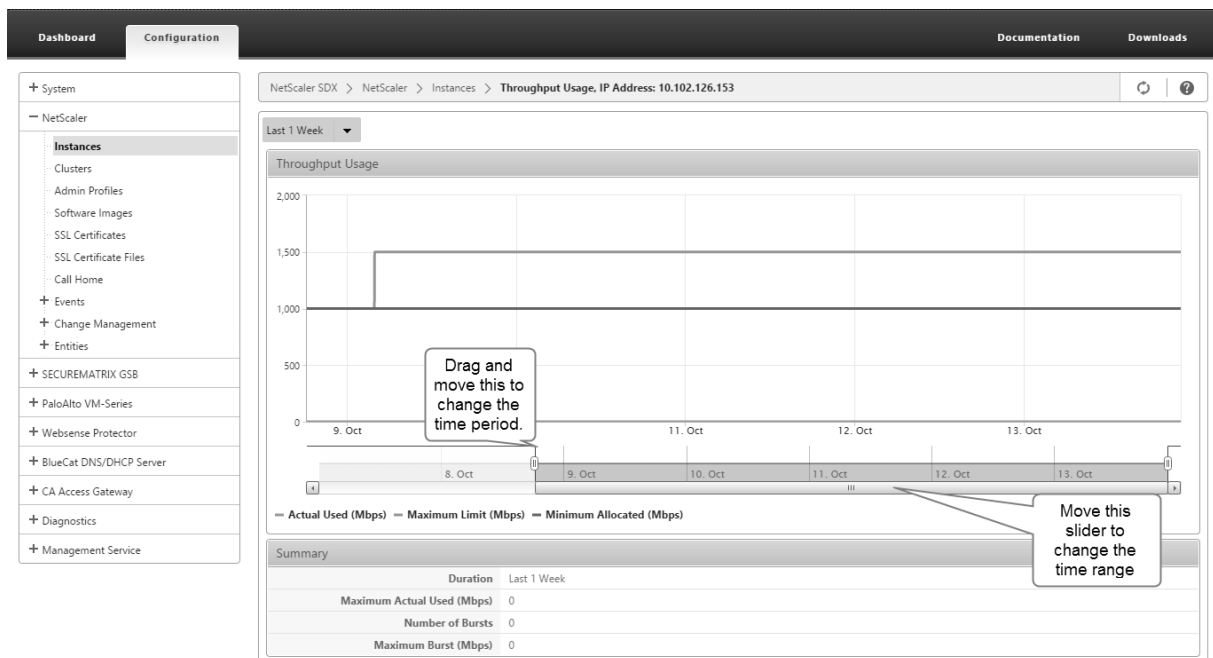

## Configure and manage NetScaler instances

August 1, 2023

After you have provisioned NetScaler instances on your appliance, you are ready to configure and manage the instances. Begin by creating a subnet IP (SNIP) address and then saving the configuration. You can then perform basic management tasks on the instances. Check to see if you have to apply the administration configuration.

**Warning:** Make sure that you modify the provisioned network interfaces or VLANs of an instance using the Management Service instead of performing the modifications directly on the instance.

### Create a SNIP address on a NetScaler instance

You can assign a SNIP address to the NetScaler instances after it is provisioned on the SDX appliance.

A SNIP is used in connection management and server monitoring. It is not mandatory to specify a SNIP when you initially configure the NetScaler SDX appliance. You can assign SNIP to the NetScaler instance from the Management Service.

### To add a SNIP Address on a NetScaler instance

1. On the **Configuration** tab, in the navigation pane, click **NetScaler**.

2. In the details pane, under **NetScaler Configuration**, click **Create IP**.
3. In the **Create NetScaler IP** dialog box, specify values for the following parameters.
  - **IP Address:** specify the IP address assigned as the SNIP address.
  - **Netmask:** specify the subnet mask associated with the SNIP address.
  - **Type:** By default the value is SNIP.
  - **Save Configuration:** Select to save the configuration on the NetScaler. Default value is false.
  - **Instance IP Address:** Specify the IP address of the NetScaler instance.
4. Click **Create**, and then click **Close**.

## Save the configuration

You can save the running configuration of a NetScaler instance from the Management Service.

### To save the configuration on a NetScaler instance

1. On the **Configuration** tab, in the navigation pane, click **NetScaler**.
2. In the details pane, under **NetScaler Configuration**, click **Save Configuration**.
3. In the **Save Configuration** dialog box, in **Instance IP Address**, select the IP addresses of the NetScaler instances whose configuration you want to save.
4. Click **OK**, and then click **Close**.

## Manage a NetScaler instance

The Management Service lets you perform the following operations on the NetScaler instances. You can perform these operations from the **NetScaler instances** pane in the **Configuration** tab or from the NetScaler instances gadget on the Home page.

**Start a NetScaler instance:** Start any NetScaler instance from the Management Service user interface. When the Management Service UI forwards this request to the Management Service, it starts the NetScaler instance.

**Shut down a NetScaler instance:** Shut down any NetScaler instance from the Management Service user interface. When the Management Service UI forwards this request to the Management Service, it stops the NetScaler instance.

**Reboot a NetScaler instance:** Restart the NetScaler instance.

**Delete a NetScaler instance:** If you do not want to use a NetScaler instance, you can delete that instance by using the Management Service. Deleting an instance permanently removes the instance

and its related details from the database of the SDX appliance.

### **To start, stop, delete, or restart a NetScaler instance**

1. On the **Configuration** tab, in the navigation pane, click **NetScaler instances**.
2. Select the NetScaler instance on which you want to perform the operation, and then click **Start** or **Shut Down** or **Delete** or **Reboot**.
3. In the Confirm message box, click **Yes**.

### **Remove NetScaler instance Files**

You can remove any NetScaler instance files, such as XVAs, builds, documentation, SSL keys or SSL certificates, from the appliance.

### **To remove NetScaler instance files**

1. On the **Configuration** tab, in the navigation pane, expand **NetScaler Configuration**, and then click the file that you want to remove.
2. In the details pane, select the file name, and then click **Delete**.

### **Apply the administration configuration**

At the time of provisioning a VPX instance, the Management Service creates some policies, an instance administration (admin) profile, and other configuration on the VPX instance. If the Management Service fails to apply the admin configuration, you can explicitly push the configuration from the Management Service to the VPX instance. One reason for the failure might be that the Management Service and the VPX instance are on different subnetworks and the router is down. Another reason might be that both are on the same subnet but traffic has to pass through an external switch and one of the links is down.

### **To apply the admin configuration on a NetScaler instance**

1. On the **Configuration** tab, in the navigation pane, click **NetScaler**.
2. In the details pane, under **NetScaler Configuration**, click **Apply Admin Configuration**.
3. In the **Apply Admin Configuration** dialog box, in **Instance IP Address**, select the IP address of the VPX instance on which you want to apply the admin configuration.
4. Click **OK**.

## Install and manage SSL certificates

August 1, 2023

The process of installing SSL certificates involves first uploading the certificate and key files to the NetScaler SDX appliance. Then install the SSL certificate on the NetScaler instances. When you install or update an SSL certificate on the SDX appliance, the Management Service reboots.

### Upload the certificate file to the SDX appliance

For any SSL transaction, the server needs a valid certificate and the corresponding private and public key pair. The certificate file must be present on the SDX appliance when you install the SSL certificate on the NetScaler instances. You can also download the SSL Certificate files to a local computer as a backup.

In the **SSL Certificates** pane, you can view the following details.

- **Name**

The name of the certificate file.

- **Last Modified**

The date when the certificate file was last modified.

- **Size**

The size of the certificate file in bytes.

### To upload SSL certificate files to the SDX appliance

1. In the navigation pane, expand Management Service, and then click SSL Certificate Files.
2. In the SSL Certificates pane, click Upload.
3. In the Upload SSL Certificate dialog box, click Browse and select the certificate file you want to upload.
4. Click Upload. The certificate file appears in the SSL Certificates pane.

### To create a backup by downloading an SSL certificate file

1. In the SSL Certificates pane, select the file that you want to download, and then click Download.
2. In the message box, from the Save list, select Save as.
3. In the Save As message box, browse to the location where you want to save the file, and then click Save.

## Uploading SSL Key Files to the SDX Appliance

For any SSL transaction, the server needs a valid certificate and the corresponding private and public key pair. The key file must be present on the SDX appliance when you install the SSL certificate on the NetScaler instances. You can also download the SSL key files to a local computer as a backup.

In the SSL Keys pane, you can view the following details.

- **Name**

The name of the key file.

- **Last Modified**

The date when the key file was last modified.

- **Size**

The size of the key file in bytes.

### To upload SSL key files to the SDX appliance

1. In the navigation pane, expand Management Service, and then click SSL Certificate Files.
2. In the SSL Certificate pane, on the SSL Keys tab, click Upload.
3. In the Upload SSL Key File dialog box, click Browse and select the key file you want to upload.
4. Click Upload to upload the key file to the SDX appliance. The key file appears in the SSL Keys pane.

### To create a backup by downloading an SSL key file

1. In the SSL Certificate pane, on the SSL Keys tab, select the file that you want to download, and then click Download.
2. In the message box, from the Save list, select Save as.
3. In the Save As message box, browse to the location where you want to save the file, and then click Save.

## Installing an SSL Certificate on a NetScaler instance

The Management Service lets you install SSL certificates on one or more NetScaler instances. Before you begin installing the SSL certificate, make sure that you have uploaded the SSL certificate and key files to the SDX appliance.



### To install SSL certificates on a NetScaler instance

1. In the navigation pane, click NetScaler.
2. In the details pane, under NetScaler Configuration, click Install SSL Certificates.
3. In the Install SSL Certificates dialog box, specify values for the following parameters. (\*) indicates required fields.
  - Certificate File: specify the file name of the valid certificate. The certificate file must be present on the SDX appliance.
  - Key File: specify the file name of the private-key used to create the certificate. The key file must be present on the SDX appliance.
  - Certificate Name: specify the name of the certificate-key pair to be added to the NetScaler. Maximum length: 31
  - Certificate Format: specify the format of the SSL certificate supported on the NetScaler. A NetScaler SDX appliance supports the PEM and DER formats for SSL certificates.
  - Password: Specify the pass-phrase that was used to encrypt the private-key. This option can be used to load encrypted private-keys. Max length: 32.  
**Note:** Password protected private key is supported only for the PEM format.
  - Save Configuration: specify whether the configuration must be saved on the NetScaler. Default value is false.
  - Instance IP Address: specify the IP addresses of the NetScaler instances on which you want to install the SSL certificate.
4. Click OK, and then click Close.

### Updating an SSL Certificate on a NetScaler instance

You can update some parameters, such as the certificate file, key file, and certificate format of an SSL certificate that is installed on a NetScaler instance. You cannot modify the IP address and certificate name.

### To update the SSL certificate on a NetScaler instance

1. In the navigation pane, expand NetScaler, and then click SSL Certificates.
2. In the SSL Certificates pane, click Update.
3. In the Modify SSL Certificate dialog box, set the following parameters:
  - Certificate File: the file name of the valid certificate. The certificate file must be present on the SDX appliance.

- **Key File:** the file name of the private-key used to create the certificate. The key file must be present on the SDX appliance.
- **Certificate Format:** the format of the SSL certificate supported on the NetScaler SDX appliance. The appliance supports the PEM and DER formats for SSL certificates.
- **Password:** the pass-phrase that was used to encrypt the private-key. This option can be used to load encrypted private-keys. Maximum length: 32 characters.

**Note:** Password protected private key is supported only for the PEM format.

- **Save Configuration:** specify whether the configuration must be saved on the SDX appliance. Default value is false.
- **No Domain Check:** Do not check the domain name while updating the certificate.

4. Click OK, and then click Close.

### **Polling for SSL Certificates on the NetScaler instances**

If you add an SSL certificate directly on a NetScaler instance after logging on to that instance, the Management Service is not aware of this new certificate. To avoid this scenario, specify a polling interval after which the Management Service polls all the NetScaler instances to check for new SSL certificates. You can also perform a poll at any time from the Management Service. For example, if you want to immediately get a list of the SSL certificates from all the NetScaler instances.

#### **To configure a polling interval**

1. In the navigation pane, expand NetScaler, and then click SSL Certificates.
2. In the SSL Certificates pane, click Configure Polling Interval.
3. In the Configure Polling Interval dialog box, set the following parameters:
  - **Polling Interval:** the time after which the Management Service polls the NetScaler instances.
  - **Interval Unit:** the unit of time. Possible values: Hours, Minutes. Default: Hours.
4. Click OK, and then click Close.

#### **To perform an immediate poll**

1. In the navigation pane, expand NetScaler, and then click SSL Certificates.
2. In the SSL Certificates pane, click Poll Now.
3. In the Confirm dialog box, click Yes. The SSL Certificates pane is refreshed and new certificates, if any, appear in the list.

## Allow L2 mode on a NetScaler instance

August 1, 2023

In Layer 2 (L2) mode, a NetScaler instance acts as a learning bridge and forwards all packets for which it is not the destination. Some features, such as Citrix CloudBridge, require that L2 mode be enabled on the NetScaler instance. With L2 mode enabled, the instance can receive and forward packets for MAC addresses other than its own MAC address. However, to enable L2 mode on a NetScaler instance running on a NetScaler SDX appliance, the administrator must first allow L2 mode on that instance. If you allow L2 mode, you must take precautions to avoid bridging loops.

### Precautions:

1. On a given 1/x interface, untagged packets must be allowed on only one instance. For all other instances enabled on the same interface, you must select Tagged.

#### Note:

Citrix recommends that you select Tagged for all interfaces assigned to instances in L2 mode. If you select tagged, you cannot receive untagged packets on that interface.

If you have selected Tagged for an interface assigned to an instance, log on to that instance and configure a 802.1q VLAN to receive packets on that interface.

2. For 1/x and 10/x interfaces that are shared by NetScaler instances on which L2 mode is allowed, make sure that the following conditions are met:
  - VLAN filtering is enabled on all the interfaces.
  - Each interface is on a different 802.1q VLAN.
  - Only one instance can receive untagged packets on the interface. If that interface is assigned to other instances, you must select Tagged on that interface for those instances.
3. If you allow untagged packets on a 1/x interface for an instance on which L2 mode is allowed, no other instance can receive untagged packets on that interface. This condition applies irrespective of whether L2 mode allowed or disallowed on the other instance.
4. If you allow untagged packets on a 1/x interface for an instance with L2 mode disabled, an instance with L2 mode allowed cannot receive untagged packets on that interface.
5. If a 0/x interface is assigned to instance1 provisioned in L2 mode, and that interface is also assigned to instance2, select Tagged for all other interfaces assigned to instance2.

**Note:** If both management interfaces are assigned to an instance with L2 mode, only one of these interfaces can be assigned to another ADC instance with L2 mode enabled. That is, you cannot associate both management interfaces with more than one NetScaler instance on which L2 mode is enabled.

## To allow L2 mode on an instance

1. In the Provision ADC Wizard or the Modify ADC Wizard, on the **Network Settings** page, select **Allow L2 Mode**.  
**Note:** You can activate the Allow L2 Mode setting on an instance when you provision the instance, or while the instance is running.
2. Follow the instructions in the wizard.
3. Click **Finish**, and then click **Close**.

## Configuring a Virtual MAC on an interface

October 6, 2023

A NetScaler instance uses a Virtual MAC (VMAC) for high availability (active-active or active-standby) configurations. A Virtual MAC address (VMAC) is a floating entity shared by the primary and the secondary nodes in a high availability setup.

In a high availability setup, the primary node owns all the floating IP addresses, such as the MIP, SNIP, and VIP addresses. The primary node responds to Address Resolution Protocol (ARP) requests for these IP addresses with its own MAC address. As a result, the ARP table of an external device (for example, an upstream router) is updated with the floating IP address and the primary node's MAC address.

When a failover occurs, the secondary node takes over as the new primary node. It then uses Gratuitous ARP (GARP) to advertise the floating IP addresses that it acquired from the primary. However, the MAC address that the new primary advertises is the MAC address of its own interface.

Some devices (notably a few routers) do not accept the GARP messages generated by the NetScaler SDX appliance. Such devices retain the old IP to MAC mapping advertised by the old primary node, and a site can go down as a result.

You can overcome this problem by configuring a VMAC on both nodes of an HA pair. Both nodes then possess identical MAC addresses. Therefore, when failover occurs, the MAC address of the secondary node remains unchanged, and the ARP tables on the external devices do not need to be updated.

Configuring a VMAC is a two-step process:

1. Configure VMAC on the SDX Management Service. You add a VRID for an interface or an LA channel. Configure VMAC on the SDX Management Service.
2. Configure VMAC on the Citrix instance. For information see the [Configure VMAC on Channel](#) group support article.

## Configure VMAC on the SDX Management Service

To configure VMAC, add an IPv4 or IPv6 VRID to an interface or LA channel from the Management Service. The Management Service internally generates a VMAC. Specify the same VRID when you configure active-active mode on the NetScaler instance. This active-active configuration is not supported on Mellanox interfaces.

Keep the following points in mind:

1. Add a VRID from the Management Service and specify the same VRID in the NetScaler instance. If you add a VRID directly in the NetScaler instance, the instance cannot receive a packet that has a VMAC address as the destination MAC address.
2. You cannot use the same VRID on different instances running in the same SDX appliance.
3. You can add or delete the VRIDs for an interface assigned to an instance while the Instance is running.
4. In an active-active configuration, you can specify more than one VRID for an interface assigned to an instance. The active-active deployment is not supported on Mellanox interfaces.
5. A maximum of 86 VMACs are allowed on a 10G interface, and a maximum of 16 VMACs on a 1G interface. If no more VMAC filters are available, reduce the number of VRIDs on another instance.

You can add a VRID at the time of adding a NetScaler VPX instance, or you can modify an existing NetScaler instance to add a VRID.

## To add an IPv4 or IPv6 VRID to an interface or LA channel

1. While adding a VPX instance on SDX, under **Network Settings**, select **Data Interfaces**. For more information about how to add a VPX instance on SDX, see [Add a NetScaler instance](#).
2. From the **Interfaces** drop-down menu, select the interface or the LA channel.
3. Under VMAC settings, and set one or both of the following values:
  - VRID IPv4—The IPv4 VRID that identifies the VMAC. Possible values: 1–255.
  - VRID IPv6—The IPv6 VRID that identifies the VMAC. Possible values: 1–255.

Note: Use a comma to separate multiple VRIDs. For example, 12,24.
4. Click **Add** to add the **VMAC** settings to the interface.
5. Click **Finish**, and then click **Close**.

### Add Data Interface

Interfaces\*

LA/1 (LACP)

The option "Allow Untagged Traffic" needs to be always enabled on a

Allow Untagged Traffic

VLANs

100-110,142,151-155

MAC Address Mode\*

Default

▼ VMAC Settings (IPv4 and IPv6 VRIDs to configure Virtual MAC)

VRID IPv4

2,10,111

VRID IPv6

2,10,111

If the instance is already provisioned, to add an IPv4 or IPv6 VRID, follow these steps.

1. From the SDX Management Service, go to **Configuration > NetScaler > Instances**.
2. Select the instance and click **Edit**.
3. Under **Data Interfaces**, select the interface and click edit.
4. Under VMAC settings, set the VRID values. Click **Add** and then click **Done**.

## Generate partition MAC addresses to configure an admin partition on a NetScaler instance in the SDX appliance

August 1, 2023

A NetScaler instance on a NetScaler SDX appliance can be partitioned into logical entities called admin

partitions. Each partition can be configured and used as a separate NetScaler instance. For more information about admin partitions, see [Admin Partitioning](#).

For using admin partitions with a shared VLAN configuration, you need a virtual MAC address for each partition. Such a virtual MAC address is called a partition MAC (PMAC) address, and it is used for classifying traffic received on a shared VLAN. This PMAC address is used across all the shared VLANs bound to that partition.

Generate and configure the PMAC address by using the Management Service user interface, before using the admin partition. Management Service enables you to generate partition MAC addresses by:

- Using a base MAC address
- Specifying custom MAC addresses
- Randomly generating MAC addresses

**Note**

After generating the partition MAC addresses, you must restart the NetScaler instance before configuring the admin partitions.

**To generate the partition MAC addresses by using a base MAC address:**

1. On the **Configuration** tab, in the left pane, expand **NetScaler**, and then click **Instances**.
2. In the **Instances** pane, select the NetScaler instance for which you want to generate the partition MAC addresses.
3. In the **Action** drop-down list, click **Partition MACs**.
4. In the **Partition MACs** pane, click **Generate**.
5. In the **Generate Partition MACs** dialog box, in the **Generation Method** section, select **Using Base Address**.
6. In the **Base MAC Address** field, enter the base MAC address.
7. In the **Increment By** field, enter the value by which the base MAC address must be incremented for each subsequent MAC address.  
For example, if you have specified the base MAC address as 00:A1:C9:11:C8:11 and the increment value as 2, the next MAC address is generated as 00:A1:C9:11:C8:13.
8. In the **Count** field, enter the number of partition MAC addresses you want to generate.
9. Click **Generate**.

**To generate the partition MAC addresses by specifying custom MAC addresses:**

1. On the **Configuration** tab, in the left pane, expand **NetScaler**, and then click **Instances**.
2. In the **Instances** pane, select the NetScaler instance for which you want to generate the partition MAC addresses.
3. In the **Action** drop-down list, click **Partition MACs**.
4. In the **Partition MACs** pane, click **Generate**.

5. In the **Generate Partition MACs** dialog box, in the **Generation Method** section, select **User Specified**.
6. In the **MAC Addresses** field, enter a MAC address.
7. Click the **+** icon, and then enter the next MAC address. Repeat to specify more custom MAC addresses.
8. Click **Generate**.

**To randomly generate the partition MAC addresses:**

1. On the **Configuration** tab, in the left pane, expand **NetScaler**, and then click **Instances**.
2. In the **Instances** pane, select the NetScaler instance for which you want to generate the partition MAC addresses.
3. In the **Action** drop-down list, click **Partition MACs**.
4. In the **Partition MACs** pane, click **Generate**.
5. In the **Generate Partition MACs** dialog box, in the **Generation Method** section, select **Random**.
6. In the **Count** field, enter the number of partition MAC addresses you want to generate.
7. Click **Generate**.

After you have generated partition MAC addresses in an SDX appliance, use the generated partition MAC addresses to configure admin partitions on the NetScaler instance.

## Change management for VPX instances

August 1, 2023

You can track any changes to the configuration on a NetScaler VPX instance from the Management Service. The details pane lists the device name with IP address, date, and time when it was last updated. It also lists whether there is any difference between the saved configuration and the running configuration. Select a device to view its running configuration, saved configuration, history of configuration changes, and any difference between the configurations before and after an upgrade. You can download the configuration of a VPX instance to your local computer. By default, the Management Service polls all the instances every 24 hours, but you can change this interval. You can create an audit template by copying the commands from an existing configuration file. You can later use this template to find any changes in the configuration of an instance and take corrective action if necessary.

**To view change management for VPX instances**

1. On the **Configuration** tab, navigate to **NetScaler > Change Management**.
2. In the **Change Management** pane, select a VPX instance, and then from the **Action** list, select one of the following:



- **Running Configuration**—Displays the running configuration of the selected VPX instance in a new window.
- **Saved Configuration**—Displays the saved configuration of the selected VPX instance in a new window.
- **Saved Vs. Running Diff**—Displays the saved configuration, the running configuration, and the corrective command (the difference).
- **Revision History Diff**—Displays the difference between the base configuration file and the second configuration file.
- **Pre vs. Post Upgrade Diff**—Displays the difference in the configuration before and after an upgrade, and the corrective command (the difference).
- **Template Diff**—Displays the difference between the saved or running configuration and the template. You can save this difference as a batch file. To apply the configuration from the template to the instance, apply this batch file to the instance.
- **Download**—Downloads the configuration of the selected VPX instance and saves it on a local device.

### **To poll for updates to the configuration of any of the NetScaler instances**

1. On the **Configuration** tab, navigate to **NetScaler > Change Management**.
2. In the **Change Management** pane, from the **Action** list, select one of the following:
  - **Poll Now**—Management Service performs an immediate poll for updates to the configuration (ns.conf) of any of the VPX instances installed on the appliance.
  - **Configure Polling Interval**—Time after which the Management Service polls for updates to the configuration (ns.conf) of any of the VPX instances installed on the appliance. The default polling interval is 24 hours.

### **To configure an audit template for a NetScaler instance**

1. Open an existing configuration file and copy its list of commands.
2. On the **Configuration** tab, navigate to **NetScaler > Change Management > Audit Templates**.
3. In the details pane, click **Add**.
4. In the **Add Template** dialog box, add a name and description for the template.
5. In the **Command** text box, paste the list of commands that you copied from the configuration file.
6. Click **Create**, and then click **Close**.

## Monitor NetScaler instances

August 1, 2023

A high-level view of the performance of the appliance and the VPX instances provisioned on the appliance are displayed on the Monitoring page of the Management Service user interface. After provisioning and configuring the NetScaler instance, you can perform various tasks to monitor the NetScaler instance.

### View the properties of VPX instances

The Management Service user interface displays the list and description of all the VPX instances provisioned on the SDX appliance. Use the **NetScaler instances** pane to view details, such as the instance name and IP address, CPU and memory utilization, throughput and total memory assigned to the instance.

Clicking the IP address of the VPX instance opens the configuration utility (GUI) of that instance in a new tab or browser.

### To view the properties of VPX instances

1. On the Configuration tab, in the left pane, expand NetScaler Configuration, and then click Instances.

Note: You can also view the properties of a VPX instance from the Home tab.

2. In the NetScaler instance pane, you can view the following details for the NetScaler instance:
  - **Name:** The host name assigned to the NetScaler instance while provisioning.
  - **VM State:** The state of the virtual machine.
  - **NetScaler State:** The state of the NetScaler instance.
  - **IP Address:** The IP address of the NetScaler instance. Clicking the IP address opens the GUI of this instance in a new tab or browser.
  - **Rx (Mbps):** The packets received on the NetScaler instance.
  - **Tx (Mbps):** The packets transmitted by the NetScaler instance.
  - **HTTP Req/s:** The total number of HTTP requests received on the NetScaler instance every second.
  - **CPU Usage (%):** The percentage of CPU utilization on the NetScaler.
  - **Memory Usage (%):** The percentage of memory utilization on the NetScaler.

3. Click the arrow next to the name of a NetScaler instance to view the properties of that instance. You can also click **Expand All** to view the properties of all the NetScaler instances. You can view the following properties:

- **Netmask:** The netmask IP address of the NetScaler instance.
- **Gateway:** The IP address of the default gateway, the router that forwards traffic outside of the subnet in which the instance is installed.
- **Packets per second:** The total number of packets passing every second.
- **NICs:** The names of the NICs used by the NetScaler instance, along with the virtual function assigned to each interface.
- **Version:** The build version, build date, and time of the NetScaler software currently running on the instance.
- **Host Name:** The host name of the NetScaler instance.
- **Total Memory (GB):** The total memory being assigned to the NetScaler instance.
- **Throughput (Mbps):** The total throughput of the NetScaler instance.
- **Up Since:** The date and time since when the instance has been continuously in the UP state.
- **SSL Chips:** The total number of SSL chips assigned to the instance.
- **Peer IP address:** The IP address of the peer of this NetScaler instance if it is in an HA setup.
- **Status:** The status of the operations being performed on a NetScaler instance, such as the status of whether the inventory from the instance is completed.
- **HA Master State:** The state of the device. The state indicates whether the instance is configured in a standalone or primary setup or is part of a high availability setup. In a high availability setup, the state also displays whether it is in primary or secondary mode.
- **HA Sync Status:** The mode of the HA sync status, such as enabled or disabled.
- **Description:** The description entered while provisioning the NetScaler instance.

#### Notes:

When an ADC instance goes out of service due to authentication failure, the instance state color changes to gray if the following conditions are met:

- The ADC instance password is changed directly using the instance CLI.
- The password doesn't match the instance admin profile password stored in the Management Service.
- The previous session is lost after you reboot the instance for the first time.

Typically, when an instance goes out of service, the instance state color is yellow.

To recover the instance, do one of the following:

- From the instance CLI, modify the password of the instance to match the password in the

- admin profile of the instance. Then rediscover the instance from the Management Service.
- Create an admin profile with the same password as the current password of the ADC instance. Then, update the ADC instance with the new admin profile.

## **View the running and saved configuration of a NetScaler instance**

By using the Management Service you can view the currently running configuration of a NetScaler instance. You can also view the saved configuration of a NetScaler instance and the time when the configuration was saved.

### **To view the running and saved configuration of a NetScaler instance**

1. On the Configuration tab, in the left pane, expand NetScaler Configuration, and then click Instances.
2. In the NetScaler instances pane, click the NetScaler instance for which you want to view the running or saved configuration.
3. To view the running configuration, click Running Configuration, and to view the saved configuration, click Saved Configuration.
4. In the NetScaler Running Config window or the NetScaler Saved Config window, you can view the running or saved configuration of the NetScaler instance.

## **Ping a NetScaler instance**

You can ping a NetScaler instance from the Management Service to check whether the device is reachable.

### **To ping a NetScaler instance**

1. On the Configuration tab, in the left pane, expand NetScaler Configuration, and then click Instances.
2. In the NetScaler instances pane, click the NetScaler instance you want to ping, and then click Ping. In the Ping message box, you can view whether the ping is successful.

## **Trace the route of a NetScaler instance**

You can trace the route of a packet from the Management Service to a NetScaler instance by determining the number of hops used to reach the instance.

### To trace the route of a NetScaler instance

1. On the Configuration tab, in the left pane, expand NetScaler Configuration, and then click Instances.
2. In the NetScaler instances pane, click the NetScaler instance you want to trace, and then click TraceRoute. In the Traceroute message box, you can view the route to the NetScaler.

### Rediscover a NetScaler instance

You can rediscover a NetScaler instance when you need to view the latest state and configuration of a NetScaler instance.

During rediscovery, the Management Service fetches the configuration. By default, the Management Service schedules devices for rediscovery once every 30 minutes.

### To rediscover a NetScaler instance

1. On the **Configuration** tab, in the left pane, expand **NetScaler Configuration**, and then click **Instances**.
2. In the **NetScaler instances** pane, click the NetScaler instance you want to rediscover, and then click **Rediscover**.
3. In the Confirm message box, click **Yes**.

## Use logs to monitor operations and events

August 1, 2023

Use audit and task logs to monitor the operations performed on the Management Service and on the NetScaler SDX instances. You can also use the events log to track all events for tasks performed on the Management Service and the Citrix Hypervisor.

### View the audit logs

All operations performed by using the Management Service are logged in the appliance database. Use audit logs to view the operations that a Management Service user has performed, the date and time, and the success or failure status of each operation. You can also sort the details by user, operation, audit time, status, and so on by clicking the appropriate column heading.

Pagination is supported in the Audit Log pane. Select the number of records to display on a page. By default, 25 records are displayed on a page.

To view audit logs, follow these steps:

1. In the navigation pane, expand System, and then click Audit.
2. In the Audit Log pane, you can view the following details.
  - **User Name:** the Management Service user who has performed the operation.
  - **IP Address:** the IP address of the system on which the operation was performed.
  - **Port:** the port at which the system was running when the operation was performed.
  - **Resource Type:** the type of resource used to perform the operation, such as xen\_vpx\_image and login.
  - **Resource Name:** the name of the resource used to perform the operation, such as vpx\_image\_name and the user name used to log in.
  - **Audit Time:** the time when the audit log was generated.
  - **Operation:** the task that was performed, such as add, delete, and log out.
  - **Status:** the status of the audit, such as Success or Failed.
  - **Message:** a message describing the cause of failure if the operation has failed and the status of the task, such as Done, if the operation was successful.
3. To sort the logs by a particular field, click the heading of the column.

## View task logs

Use task logs to view and track tasks, such as upgrading instances and installing SSL certificates, that are run by the Management Service on the NetScaler instances. The task log lets you view whether a task is in progress or has failed or has succeeded.

Pagination is supported in the **Task Log** pane. Select the number of records to display on a page. By default, 25 records are displayed on a page.

To view the task log, follow these steps:

1. In the navigation pane, expand Diagnostics, and then click Task Log.
2. In the Task Log pane, you can view the following details.
  - **Name:** the name of the task that is being run or has already been run.
  - **Status:** the status of the task, such as In progress, Completed, or Failed.
  - **Executed By:** the Management Service user who has performed the operation.
  - **Start Time:** the time at which the task started.
  - **End Time:** the time at which the task ended.

### View task device logs

Use task device logs to view and track tasks being performed on each SDX instance. The task device log lets you view whether a task is in progress or has failed or has succeeded. It also displays the IP address of the instance on which the task is performed.

To view the task device log, follow these steps:

1. In the navigation pane, expand **Diagnostics**, and then click **Task Log**.
2. In the **Task Log** pane, double-click the task to view the task device details.
3. In the **Task Device Log** pane, to sort the logs by a particular field, click the heading of the column.

### View task command logs

Use task command logs to view the status of each command of a task run on a NetScaler instance. The task command log lets you view whether a command has been successfully run or has failed. It also displays the command that is run and the reason why a command has failed.

To view the task command log, follow these steps:

1. In the navigation pane, expand **Diagnostics**, and then click **Task Log**.
2. In the **Task Log** pane, double-click the task to view the task device details.
3. In the **Task Device Log** pane, double-click the task to view the task command details.
4. In the **Task Command Log** pane, to sort the logs by a particular field, click the heading of the column.

### View events

Use the **Events** pane in the Management Service user interface to monitor the events generated by the Management Service for tasks performed on the Management Service.

To view the events, follow these steps:

1. Navigate to **System > Events**.
2. In the **Events** pane, you can view the following details.
  - **Severity:** the severity of an event, which might be critical, major, minor, clear, and information.
  - **Source:** the IP address on which the event is generated.
  - **Date:** the date when the event is generated.
  - **Category:** the category of event, such as PolicyFailed and DeviceConfigChange.
  - **Message:** the message describing the event.

3. To sort the events by a particular field, click the heading of the column.

## Use cases for NetScaler SDX appliances

August 1, 2023

For networking components (such as firewalls and Application Delivery Controllers), support for multi-tenancy has historically involved the ability to carve a single device into multiple logical partitions. This approach allows different sets of policies to be implemented for each tenant without the need for numerous, separate devices. Traditionally, however it is severely limited in terms of the degree of isolation that is achieved.

By design, the SDX appliance is not subject to the same limitations. In the SDX architecture, each instance runs as a separate virtual machine (VM) with its own dedicated NetScaler kernel, CPU resources, memory resources, address space, and bandwidth allocation. Network I/O on the SDX appliance not only maintains aggregate system performance but also enables complete segregation of each tenant's data-plane and management-plane traffic. The management plane includes the 0/x interfaces. The data plane includes the 1/x and 10/x interfaces. A data plane can also be used as a management plane.

The primary use cases for an SDX appliance are related to consolidation, reducing the number of networks required while maintaining management isolation. Following are the basic consolidation scenarios:

- Consolidation when the Management Service and the NetScaler instances are in the same network.
- Consolidation when the Management Service and the NetScaler instances are in different networks but all the instances are in the same network.
- Consolidation across security.
- Consolidation with dedicated interfaces for each instance.
- Consolidation with sharing of a physical port by more than one instance.

### Consolidation when the Management Service and the NetScaler instances are in the same network

August 1, 2023

A simple type of consolidation case on the SDX appliance is the configuration of the Management Service and the NetScaler instances as part of the same network. This use case is applicable if:



- The appliance administrator is also the instance administrator.
- Your organization’s compliance requirement does not specify that separate management networks are required for the Management Service and the NSIP addresses of the different instances.

The instances can be provisioned in the same network (for management traffic). The VIP addresses can be configured in different networks (for data traffic), and thus in different security zones.

In the following example, the Management Service and the NetScaler instances are part of the 10.1.1.x network. Interfaces 0/1 and 0/2 are the management interfaces, 1/1 to 1/8 are 1G data interfaces, and 10/1 to 10/4 are 10G data interfaces. Each instance has its own dedicated physical interface. Therefore, the number of instances is limited to the number of physical interfaces available on the appliance. By default, VLAN filtering is enabled on each interface of the SDX appliance. The number of VLANs is restricted to 32 on a 1G interface and 63 on a 10G interface. VLAN filtering can be enabled and disabled for each interface. Disable VLAN filtering to configure up to 4096 VLANs per interface on each instance. In this example, VLAN filtering is not required because each instance has its own dedicated interface. For more information about VLAN filtering, see the **VLAN filtering** section in [Manage and monitor the SDX appliance](#).

The following figure illustrates the preceding use case.

Figure 1. Network topology of an SDX appliance with Management Service and NSIPs for instances in the same network

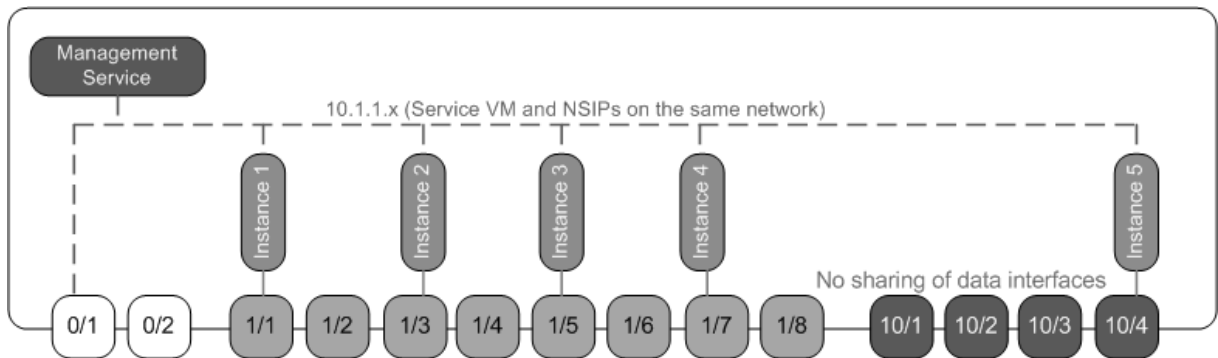

The following table lists the names and values of the parameters used for provisioning NetScaler instance 1 in the preceding example.

Parameter Name	Values for Instance 1
Name	vpx8
IP Address	10.1.1.2
Netmask	255.255.255.0
Gateway	10.1.1.1

---

Parameter Name	Values for Instance 1
XVA File	NS-VPX-XEN-10.0-51.308.a_nc.xva
Feature License	Platinum
Admin Profile	ns_nsroot_profile
User Name	vpx8
Password	Sdx1
Confirm Password	Sdx1
Shell/Sftp/Scp Access	True
Total Memory (MB)	2048
#SSL Chips	1
Throughput (Mbps)	1000
Packets per second	1000000
CPU	Shared
Interface	0/1 and 1/1

---

### **Provision NetScaler instance 1 as shown in this example**

1. On the Configuration tab, in the navigation pane, expand NetScaler Configuration, and then click Instances.
2. In the NetScaler instances pane, click Add.
3. In the Provision Citrix Wizard follow the instructions in the wizard to specify the parameter values shown in the preceding table.
4. Click Create, and then click Close. The NetScaler instance you provisioned appears in the NetScaler instances pane.

### **Consolidation when the Management Service and the NetScaler instances are in different networks**

August 1, 2023

In certain cases, the appliance administrator might allow other administrators to perform administration tasks on individual instances. This can be safely done by giving an individual instance administra-

tor login rights to just that instance. But, for security reasons, the appliance administrator might not want to allow the instance to be on the same network as the Management Service. This is a common scenario in service provider environments, and it is becoming increasingly common in enterprises as they adopt virtualization and cloud architectures.

In the following example, the Management Service is in the 10.1.1.x network and the NetScaler instances are in the 10.1.2.x network. Interfaces 0/1 and 0/2 are the management interfaces, 1/1 to 1/8 are 1G data interfaces, and 10/1 to 10/4 are 10G data interfaces. Each instance has its own dedicated administrator and its own dedicated physical interface. Therefore, the number of instances is limited to the number of physical interfaces available on the appliance. VLAN filtering is not required, because each instance has its own dedicated interface. Optionally, disable VLAN filtering to configure up to 4096 VLANs per instance per interface. In this example, you do not need to configure an NSVLAN, because the instances are not sharing a physical interface and there are no tagged VLANs. For more information about NSVLANs, see [Adding a NetScaler instance](#)

The following figure illustrates the preceding use case.

Figure 1. Network topology of an SDX appliance with Management Service and NSIPs for Instances in different networks

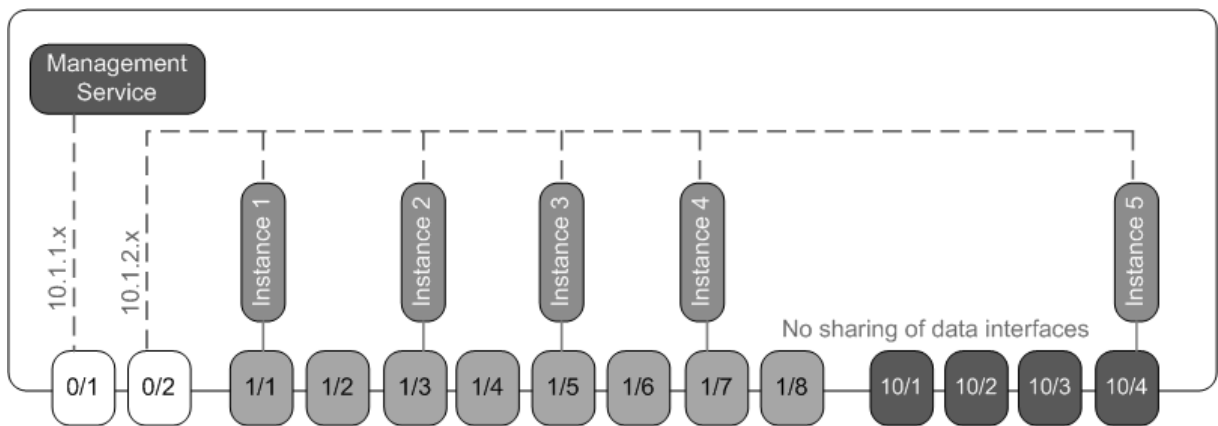

As the appliance administrator, you can keep the traffic between the Management Service and the NSIP addresses on the SDX appliance. Or you can force the traffic off the device if, for example, you want traffic to go through an external firewall or some other security intermediary and then return to the appliance.

The following table lists the names and values of the parameters used for provisioning NetScaler instance 1 in this example.

Parameter Name	Values for Instance 1
Name	vpx1
IP Address	10.1.2.2

---

Parameter Name	Values for Instance 1
Netmask	255.255.255.0
Gateway	10.1.2.1
XVA File	NS-VPX-XEN-10.0-51.308.a_nc.xva
Feature License	Platinum
Admin Profile	ns_nsroot_profile
User Name	vpx1
Password	Sdx1
Confirm Password	Sdx1
Shell/Sftp/Scp Access	True
Total Memory (MB)	2048
#SSL Chips	1
Throughput (Mbps)	1000
Packets per second	1000000
CPU	Shared
Interface	0/2 and 1/1

---

### To provision NetScaler instance 1 as shown in this example

1. On the **Configuration** tab, in the navigation pane, expand **NetScaler Configuration**, and then click **Instances**.
2. In the NetScaler instances pane, click **Add**.
3. In the **Provision NetScaler Wizard** follow the instructions in the wizard to set the parameters to the values shown in the preceding table.
4. Click **Create**, and then click **Close**. The NetScaler instance you provisioned appears in the NetScaler instances pane.

### Consolidation across security zones

August 1, 2023

An SDX appliance is often used for consolidation across security zones. The DMZ adds an extra layer of security to an organization's internal network, because an attacker has access only to the DMZ. It does not have access to the internal network of the organization. In high-compliance environments, a single NetScaler instance with VIP addresses in both the DMZ and an internal network is not acceptable. With SDX, you can provision instances hosting VIP addresses in the DMZ, and other instances hosting VIP addresses in an internal network.

Sometimes, you might need separate management networks for each security zone. The NSIP addresses of the instances in the DMZ can be in one network. The NSIP addresses of the instances with VIPs in the internal network can be in a different management network. Also, often, communication between the Management Service and the instances might need to be routed through an external device, such as a router. You can configure firewall policies to control the traffic that is sent to the firewall and to log the traffic.

The SDX appliance has two management interfaces (0/1 and 0/2) and, depending on the model, up to eight 1G data ports and eight 10G data ports. You can also use the data ports as management ports (for example, when you need to configure tagged VLANs, because tagging is not allowed on the management interfaces). If you do so, the traffic from the Management Service must leave the appliance and then return to the appliance. You can route this traffic or, optionally, specify an NSVLAN on an interface assigned to the instance. If a management interface is common between an instance and the Management Service, the traffic between the two does not have to be routed. However, if your setup explicitly requires it, the traffic can be routed.

**Note** Tagging is supported in Citrix Hypervisor version 6.0.

## Consolidation with dedicated interfaces for each instance

August 1, 2023

In the following example, the instances are part of multiple networks. Interface 0/1 is assigned to the Management Service, which is part of the internal 10.1.1.x network. NetScaler instances 2 and 3 are part of the 10.1.200.x network (VLAN 100). NetScaler instances 4 and 5 are part of the 10.1.3.x network (VLAN 200).

Optionally, you can configure an NSVLAN on all the instances.

The following figure illustrates the preceding use case.

Figure 1. Network topology of an SDX appliance with NetScaler instances in multiple networks

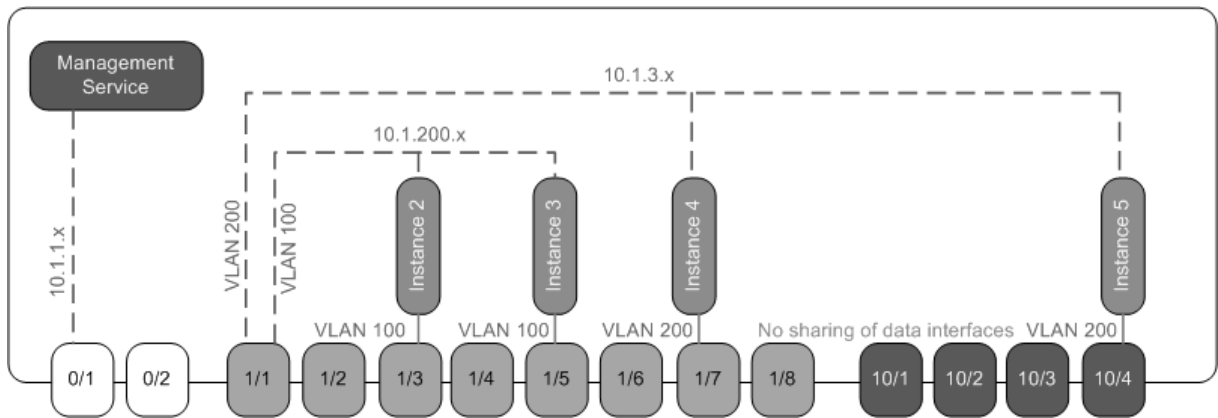

The SDX appliance is connected to a switch. Make sure that VLAN IDs 100 and 200 are configured on the switch port to which port 1/1 on the appliance is connected.

The following table lists the names and values of the parameters used for provisioning NetScaler instances 5 and 3 in this example.

Parameter Name	Values for Instance 5	Values for Instance 3
Name	vpx5	vpx3
IP Address	10.1.3.2	10.1.200.2
Netmask	255.255.255.0	255.255.255.240
Gateway	10.1.3.1	10.1.200.1
XVA File	NS-VPX-XEN-10.0-51.308.a_nc.xva	NS-VPX-XEN-10.0-51.308.a_nc.xva
Feature License	Platinum	Platinum
Admin Profile	ns_nsroot_profile	ns_nsroot_profile
User Name	vpx5	vpx3
Password	Sdx1	root
Confirm Password	Sdx1	root
Shell/Sftp/Scp Access	True	True
Total Memory (MB)	2048	2048
#SSL Chips	1	1
Throughput (Mbps)	1000	1000
Packets per second	1000000	1000000
CPU	Shared	Shared
Interface	1/1 and 10/4	1/1 and 1/5

Parameter Name	Values for Instance 5	Values for Instance 3
NSVLAN	200	100
Add (interface)	1/1	1/1
Tagged Interface	Select <b>Tagged</b>	Select <b>Tagged</b>

### To provision NetScaler instances 5 and 3 as shown in this example

1. On the **Configuration** tab, in the navigation pane, expand **NetScaler Configuration**, and then click **Instances**.
2. In the NetScaler instances pane, click **Add**.
3. In the **Provision NetScaler Wizard** follow the instructions in the wizard to set the parameters to the values shown in the preceding table.
4. Click **Create**, and then click **Close**. The NetScaler instance you provisioned appears in the NetScaler instances pane.

## Consolidation with sharing of a physical port by more than one instance

August 1, 2023

You can enable and disable VLAN filtering on an interface as required. For example, to configure more than 100 VLANs on an instance, assign a dedicated physical interface to that instance and disable VLAN filtering on that interface. Enable VLAN filtering on instances that share a physical interface, so that one instance cannot see the traffic for another instance.

**Note:** VLAN filtering is not a global setting on the appliance. You enable or disable VLAN filtering on an interface, and the setting applies to all instances associated with that interface. If VLAN filtering is disabled, you can configure up to 4096 VLANs. If VLAN filtering is enabled, you can configure up to 63 tagged VLANs on a 10G interface and up to 32 tagged VLANs on a 1G interface.

In the following example, the instances are part of multiple networks.

- Interface 1/1 is assigned as a management interface to all the instances. Interface 0/1 is assigned to the Management Service, which is part of the internal 10.1.1.x network.
- NetScaler instances 2 and 3 are in the 10.1.200.x network, and instances 4, 5, 6, and 7 are in the 10.1.3.x network. Instances 2 and 3 each have a dedicated physical interface. Instances 4 and 7 share physical interface 1/7, and instances 5 and 6 share physical interface 10/4.

- VLAN filtering is enabled on interface 1/7. Traffic for Instance 4 is tagged for VLAN 4, and traffic for Instance 7 is tagged for VLAN 7. As a result, traffic for Instance 4 is not visible to Instance 7. Conversely, traffic for Instance 7 is not visible to Instance 4. A maximum of 32 VLANs can be configured on interface 1/7.
- VLAN filtering is disabled on interface 10/4, so you can configure up to 4096 VLANs on that interface. Configure VLANs 500–599 on Instance 5 and VLANs 600–699 on Instance 6. Instance 5 can see the broadcast and multicast traffic from VLAN 600–699, but the packets are dropped at the software level. Similarly, Instance 6 can see the broadcast and multicast traffic from VLAN 500–599, but the packets are dropped at the software level.

The following figure illustrates the preceding use case.

Figure 1. Network topology of an SDX appliance with Management Service and NetScaler instances distributed across networks

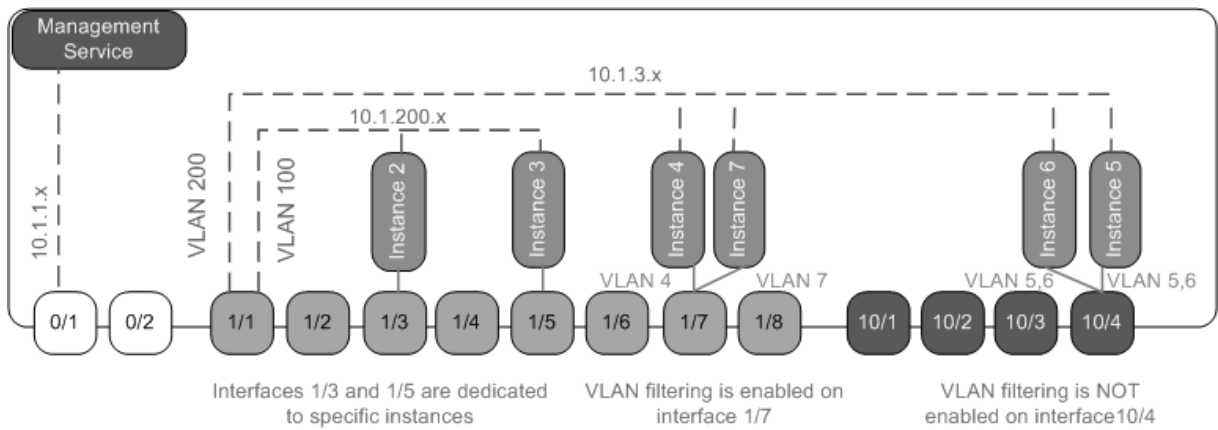

The following table lists the names and values of the parameters used for provisioning NetScaler instances 7 and 4 in this example.

Parameter Name	Values for Instance 7	Values for Instance 4
Name	vpx7	vpx4
IP Address	10.1.3.7	10.1.3.4
Netmask	255.255.255.0	255.255.255.240
Gateway	10.1.3.1	10.1.3.1
XVA File	NS-VPX-XEN-10.0-51.308.a_nc.xva	NS-VPX-XEN-10.0-51.308.a_nc.xva
Feature License	Platinum	Platinum
Admin Profile	ns_nsroot_profile	ns_nsroot_profile
User Name	vpx4	vpx4



---

Parameter Name	Values for Instance 7	Values for Instance 4
Password	Sdx1	Sdx1
Confirm Password	Sdx1	Sdx1
Shell/Sftp/Scp Access	True	True
Total Memory (MB)	2048	2048
#SSL Chips	1	1
Throughput (Mbps)	1000	1000
Packets per second	1000000	1000000
CPU	Shared	Shared
Interface	1/1 and 1/7	1/1 and 1/7
NSVLAN	200	200

---

### To provision NetScaler instances 7 and 4 in this example

1. On the **Configuration** tab, in the navigation pane, expand NetScaler Configuration, and then click **Instances**.
2. In the NetScaler instances pane, click **Add**.
3. In the Provision NetScaler Wizard follow the instructions in the wizard to set the parameters to the values shown in the preceding table.
4. Click **Create**, and then click **Close**. The NetScaler instance you provisioned appears in the NetScaler instances pane.

## NITRO API

August 1, 2023

The NetScaler SDX NITRO protocol allows you to configure and monitor the SDX appliance programmatically.

NITRO exposes its functionality through Representational State Transfer (REST) interfaces. Therefore, NITRO applications can be developed in any programming language. Also, for applications that must be developed in Java or .NET or Python, the NITRO protocol is exposed as relevant libraries that are packaged as separate Software Development Kits.

Note: You must have a basic understanding of the SDX appliance before using NITRO.

To use the NITRO protocol, the client application needs the following:

- Access to an SDX appliance.
- To use REST interfaces, you must have a system to generate HTTP or HTTPS requests (payload in JSON format) to the SDX appliance. You can use any programming language or tool.
- For Java clients, you must have a system where Java Development Kit (JDK) 1.5 or above version is available. The JDK can be downloaded from <http://www.oracle.com/technetwork/java/javase/downloads/index.html>.
- For .NET clients, you must have a system where .NET framework 3.5 or above version is available. The .NET framework can be downloaded from <http://www.microsoft.com/downloads/en/default.aspx>.
- For Python clients, you must have a system where Python 2.7 or above version and the Requests library (available in <NITRO\_SDK\_HOME>/lib) is installed.

## Obtaining the NITRO Package

August 1, 2023

The NITRO package is available as a tar file on the Downloads page of the SDX appliance's configuration utility. You must download and un-tar the file to a folder on your local system. This folder is referred to as <NITRO\_SDK\_HOME> in this documentation.

The folder contains the NITRO libraries in the lib subfolder. The libraries must be added to the client application classpath to access NITRO functionality. The <NITRO\_SDK\_HOME> folder also provides samples and documentation that can help you understand the NITRO SDK.

Note:

- The REST package contains only documentation for using the REST interfaces.
- For the Python SDK, the library must be installed on the client path. For installation instructions, read the \<NITRO\\_SDK\\_HOME>/README.txt file.

## .NET SDK

August 1, 2023

SDX NITRO APIs are categorized depending on the scope and purpose of the APIs into system APIs and configuration APIs. You can also troubleshoot NITRO operations.

## System APIs

The first step towards using NITRO is to establish a session with the SDX appliance and then authenticate the session by using the administrator's credentials.

Create an object of the `nitro_service` class by specifying the IP address of the appliance and the protocol to connect to the appliance (HTTP or HTTPS). You then use this object and log on to the appliance by specifying the user name and the password of the administrator.

Note: You must have a user account on that appliance. The configuration operations that you can perform are limited by the administrative role assigned to your account.

The following sample code connects to an SDX appliance with IP address 10.102.31.16 by using the HTTPS protocol:

```
1 //Specify the IP address of the appliance and service type
2 nitro_service nitroservice = new nitro_service ("10.102.31.16", "https"
   );
3
4 //Specify the login credentials
5 nitroservice.login("nsroot", "verysecret");
6 <!--NeedCopy-->
```

**Note:** Use the `nitro_service` object in all further NITRO operations on the appliance.

To disconnect from the appliance, invoke the `logout()` method as follows:

```
1 nitroservice.logout();
2 <!--NeedCopy-->
```

## Configuration APIs

The NITRO protocol can be used to configure the resources of the SDX appliance.

The APIs to configure a resource are grouped into packages or namespaces that have the format `com.citrix.sdx.nitro.resource.config..` Each of these packages or namespaces contains a class named that provides the APIs to configure the resource.

For example, the NetScaler resource has the `com.citrix.sdx.nitro.resource.config.ns` package or namespace.

A resource class provides APIs to perform other operations. These operations can be creating a resource, retrieving resources and resource properties, updating a resource, deleting resources, and performing bulk operations on resources.

## Create a resource

To create a resource (for example, a NetScaler instance) on the SDX appliance:

1. Set the value for the required properties of the resource by using the corresponding property name. The result is a resource object that contains the details required for the resource.  
Note: These values are set locally on the client. The values are not reflected on the appliance until the object is uploaded.
2. Upload the resource object to the appliance, using the static add() method.

The following sample code creates a NetScaler instance named “ns\_instance” on the SDX appliance:

```
1 ns newns = new ns();
2
3 //Set the properties of the NetScaler locally
4 newns.name = "ns_instance";
5 newns.ip_address = "10.70.136.5";
6 newns.netmask = "255.255.255.0";
7 newns.gateway = "10.70.136.1";
8 newns.image_name = "nsvpx-9.3.45_nc.xva";
9 newns.profile_name = "ns_nsroot_profile";
10 newns.vm_memory_total = 2048;
11 newns.throughput = 1000;
12 newns.pps = 1000000;
13 newns.license = "Standard";
14 newns.username = "admin";
15 newns.password = "admin";
16
17 int number_of_interfaces = 2;
18 network_interface[] interface_array = new network_interface[
    number_of_interfaces];
19
20 //Adding 10/1
21 interface_array[0] = new network_interface();
22 interface_array[0].port_name = "10/1";
23
24 //Adding 10/2
25 interface_array[1] = new network_interface();
26 interface_array[1].port_name = "10/2";
27
28 newns.network_interfaces = interface_array;
29
30 //Upload the NetScaler instance
31 ns result = ns.add(nitroservice, newns);
32 <!--NeedCopy-->
```

## Retrieve resource details

To retrieve the properties of a resource on the SDX appliance, do the following:

1. Retrieve the configurations from the appliance by using the `get()` method. The result is a resource object.
2. Extract the required property from the object by using the corresponding property name.

The following sample code retrieves the details of all NetScaler resources:

```
1 //Retrieve the resource object from the SDX appliance
2 ns[] returned_ns = ns.get(nitroservice);
3
4 //Extract the properties of the resource from the object
5 Console.WriteLine(returned_ns[i].ip_address);
6 Console.WriteLine(returned_ns[i].netmask);
7 <!--NeedCopy-->
```

### Retrieve resource statistics

An SDX appliance collects statistics on the usage of its features. You can retrieve these statistics using NITRO.

The following sample code retrieves the statistics of a NetScaler instance with ID 123456a:

```
1 ns obj = new ns();
2 obj.id = "123456a";
3 ns stats = ns.get(nitroservice, obj);
4 Console.WriteLine("CPU Usage:" + stats.ns_cpu_usage);
5 Console.WriteLine("Memory Usage:" + stats.ns_memory_usage);
6 Console.WriteLine("Request rate/sec:" + stats.http_req);
7 <!--NeedCopy-->
```

### Update a resource

To update the properties of an existing resource on the appliance, do the following:

1. Set the `id` property to the ID of the resource to be updated.
2. Set the value for the required properties of the resource by using the corresponding property name. The result is a resource object.  
Note: These values are set locally on the client. The values are not reflected on the appliance until the object is uploaded.
3. Upload the resource object to the appliance, using the `update()` method.

The following sample code updates the name of the NetScaler instance with ID 123456a to 'ns\_instance\_new':

```
1 ns update_obj = new ns();
2
3 //Set the ID of the NetScaler to be updated
```

```
4 update_obj.id = "123456a";
5
6 //Get existing NetScaler details
7 update_obj = ns.get(nitroservice, update_obj);
8
9 //Update the name of the NetScaler to "ns_instance_new" locally
10 update_obj.name = "ns_instance_new";
11
12 //Upload the updated NetScaler details
13 ns result = ns.update(nitroservice, update_obj);
14 <!--NeedCopy-->
```

### Delete a resource

To delete an existing resource, invoke the static method `delete()` on the resource class, by passing the ID of the resource to be removed, as an argument.

The following sample code deletes a NetScaler instance with ID 1:

```
1 ns obj = new ns();
2 obj.id = "123456a";
3 ns.delete(nitroservice, obj);
4 <!--NeedCopy-->
```

### Bulk operations

You can query or change multiple resources simultaneously and thus minimize network traffic. For example, you can add multiple NetScaler SDX appliances in the same operation.

Each resource class has methods that take an array of resources for adding, updating, and removing resources. To perform a bulk operation, specify the details of each operation locally and then send the details at one time to the server.

To account for the failure of some operations within the bulk operation, NITRO allows you to configure one of the following behaviors:

- **Exit.** When the first error is encountered, the execution stops. The commands that were run before the error are committed.
- **Continue.** All the commands in the list are run even if some commands fail.

**Note:** Configure the required behavior while establishing a connection with the appliance, by setting the

`onerror` param in the `nitro_service()` method.

The following sample code adds two ADC appliances in one operation:

```
1 ns[] newns = new ns[2];
2
3 //Specify details of first NetScaler
4 newns[0] = new ns();
5 newns[0].name = "ns_instance1";
6 newns[0].ip_address = "10.70.136.5";
7 newns[0].netmask = "255.255.255.0";
8 newns[0].gateway = "10.70.136.1";
9 ...
10 ...
11
12 //Specify details of second NetScaler
13 newns[1] = new ns();
14 newns[1].name = "ns_instance2";
15 newns[1].ip_address = "10.70.136.8";
16 newns[1].netmask = "255.255.255.0";
17 newns[1].gateway = "10.70.136.1";
18 ...
19 ...
20
21 //upload the details of the ADC appliances to the NITRO server
22 ns[] result = ns.add(nitroservice, newns);
23 <!--NeedCopy-->
```

## Exception handling

The error code field indicates the status of the operation.

- An error code of 0 indicates that the operation is successful.
- A non-zero error code indicates an error in processing the NITRO request.

The error message field provides a brief explanation and the nature of the failure.

The `com.citrix.sdx.nitro.exception.nitro_exception` class catches all the exceptions in the execution of NITRO APIs. To get information about the exception, you can use the `getErrorCode()` method.

For a more detailed description of the error codes, see the API reference available in the < [NITRO\\_SDK\\_HOME](#)>/doc folder.

## REST web services

August 1, 2023

REST (Representational State Transfer) is an architectural style based on simple HTTP requests and responses between the client and the server. REST is used to query or change the state of objects on

the server side. In REST, the server side is modeled as a set of entities where each entity is identified by a unique URL.

Each resource also has a state on which the following operations can be performed:

- **Create.** Clients can create new server-side resources on a “container” resource. You can think of container resources as folders, and child resources as files or subfolders. The calling client provides the state for the resource to be created. The state can be specified in the request by using XML or JSON format. The client can also specify the unique URL that identifies the new object. Alternatively, the server can choose and return a unique URL identifying the created object. The HTTP method used for create requests is POST.
- **Read.** Clients can retrieve the state of a resource by specifying its URL with the HTTP GET method. The response message contains the resource state, expressed in JSON format.
- **Update.** You can update the state of an existing resource by specifying the URL that identifies that object and its new state in JSON or XML, using the PUT HTTP method.
- **Delete.** You can destroy a resource that exists on the server-side by using the DELETE HTTP method and the URL identifying the resource to be removed.

In addition to these four CRUD operations (Create, Read, Update, and Delete), resources can support other operations or actions. These operations use the HTTP POST method, with the request body in JSON specifying the operation to be performed and parameters for that operation.

SDX NITRO APIs are categorized depending on the scope and purpose of the APIs into system APIs and configuration APIs.

## System APIs

The first step towards using NITRO is to establish a session with the SDX appliance and then authenticate the session by using the administrator’s credentials.

Specify the user name and password in the login object. The session ID that is created must be specified in the request header of all further operations in the session.

Note: You must have a user account on that appliance. The configurations that you can perform are limited by the administrative role assigned to your account.

To connect to an SDX appliance with IP address 10.102.31.16 by using the HTTPS protocol:

- **URL** `https://10.102.31.16/nitro/v2/config/login/`
- **HTTP Method** POST
- **Request**

- **Header**

```
1 Content-Type:application/vnd.com.citrix.sdx.login+json
2 <!--NeedCopy-->
```



**Note:** Content types such as ‘application/x-www-form-urlencoded’ that were supported in earlier versions of NITRO can also be used. Ensure that the payload is the same as used in earlier versions. The payloads provided in this documentation are only applicable if the content type is of the form ‘application/vnd.com.citrix.sdx.login+json’.

#### - Payload

```
1  {
2
3      "login":
4      {
5
6          "username": "nsroot",
7          "password": "verysecret"
8      }
9
10 }
11
12 <!--NeedCopy-->
```

#### • Response Payload

##### - Header

```
1  HTTP/1.0 201 Created
2  Set-Cookie:
3  NITRO_AUTH_TOKEN=##87305E9C51B06C848F0942; path=/nitro/v2
4  <!--NeedCopy-->
```

**Note:** Use the session ID in all further NITRO operations on the appliance.

**Note:** By default, the connection to the appliance expires after 30 minutes of inactivity. You can modify the timeout period by specifying a new timeout period (in seconds) in the login object. For example, to modify the timeout period to 60 minutes, the request payload is:

```
1  {
2
3      "login":
4      {
5
6          "username": "nsroot",
7          "password": "verysecret",
8          "timeout": 3600
9      }
10 }
11
12
13 <!--NeedCopy-->
```

You can also connect to the appliance to perform a single operation, by specifying the user name and password in the request header of the operation. For example, to connect to an appliance while

creating a NetScaler instance:

- **URL**
- **HTTP Method**
- **Request**

- **Header**

```
1 X-NITRO-USER:nsroot
2 X-NITRO-PASS:verysecret
3 Content-Type:application/vnd.com.citrix.sdx.ns+json
4 <!--NeedCopy-->
```

- **Payload**

```
1 {
2
3   "ns":
4     {
5
6       ...
7     }
8
9   }
10
11 <!--NeedCopy-->
```

- **Response.**

- **Header**

```
1 HTTP/1.0 201 Created
2 <!--NeedCopy-->
```

To disconnect from the appliance, use the DELETE method:

- **URL**
- **HTTP Method** DELETE
- **Request**

- **Header**

```
1 Cookie:NITRO_AUTH_TOKEN=tokenvalue
2 Content-Type:application/vnd.com.citrix.sdx.login+json
3 <!--NeedCopy-->
```

## Configuration APIs

The NITRO protocol can be used to configure the resources of the SDX appliance.

Each SDX resource has a unique URL associated with it, depending on the type of operation to be performed. URLs for configuration operations have the format: `http://<IP>/nitro/v2/config/<resource_type>`

### Create a resource

To create a resource (for example, a NetScaler instance) on the SDX appliance, specify the resource name and other related arguments in the specific resource object. For example, to create a NetScaler instance named `vp1`:

- **URL**
- **HTTP Method**
- **Request**

#### - Header

```
1 Cookie:NITRO_AUTH_TOKEN=tokenvalue
2 Content-Type:application/vnd.com.citrix.sdx.ns+json
3 <!--NeedCopy-->
```

#### - Payload

```
1 {
2
3   "ns":
4   {
5
6     "name":"vp1",
7     "ip_address":"192.168.100.2",
8     "netmask":"255.255.255.0",
9     "gateway":"192.168.100.1",
10    "image_name":"nsvpx-9.3-45_nc.xva",
11    "vm_memory_total":2048,
12    "throughput":1000,
13    "pps":1000000,
14    "license":"Standard",
15    "profile_name":"ns_nsroot_profile",
16    "username":"admin",
17    "password":"admin",
18    "network_interfaces":
19    [
20      {
21
22        "port_name":"10/1"
23      }
24    ,
25      {
26
27        "port_name":"10/2"
28      }
29    ]
30  }
31 }
```

```
29
30     ]
31   }
32
33 }
34
35 <!--NeedCopy-->
```

## Retrieve resource details and statistics

SDX resource details can be retrieved as follows:

- To retrieve details of a specific resource on the SDX appliance, specify the id of the resource in the URL.
- To retrieve the properties of resources based on some filter, specify the filter conditions in the URL.

The URL has the form: `http://<IP>/nitro/v2/config/<resource_type>?filter=<property1>:<value>,<property2>:<value>`

- If your request is likely to result in many resources returned from the appliance, you can retrieve these results in chunks by dividing them into “pages” and retrieving them page by page.

For example, assume that you want to retrieve all NetScaler instances on an SDX that has 53 of them. Instead of retrieving all 53 in one large response, configure the results to be divided into pages of 10 NetScaler instances each (6 pages total). Then, retrieve them from the server page by page.

You specify the page count with the page size query string parameter and use the page number query string parameter to specify the page number that you want to retrieve.

The URL has the form: `http://<IP>/nitro/v2/config/<resource_type>?pageno=<value>&pagesize=<value>`

You do not have to retrieve all the pages, or retrieve the pages in order. Each request is independent, and you can even change the page size setting between requests.

**Note:** To have an idea of the number of resources that are likely to be returned by a request, you can use the count query string parameter to ask for a count of the resources to be returned, rather than the resources themselves. To get the number of NetScaler instances available, the URL would be

`http://<IP>/nitro/v2/config/<resource_type>?count=yes`

To retrieve the configuration information for the NetScaler instance with ID 123456a:

- **URL**
- **HTTP Method** GET

## Update a resource

To update an existing SDX resource, use the PUT HTTP method. In the HTTP request payload, specify the name and the other arguments that have to be changed. For example, to change the name of the NetScaler instance with ID 123456a to vpx2:

- **URL**
- **HTTP Method**
- **Request Payload**

- **Header**

```
1 Cookie:NITRO_AUTH_TOKEN=tokenvalue
2 Content-Type:application/vnd.com.citrix.sdx.ns+json
3 <!--NeedCopy-->
```

- **Payload**

```
1 {
2
3   "ns":
4   {
5
6     "name":"vpx2",
7     "id":"123456a"
8   }
9
10  }
11
12 <!--NeedCopy-->
```

## Delete a resource

To delete an existing resource, specify the name of the resource to be deleted in the URL. For example, to delete a NetScaler instance with ID 123456a:

- **URL**
- **HTTP Method**
- **Request**

- **Header**

```
1 Cookie:NITRO_AUTH_TOKEN=tokenvalue
2 Content-Type:application/vnd.com.citrix.sdx.ns+json
3 <!--NeedCopy-->
```

## Bulk operations

You can query or change multiple resources simultaneously and thus minimize network traffic. For example, you can add multiple NetScaler SDX appliances in the same operation. You can also add resources of different types in one request.

To account for the failure of some operations within the bulk operation, NITRO allows you to configure one of the following behaviors:

- **Exit.** When the first error is encountered, the execution stops. The commands that were run before the error are committed.
- **Continue.** All the commands in the list are run even if some commands fail.

**Note:** Configure the required behavior in the request header using the `X-NITRO-ONERROR` parameter.

To add 2 NetScaler resources in one operation and continue if one command fails:

- **URL.**
- **HTTP Method.**
- **Request Payload.**

### - Header

```
1 Cookie:NITRO_AUTH_TOKEN=tokenvalue
2 Content-Type:application/vnd.com.citrix.sdx.ns+json
3 X-NITRO-ONERROR:continue
4 <!--NeedCopy-->
```

### - Payload

```
1 {
2
3   "ns":
4   [
5     {
6
7       "name":"ns_instance1",
8       "ip_address":"10.70.136.5",
9       "netmask":"255.255.255.0",
10      "gateway":"10.70.136.1"
11    }
12  ,
13    {
14
15      "name":"ns_instance2",
16      "ip_address":"10.70.136.8",
17      "netmask":"255.255.255.0",
18      "gateway":"10.70.136.1"
19    }
20  ]
}
```

```
21     ]
22   }
23
24   <!--NeedCopy-->
```

To add multiple resources (NetScaler and two MPS users) in one operation and continue if one command fails:

- **URL.**
- **HTTP Method.** POST
- **Request Payload.**

- **Header**

```
1  Cookie:NITRO_AUTH_TOKEN=tokenvalue
2  Content-Type:application/vnd.com.citrix.sdx.ns+json
3  X-NITRO-ONERROR:continue
4  <!--NeedCopy-->
```

- **Payload**

```
1  {
2
3     "ns":
4     [
5         {
6
7             "name":"ns_instance1",
8             "ip_address":"10.70.136.5",
9             "netmask":"255.255.255.0",
10            "gateway":"10.70.136.1"
11        }
12    ,
13        {
14
15            "name":"ns_instance2",
16            "ip_address":"10.70.136.8",
17            "netmask":"255.255.255.0",
18            "gateway":"10.70.136.1"
19        }
20    ],
21    "mpsuser":
22    [
23        {
24
25            "name":"admin",
26            "password":"admin",
27            "permission":"superuser"
28        }
29    ],
30    {
31
```

```
32
33     "name": "admin",
34     "password": "admin",
35     "permission": "superuser"
36   }
37
38 ]
39 }
40
41 <!--NeedCopy-->
```

## Exception Handling

The error code field indicates the status of the operation.

- An error code of 0 indicates that the operation is successful.
- A non-zero error code indicates an error in processing the NITRO request.

The error message field provides a brief explanation and the nature of the failure.

## How NITRO Works

August 1, 2023

The NITRO infrastructure consists of a client application and the NITRO web service running on a NetScaler SDX appliance. The communication between the client application and the NITRO web service is based on REST architecture using HTTP or HTTPS.

Figure 1. NITRO workflow

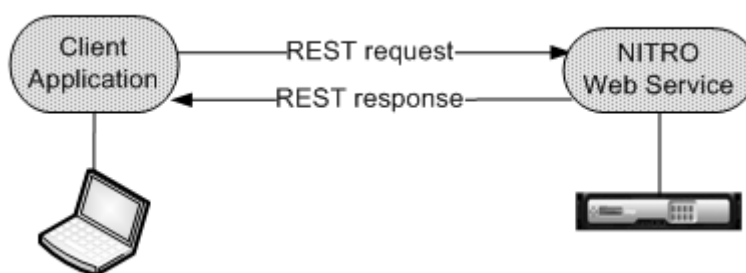

Steps detailing the workflow:

1. The client application sends a REST request message to the NITRO web service. When using the SDKs, an API call is translated into the appropriate REST request message.
2. The web service processes the REST request message.



3. The NITRO web service returns the corresponding REST response message to the client application. When using the SDKs, the REST response message is translated into the appropriate response for the API call.

To minimize traffic on the network, retrieve the whole state of a resource from the server. Make modifications to the state of the resource locally. Then upload it back to the server in one network transaction.

**Note:** Local operations on a resource (changing its properties) do not affect its state on the server until the state of the object is explicitly uploaded.

NITRO APIs are synchronous in nature. That is, the client application waits for a response from the NITRO web service before running another NITRO API.

## Java SDK

August 1, 2023

SDX NITRO APIs are categorized depending on the scope and purpose of the APIs into system APIs and configuration APIs. You can also troubleshoot NITRO operations.

### System APIs

The first step towards using NITRO is to establish a session with the SDX appliance and then authenticate the session by using the administrator's credentials.

Create an object of the `nitro_service` class by specifying the IP address of the appliance and the protocol to connect to the appliance (HTTP or HTTPS). You then use this object and log on to the appliance by specifying the user name and the password of the administrator.

**Note:** You must have a user account on that appliance. The configuration operations that you can perform are limited by the administrative role assigned to your account.

The following sample code connects to an SDX appliance with IP address 10.102.31.16 by using the HTTPS protocol:

```
1 //Specify the IP address of the appliance and service type
2 nitro_service nitroservice = new nitro_service ("10.102.31.16", "https"
3 );
4 //Specify the login credentials
5 nitroservice.login("nsroot", "verysecret");
6 <!--NeedCopy-->
```

**Note:** Use the `nitro_service` object in all further NITRO operations on the appliance.

To disconnect from the appliance, invoke the `logout()` method as follows:

```
1 nitroservice.logout();
2 <!--NeedCopy-->
```

## Configuration APIs

The NITRO protocol can be used to configure the resources of the SDX appliance.

The APIs to configure a resource are grouped into packages or namespaces that have the format `com.citrix.sdx.nitro.resource.config..` Each of these packages or namespaces contains a class named that provides the APIs to configure the resource.

For example, the NetScaler resource has the `com.citrix.sdx.nitro.resource.config.ns` package or namespace.

A resource class provides APIs to perform many other operations. These operations can be creating a resource, retrieving resource details and statistics, updating a resource, deleting resources, and performing bulk operations on resources.

## Creating a Resource

To create a resource (for example, a NetScaler instance) on the SDX appliance, do the following:

1. Set the value for the required properties of the resource by using the corresponding property name. The result is a resource object that contains the details required for the resource.  
Note: These values are set locally on the client. The values are not reflected on the appliance until the object is uploaded.
2. Upload the resource object to the appliance, using the static `add()` method.

The following sample code creates a NetScaler instance named “`ns_instance`” on the SDX appliance:

```
1 ns newns = new ns();
2
3 //Set the properties of the NetScaler locally
4 newns.set_name("ns_instance");
5 newns.set_ip_address("10.70.136.5");
6 newns.set_netmask("255.255.255.0");
7 newns.set_gateway("10.70.136.1");
8 newns.set_image_name("nsvpx-9.3.45_nc.xva");
9 newns.set_profile_name("ns_nsroot_profile");
10 newns.set_vm_memory_total(new Double(2048));
11 newns.set_throughput(new Double(1000));
12 newns.set_pps(new Double(1000000));
```

```
13 newns.set_license("Standard");
14 newns.set_username("admin");
15 newns.set_password("admin");
16
17 int number_of_interfaces = 2;
18 network_interface[] interface_array = new network_interface[
    number_of_interfaces];
19
20 //Adding 10/1
21 interface_array[0] = new network_interface();
22 interface_array[0].set_port_name("10/1");
23
24 //Adding 10/2
25 interface_array[1] = new network_interface();
26 interface_array[1].set_port_name("10/2");
27
28 newns.set_network_interfaces(interface_array);
29
30 //Upload the NetScaler instance
31 ns result = ns.add(nitroservice, newns);
32 <!--NeedCopy-->
```

### Retrieving Resource Details

To retrieve the properties of a resource on the SDX appliance, do the following:

1. Retrieve the configurations from the appliance by using the `get()` method. The result is a resource object.
2. Extract the required property from the object by using the corresponding property name.

The following sample code retrieves the details of all NetScaler resources:

```
1 //Retrieve the resource object from the SDX appliance
2 ns[] returned_ns = ns.get(nitroservice);
3
4 //Extract the properties of the resource from the object
5 System.out.println(returned_ns[i].get_ip_address());
6 System.out.println(returned_ns[i].get_netmask());
7 <!--NeedCopy-->
```

### Retrieving Resource Statistics

An SDX appliance collects statistics on the usage of its features. You can retrieve these statistics using NITRO.

The following sample code retrieves the statistics of a NetScaler instance with ID 123456a:

```
1 ns obj = new ns();
```

```
2 obj.set_id("123456a");
3 ns stats = ns.get(nitroservice, obj);
4 System.out.println("CPU Usage:" + stats.get_ns_cpu_usage());
5 System.out.println("Memory Usage:" + stats.get_ns_memory_usage());
6 System.out.println("Request rate/sec:" +stats.get_http_req());
7 <!--NeedCopy-->
```

## Updating a Resource

To update the properties of an existing resource on the appliance, do the following:

1. Set the id property to the ID of the resource to be updated.
2. Set the value for the required properties of the resource by using the corresponding property name. The result is a resource object.  
Note: These values are set locally on the client. The values are not reflected on the appliance until the object is uploaded.
3. Upload the resource object to the appliance, using the update() method.

The following sample code updates the name of the NetScaler instance with ID 123456a to 'ns\_instance\_new':

```
1 ns update_obj = new ns();
2
3 //Set the ID of the NetScaler to be updated
4 update_obj.set_id("123456a");
5
6 //Get existing NetScaler details
7 update_obj = ns.get(nitroservice, update_obj);
8
9 //Update the name of the NetScaler to "ns_instance_new" locally
10 update_obj.set_name("ns_instance_new");
11
12 //Upload the updated NetScaler details
13 ns result = ns.update(nitroservice, update_obj);
14 <!--NeedCopy-->
```

## Deleting a Resource

To delete an existing resource, invoke the static method delete() on the resource class, by passing the ID of the resource to be removed, as an argument.

The following sample code deletes a NetScaler instance with ID 1:

```
1 ns obj = new ns();
2 obj.set_id("123456a");
3 ns.delete(nitroservice, obj);
4 <!--NeedCopy-->
```

## Bulk Operations

You can query or change multiple resources simultaneously and thus minimize network traffic. For example, you can add multiple NetScaler SDX appliances in the same operation.

Each resource class has methods that take an array of resources for adding, updating, and removing resources. To perform a bulk operation, specify the details of each operation locally and then send the details at one time to the server.

To account for the failure of some operations within the bulk operation, NITRO allows you to configure one of the following behaviors:

- **Exit.** When the first error is encountered, the execution stops. The commands that were run before the error are committed.
- **Continue.** All the commands in the list are run even if some commands fail.

**Note:** Configure the required behavior while establishing a connection with the appliance, by setting the

`onerror` param in the `nitro_service()` method.

The following sample code adds two ADC appliances in one operation:

```
1 ns[] newns = new ns[2];
2
3 //Specify details of first NetScaler
4 newns[0] = new ns();
5 newns[0].set_name("ns_instance1");
6 newns[0].set_ip_address("10.70.136.5");
7 newns[0].set_netmask("255.255.255.0");
8 newns[0].set_gateway("10.70.136.1");
9 ...
10 ...
11 ...
12
13 //Specify details of second NetScaler
14 newns[1] = new ns();
15 newns[1].set_name("ns_instance2");
16 newns[1].set_ip_address("10.70.136.8");
17 newns[1].set_netmask("255.255.255.0");
18 newns[1].set_gateway("10.70.136.1");
19 ...
20 ...
21
22 //upload the details of the NetScalers to the NITRO server
23 ns[] result = ns.add(nitroservice, newns);
24 <!--NeedCopy-->
```

## Exception Handling

The error code field indicates the status of the operation.

- An error code of 0 indicates that the operation is successful.
- A non-zero error code indicates an error in processing the NITRO request.

The error message field provides a brief explanation and the nature of the failure.

The `com.citrix.sdx.nitro.exception.nitro_exception` class catches all exceptions in the execution of NITRO APIs. To get information about the exception, you can use the `getErrorCode()` method.

For a more detailed description of the error codes, see the API reference available in the < [NITRO\\_SDK\\_HOME](#)>/doc folder.



© 2024 Cloud Software Group, Inc. All rights reserved. Cloud Software Group, the Cloud Software Group logo, and other marks appearing herein are property of Cloud Software Group, Inc. and/or one or more of its subsidiaries, and may be registered with the U.S. Patent and Trademark Office and in other countries. All other marks are the property of their respective owner(s).

---